



INTERVENTIONAL
VASCULAR DIAGNOSTICS
AND THERAPY

Celsite[®], Surecan[®], Cytocan[®]

ACCESS PORT SYSTEMS, ACCESSORIES
AND NON-CORING PORT NEEDLES

ACCESS PORT SYSTEMS

IMPLANTATION SITES

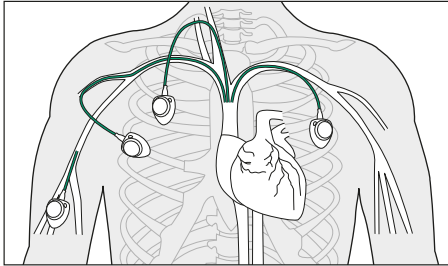

Venous access

for repeated intra-venous administration of, for example, chemotherapy, antibiotics and anti-viral drugs, parenteral nutrition, blood sampling or transfusion

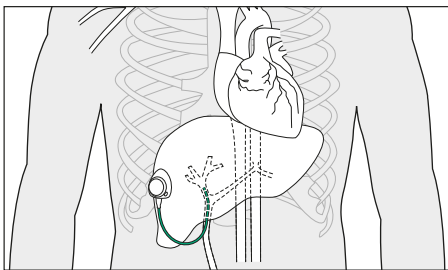

Arterial access

for intra-arterial administration of chemotherapy

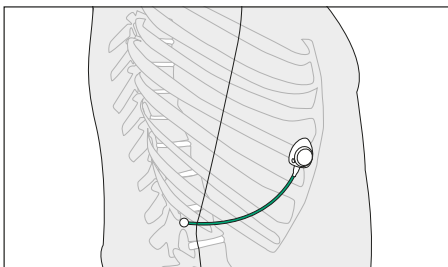

Epidural or intra-thecal access

for spinal administration of pain relieving drugs

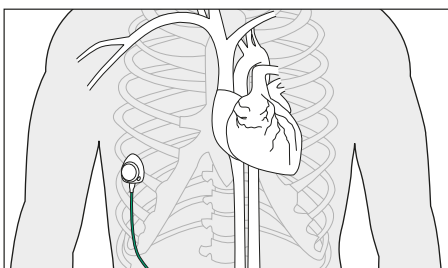

Peritoneal access

for loco-regional chemotherapy and (i. e. with Drainaport[®]) for hydration and drainage of malignant ascites

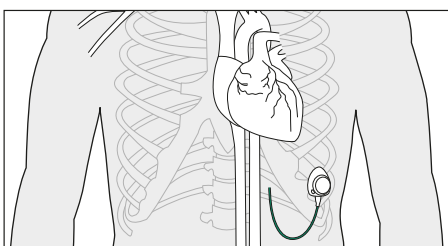

Pleural access

for drainage of malignant pleural effusion (MPE)

CONTENT

	Access Port Systems for venous access		
4 - 5	Celsite® Safety Venous access ports for extended flexibility without compromise on safety		
8 - 9	Celsite® Epoxy Premium venous access ports with special compact port design		
10 - 11	Celsite® ECG Venous access ports for accurate ECG guided catheter positioning		
12 - 13	Celsite® Discreet Venous access ports with unique design for enhanced port stability and better cosmetic results		
14 - 15	Celsite® PSU Venous access ports for mid to long-term venous applications		
16	Celsite® IMPLANTOFIX® Venous access ports with catheter/port screw connection		
17	Celsite® Double Specialized venous access ports with two separate port chambers		
18	Celsite® Valved Venous access ports with valved catheter tip		
	Access Port Systems for arterial access		
19	Celsite® Arterial For hepatic artery infusion therapy (surgical implantation technique)		
	Access Port Systems for peritoneal access		
20	Celsite® Peritoneal For loco-regional chemotherapy of peritoneal metastases and ovarian cancer		
	Access Port Systems for peritoneal/pleural access		
21	Celsite® DRAINAPORT For intra-peritoneal administration of chemotherapy, drainage of malignant ascites, or drainage of pleural effusion		
			Access Port Systems for spinal or epidural access
		22	Celsite® Spinal For spinal administration of pain relieving drugs
			Characteristics, MRI, CECT
		23	Celsite® MR compatibility and high pressure resistance
			Safety Access Port Needles
		24 - 25	Surecan® Safety II High pressure resistant non-coring safety needle for access ports
			Access Port Needles
		26	Winged Surecan® High pressure resistant non-coring safety needle for access ports
		26	Cytocan® Non-coring needle for long term infusions with fixation base
		27	Angled Surecan® Non-coring port needle for short term infusions
		27	Straight Surecan® Non-coring needle for bolus injections or flushing of access ports
			Celsite® Access Port Systems
		28	Recommended maximum flow rates Celsite® Access Ports Systems
		29	Overview and type declaration Celsite® Access Port Systems
		30 - 32	Accessories
		33 - 37	Customized Access Port Kits
		38 - 39	Notes

Celsite® Safety

VENOUS ACCESS PORTS FOR EXTENDED FLEXIBILITY WITHOUT COMPROMISE ON SAFETY



Celsite® Safety is intended to be used in any condition that requires mid to long-term intermittent or continuous central venous infusions.

The anatomic design with a low profiled nose simplifies the insertion and allows the creation of a small port pocket to downsize the trauma

Reduced titanium content

To reduce metal induced artifacts in MRI

PEEK as housing and chamber material

- Poly Ether Ether Ketone - A biocompatible material with high chemical and pressure resistance and excellent durability characteristics.
- Natural color without any additional substances

Titanium bottom plate

High puncture resistance

Titanium exit cannula

Precision in catheter connection

High pressure resistant And Radiopaque CT – marking

- Complete range of Celsite® Safety is resistant to high pressure injections up to 325 psi
- Enables power injections of contrast media
- No need for additional venous access
- Clear identification of high pressure resistance under the x-ray

Large puncture area with high density silicone septum

For simple puncturing and reliable sealing to allow good port life

Extra large suture holes

For easy fixation of the access port with sutures

Lasermarked PUR and silicone catheters

- Clear readability of the catheter length
- No ink is added

Radiopaque connection ring

Anti kink protection and additional fixation of the catheter

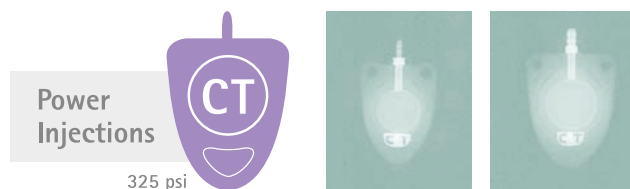

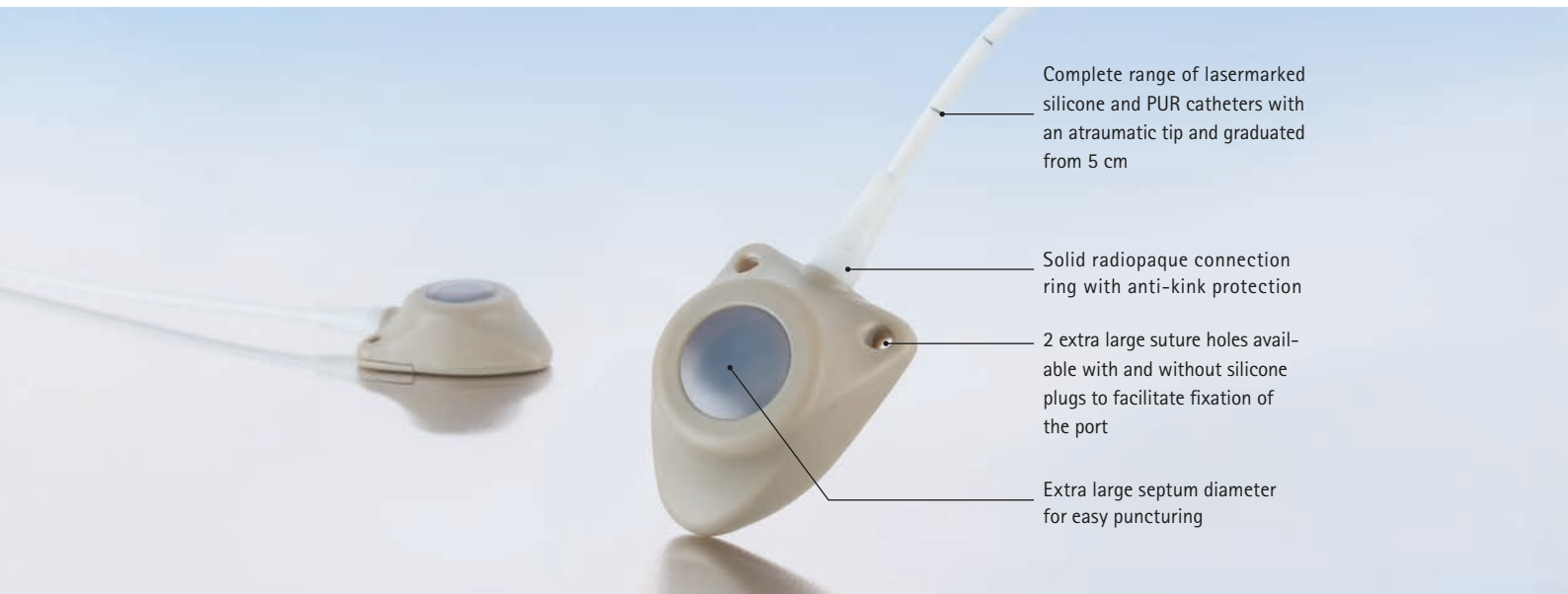

Complete range of lasermarked silicone and PUR catheters with an atraumatic tip and graduated from 5 cm

Solid radiopaque connection ring with anti-kink protection

2 extra large suture holes available with and without silicone plugs to facilitate fixation of the port

Extra large septum diameter for easy puncturing

PEEK and titanium combination as special safety features

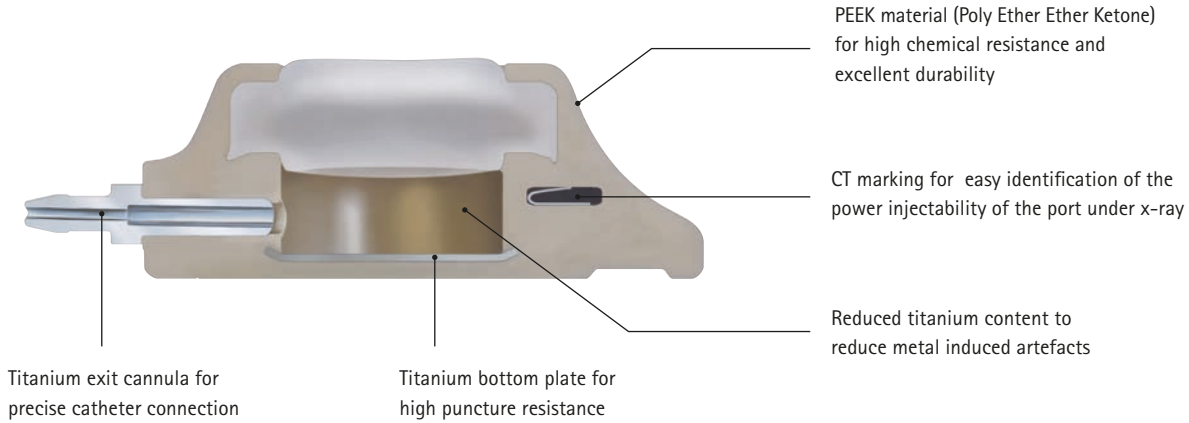

Surecan® Safety II - Port Needle

- Intuitive safety mechanism to reduce the risk of needle stick injuries
- High pressure resistance up to 325 psi



Safecan™ Safety - Puncture Needle

- Safety mechanism to reduce the risk of needle stick injuries
- Echogenic puncture needle for needle tip location via ultrasound



Celsite® Safety

CELSITE® SAFETY OFFERS A WIDE RANGE OF SILICONE AND PUR CATHETERS AS WELL AS TWO DIFFERENT PORT SIZES, STANDARD AND SMALL.

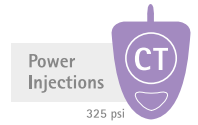

Celsite® Safety with open suture holes

Catheter	OD (F/mm)	ID (mm)	Length (mm)	Flow rate* (ml/min)		Recommended maximum flow rates (mL/s) Contrast media at 37°C (325 psi = 22.4 bar)**			Implantation technique	Type	Reference	Accessories see page 32
						Viscosity up to 11.4 mPa.s (cP)						
						19 G	22 G	19 G				
Standard												
Silicone	6.5 / 2.2	1.1	500	26	10	2	5	5	Surgical cut-down	T601F	4437556	8
Silicone	8.5 / 2.8	1.2	500	34	11	2	5	5	Surgical cut-down	T601L	4437573	8
PUR	6.5 / 2.1	1.4	500	37	12	2	5	5	Surgical cut-down	T601P	4437565	8
PUR	8.5 / 2.8	1.6	500	48	12	2	5	5	Surgical cut-down	T601H	4437581	8
Silicone	6.5 / 2.2	1.1	500	26	10	2	5	5	Seldinger	SST601F	4437603	7
Silicone	8.5 / 2.8	1.2	500	34	11	2	5	5	Seldinger	SST601L	4437612	7
Silicone	10 / 3.2	1.6	500	48	12	2	5	5	Seldinger	SST601G	4437620	7
PUR	6.5 / 2.1	1.4	500	37	12	2	5	5	Seldinger	SST601P	4437607	7
PUR	8.5 / 2.8	1.6	500	48	12	2	5	5	Seldinger	SST601H	4437617	7
Small												
Silicone	6.5 / 2.2	1.1	500	26	10	2	5	5	Surgical cut-down	T605F	4437758	8
Silicone	10 / 3.2	1.6	500	48	12	2	5	5	Surgical cut-down	T605G	4437786	8
Silicone	6.5 / 2.2	1.1	500	26	10	2	5	5	Seldinger	SST605F	4437803	7
Silicone	8.5 / 2.8	1.2	500	34	11	2	5	5	Seldinger	SST605L	4437817	7
Silicone	10 / 3.2	1.6	500	48	12	2	5	5	Seldinger	SST605G	4437822	7
PUR	5 / 1.6	1.1	500	26	10	2	5	5	Seldinger	SST605C	4437800	7
PUR	6.5 / 2.1	1.4	500	37	12	2	5	5	Seldinger	SST605P	4437809	7
PUR	8.5 / 2.8	1.6	500	48	12	2	5	5	Seldinger	SST605H	4437813	7

* Gravity infusion of saline (0.9%) through a 22G respectively 19G needle from a height difference of 1 m and a catheter length of 40 cm. According to ISO 10555-1
 ** Flow rates determined according to ISO 10555-6 with a catheter of 20 cm and Surecan® Safety II 20 mm needle

All Celsite® Safety Ports are PVC, LATEX and DEHP free

PVC FREE	LATEX FREE	DEHP FREE
--------------------	----------------------	---------------------

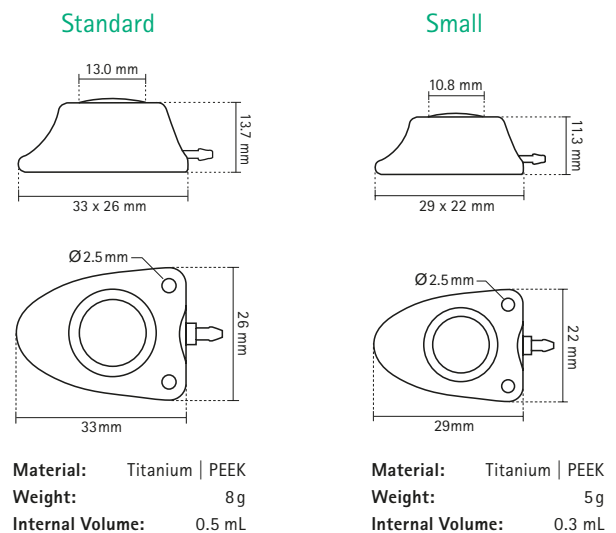

Celsite® Safety

ADDITIONAL REFERENCES WITH ULTRASOUND COVER AND SILICONE PLUGS

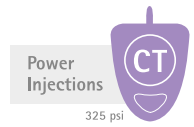

Celsite® Safety with Ultrasound cover

Catheter	OD (F/mm)	ID (mm)	Length (mm)	Flow rate** (ml/min)		Recommended maximum flow rates (mL/s) Contrast media at 37°C (325 psi = 22.4 bar)**			Implantation technique	Type	Reference	Accessories see page 32
				19 G	22 G	Viscosity up to 11.4 mPa.s (cP)						
						22 G	20 G	19 G				
Standard												
Silicone	6.5 / 2.2	1.1	500	26	10	2	5	5	Seldinger	SNT601F (US Probe)	4437592	11
Silicone	8.5 / 2.8	1.2	500	34	11	2	5	5	Seldinger	SNT601L (US Probe)	4437593	11
Small												
Silicone	6.5 / 2.2	1.1	500	26	10	2	5	5	Seldinger	SNT605F (US Probe)	4437594	11
Silicone	8.5 / 2.8	1.2	500	34	11	2	5	5	Seldinger	SNT605L (US Probe)	4437595	11

* Available in CE marked countries

** Gravity infusion of saline (0.9%) through a 22G respectively 19G needle from a height difference of 1 m and a catheter length of 40 cm. According to ISO 10555-1

*** Flow rates determined according to ISO 10555-6 with a catheter of 20 cm and Surecan® Safety II 20 mm needle

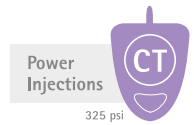

Celsite® Safety with Silicone plugs

Catheter	OD (F/mm)	ID (mm)	Length (mm)	Flow rate* (ml/min)		Recommended maximum flow rates (mL/s) Contrast media at 37°C (325 psi = 22.4 bar)**			Implantation technique	Type	Reference	Accessories see page 32
				19 G	22 G	Viscosity up to 11.4 mPa.s (cP)						
						22 G	20 G	19 G				
Standard												
Silicone	6.5 / 2.2	1.1	500	26	10	2	5	5	Seldinger	SST701F	4437605	7
Silicone	8.5 / 2.8	1.2	500	34	11	2	5	5	Seldinger	SST701L	4437614	7
Silicone	10 / 3.2	1.6	500	48	12	2	5	5	Seldinger	SST701G	4437621	7
PUR	6.5 / 2.1	1.4	500	37	12	2	5	5	Seldinger	SST701P	4437609	7
Silicone	6.5 / 2.2	1.1	500	26	10	2	5	5	Surgical cut-down	T701F	4437560	8
Silicone	8.5 / 2.8	1.2	500	34	11	2	5	5	Surgical cut-down	T701L	4437578	8
Small												
Silicone	6.5 / 2.2	1.1	500	26	10	2	5	5	Seldinger	SST705F	4437805	7
Silicone	8.5 / 2.8	1.2	500	34	11	2	5	5	Seldinger	SST705L	4437818	7
Silicone	10 / 3.2	1.6	500	48	12	2	5	5	Seldinger	SST705G	4437790	7
PUR	5 / 1.6	1.1	500	26	10	2	5	5	Seldinger	SST705C	4437801	7
PUR	6.5 / 2.1	1.4	500	37	12	2	5	5	Seldinger	SST705P	4437807	7
PUR	8.5 / 2.8	1.6	500	48	12	2	5	5	Seldinger	SST705H	4437815	7

* Gravity infusion of saline (0.9%) through a 22G respectively 19G needle from a height difference of 1 m and a catheter length of 40 cm. According to ISO 10555-1

** Flow rates determined according to ISO 10555-6 with a catheter of 20 cm and Surecan® Safety II 20 mm needle

Celsite® Epoxy

PREMIUM VENOUS ACCESS PORTS WITH SPECIAL COMPACT PORT DESIGN

As the premium access port range of B. Braun, Celsite® Epoxy ports offer outstanding features as well as an extended portfolio of different port sizes and catheters.

They are intended to be used for repeated, intravenous administration of, for example, chemotherapy, antibiotic and anti-viral drugs, parenteral nutrition, blood sampling or transfusion.

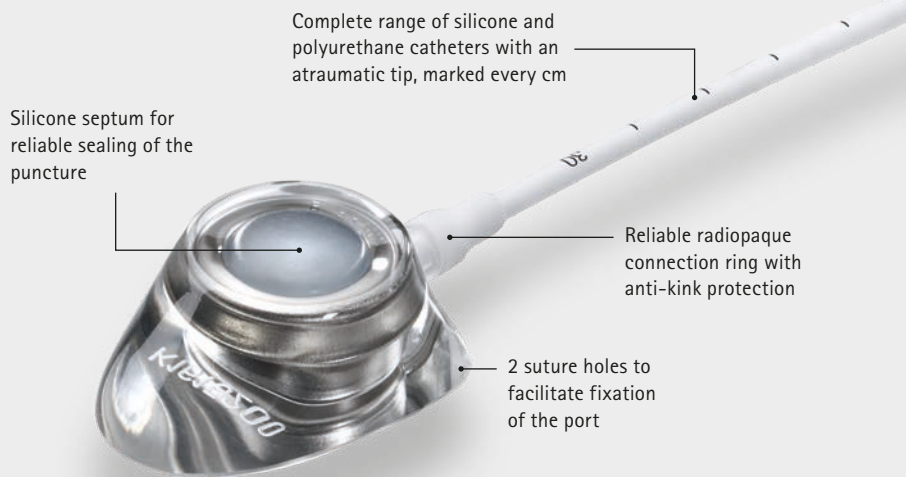

Highly compact design

Celsite® Epoxy ports have an extremely low profile and related to the total dimensions of the port a particularly large septum.



High pressure resistant

The complete range of venous Celsite® Epoxy ports is resistant to high pressure injection up to 325 psi. This enables for power injections of contrast media in radiology, without the need for additional access and needlesticks.

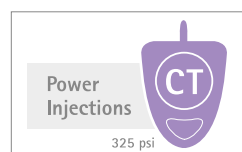

Radiopaque CT Marking

Celsite® Epoxy offers radiopaque CT marking. With CT marking it is possible to identify the port as resistant to high pressure injection in the x-ray image.



Extended Portfolio

Available as extra small Brachial- and Babyport®. One of the most compact access ports commercially available.



Catheter	OD (F/mm)	ID (mm)	Length (mm)	Flow rate* (ml/min)		325 PSI Recommended maximum flow rates (mL/s) Contrast media at 37°C (325 psi = 22.4 bar)**						Implantation technique	Type	Reference	Accessories see page 30/31
						Viscosity 5.8 mPa.s (cP)			Viscosity 11.4 mPa.s (cP)						
						19 G	22 G	22 G	20 G	19 G	22 G				
Standard															
PUR	5 / 1.6	1.1	900	24	10	2	5	6	2	5	6	Seldinger	ST201C	04432045	1
Silicone	6.5/2.2	1.1	800	26	10	2	6	7	2	6	8	Surgical cut-down	T201F	04430034	6
Silicone	6.5/2.2	1.1	800	26	10	2	6	7	2	6	8	Seldinger	ST201F	04430409	1
PUR	6.5/2.1	1.4	800	34	11	2	5	7	2	5	6	Seldinger	ST201P	04430417	1
PUR (high flow)	8.5/2.8	1.6	800	45	12	2	6	8	2	7	9	Seldinger	ST201H	04433149	1
Silicone	8.5/2.8	1.1	800	28	13	2	6	7	2	6	9	Surgical cut-down	T201	04430026	6
Silicone	8.5/2.8	1.1	800	28	13	2	6	7	2	6	9	Seldinger	ST201	04430395	1
Silicone (high flow)	10 / 3.2	1.6	800	47	13	2	6	9	2	6	8	Seldinger	ST201G	04433807	1
Small															
Silicone	6.5/2.2	1.1	800	24	10	2	5	8	2	5	6	Seldinger	ST205	04430893	1
Silicone	6.5/2.2	1.1	800	24	10	2	5	8	2	5	6	Surgical cut-down	T205	04430085	6
PUR	6.5/2.1	1.4	800	30	11	2	5	8	2	5	6	Seldinger	ST205P	04430894	1
Silicone	8.5/2.8	1.1	800	25	10	2	5	8	2	5	7	Seldinger	ST205L	04430895	1
PUR (high flow)	8.5/2.8	1.6	800	37	12	2	6	9	2	5	8	Seldinger	ST205H	04436806	1
Silicone***	6.5/2.2	1.0	800	24	10	2	5	8	2	5	6	Seldinger	ST215	04430143	1
Baby/Brachial															
PUR	4.5/1.5	0.8	800	12	7	2	4	-	2	3	-	Seldinger	Babyport®	04433742	4
PUR	5 / 1.6	1.1	700	22	10	2	5	-	2	4	-	Seldinger, OTW	Brachial	04433734	10
Silicone	6 / 2.0	1.2	600	24	10	2	5	-	2	5	-	Seldinger	Babyport® S	04433842	5

Celsite® Epoxy offers a wide range of Silicone and PUR catheters and three different port sizes, Standard, Small and Baby/Brachial.

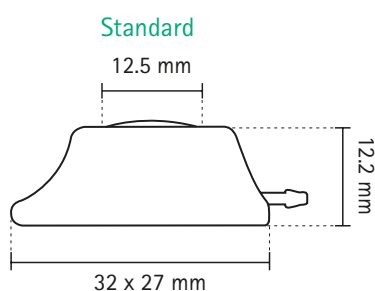

Material: Titanium | Epoxy
Weight: 8g
Internal Volume: 0.5 mL

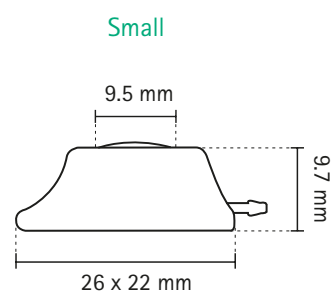

Material: Titanium | Epoxy
Weight: 5g
Internal Volume: 0.25 mL

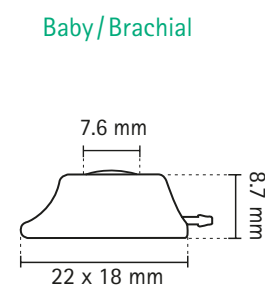

Material: Titanium | Epoxy
Weight: 3g
Internal Volume: 0.15 mL

* Gravity flow rates established by gravity infusion of NaCl 0.9%, height 1m. Catheter length 40cm. According to ISO 10555-1.

** With a catheter of 20 cm and Surecan® Safety II. For countries under CE mark only.

*** With pre-connected catheter.

Celsite® ECG

VENOUS ACCESS PORTS FOR ACCURATE ECG GUIDED CATHETER POSITIONING

- Celsite® ECG allows catheter positioning via intra-atrial ECG detection
- Accurate placement of the catheter tip into the superior vena cava without intraoperative fluoroscopy
- With radiopaque CT marking.

Correct and accurate positioning of the catheter is of high importance to reduce the risk of long term complications.*



* Caers J., Support Care Cancer (2005) 13:325–331

Accepted

Proven in daily clinical routine and numerous clinical trials.

Accurate

Celsite® ECG allows accurate placement of the catheter tip.

Without X-ray

No expensive X-ray equipment needed in almost all cases.
No X-ray exposure for theatre staff and patients.

Compatible

Celsite® ECG can be used with any ECG monitor with no need for additional investment.

The Certodyn® Universal Adapter can be ordered by reference 04150228

Catheter	OD (F/mm)	ID (mm)	Length (mm)	Flow rate* (ml/min)		325 PSI Recommended maximum flow rates (mL/s) Contrast media at 37°C (325 psi = 22.4 bar)**						Implantation technique	Type	Reference	Accessories see page 30/31
						Viscosity 5.8 mPa.s (cP)			Viscosity 11.4 mPa.s (cP)						
				19G	22G	22G	20G	19G	22G	20G	19G				

Standard

Silicone	6.5 / 2.2	1.0	500	26	10	2	6	7	2	6	8	Seldinger	ST201F ECG	04440140	9
Silicone	6.5 / 2.2	1.0	500	26	10	2	6	7	2	6	8	Surgical cutdown	T201F ECG	04440150	14
Silicone	8.5 / 2.8	1.1	500	28	13	2	6	7	2	6	9	Seldinger	ST201 ECG	04430140	9
Silicone	8.5 / 2.8	1.1	500	28	13	2	6	7	2	6	9	Surgical cutdown	T201 ECG	04430150	14

Small

Silicone	6.5 / 2.2	1.0	500	24	10	2	5	8	2	5	6	Seldinger	ST205F ECG	04440111	9
Silicone	6.5 / 2.2	1.0	500	24	10	2	5	8	2	5	6	Surgical cutdown	T205F ECG	04440222	14
Silicone	8.5 / 2.8	1.1	500	25	10	2	5	8	2	5	7	Seldinger	ST205 ECG	04430111	9
Silicone	8.5 / 2.8	1.1	500	25	10	2	5	8	2	5	7	Surgical cutdown	T205 ECG	04430222	14

Localisation

- 1 Maximal P-wave height is reached and maintained when the catheter enters into the right atrium. After identifying the area where the P-wave begins to develop its maximal amplitude (which corresponds anatomically to the junction between superior vena cava and the right atrium) advance the catheter a further 2 cm.
- 2 This is the final position of the catheter tip with the patient in supine position. This catheter position allows for the 2-3 cm cranial movement of the catheter tip which occurs when the patient is upright.

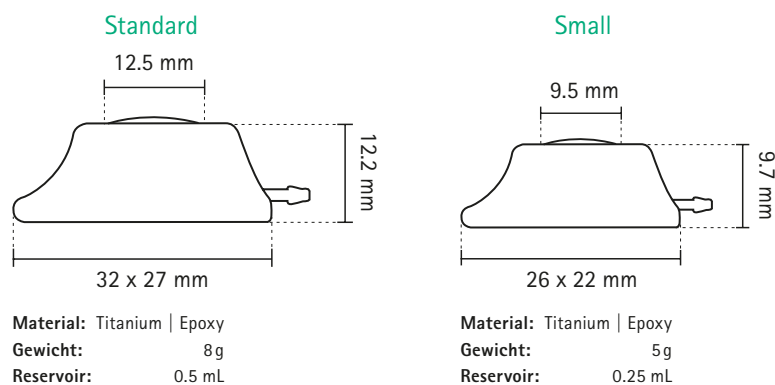
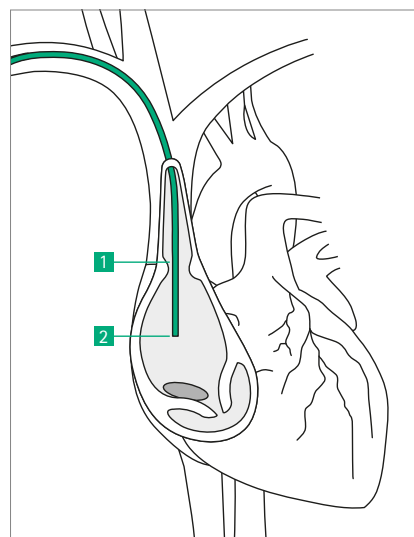

* Gravity flow rates established by gravity infusion of NaCl 0.9%, height 1m. Catheter length 40cm. According to ISO 10555-1.

** With a catheter of 20 cm and Surecan® Safety II. For countries under CE mark only.

Celsite® Discreet

VENOUS ACCESS PORTS WITH UNIQUE DESIGN FOR ENHANCED PORT STABILITY AND BETTER COSMETIC RESULTS

Celsite® Discreet offers unique design and allows better cosmetic results for the patient.

- The low profile design with patented 90° connection provides a high level of discretion
- Also available in small size to facilitate implantation in paediatric and underweight patients
- MR conditional, Latex, DEHP and PVC free
- With radiopaque CT marking.



Prevention of Port Flip

Patented 90° angle of the exit cannula reduces the risk of port flip and associated blockage due to catheter kinking

Better Cosmetic Results

The surgical incision can be made vertically and placed laterally following the subcutaneous traction lines

High pressure resistant

The complete range of venous Celsite® Epoxy ports is high pressure resistant up to 325 psi. This enables for power injections of contrast media in radiology, without the need for additional access and needlesticks.

Radiopaque CT Marking

Celsite® Epoxy offers radiopaque CT marking. With CT marking it is possible to identify the port as high pressure resistant in the x-ray image.

Catheter	Exit can- nula	OD (F/mm)	ID (mm)	Length (mm)	Flow rate* (ml/min)	325 PSI Recommended maximum flow rates (mL/s) Contrast media at 37°C (325 psi = 22.4 bar)**						Implantation technique	Type	Reference	Accesso- ries see page 30/31
						Viscosity 5.8 mPa.s (cP)			Viscosity 11.4 mPa.s (cP)						
						19 G	22 G	22 G	20 G	19 G	22 G				

Standard

Silicone	left	8.5/2.8	1.1	800	28	13	2	6	7	2	6	9	Seldinger	STL201L	04430144	1
Silicone	right	8.5/2.8	1.1	800	28	13	2	6	7	2	6	9	Seldinger	STR201L	04430145	1
PUR	left	8.5/2.8	1.6	800	45	12	2	6	8	2	7	9	Seldinger	STL201H	04440201	1
PUR	right	8.5/2.8	1.6	800	45	12	2	6	8	2	7	9	Seldinger	STR201H	04440202	1

Small

Silicone	left	6.5/2.2	1.1	800	24	10	2	5	8	2	5	6	Seldinger	STL205F	04430146	1
Silicone	right	6.5/2.2	1.1	800	24	10	2	5	8	2	5	6	Seldinger	STR205F	04430147	1
PUR	left	6.5/2.1	1.4	800	30	11	2	5	8	2	5	6	Seldinger	STL205P	04440203	1
PUR	right	6.5/2.1	1.4	800	30	11	2	5	8	2	5	6	Seldinger	STR205P	04440204	1

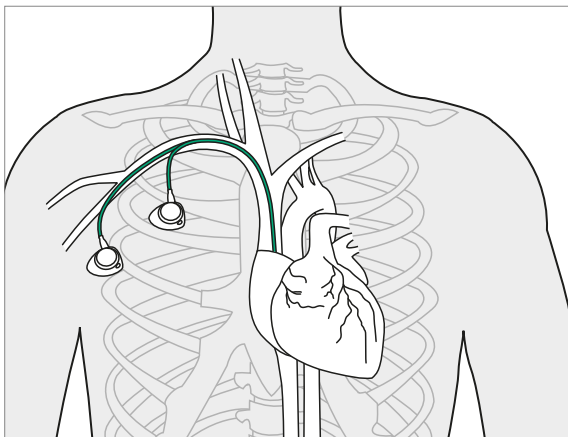

Standard and lateral placement of Celsite® Discreet with vertical incision.



CT-Marking of Celsite® Discreet

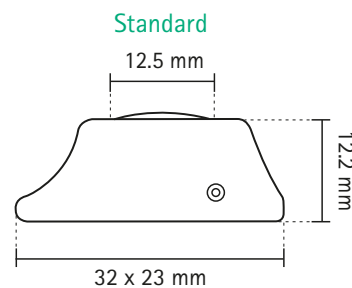

Material: Titanium | Epoxy
Weight: 7 g
Internal Volume: 0.5 mL

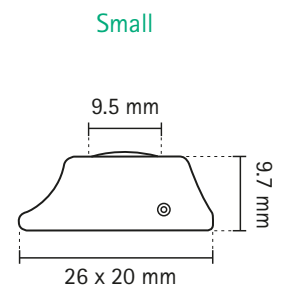

Material: Titanium | Epoxy
Weight: 4 g
Internal Volume: 0.25 mL

* Gravity flow rates established by gravity infusion of NaCl 0.9%, height 1m. Catheter length 40cm. According to ISO 10555-1.

** With a catheter of 20 cm and Surecan® Safety II. For countries under CE mark only.

Celsite® PSU

VENOUS ACCESS PORTS FOR MID TO LONG-TERM VENOUS APPLICATIONS

Celsite® PSU ports are the standard venous access port range for any condition that requires mid to long-term intermittent or continuous central venous infusions.

This might include chemotherapy, antibiotic and anti-viral drugs, parenteral nutrition, blood sampling or transfusion.

Celsite® PSU has a polysulphone body with a titanium chamber and is high pressure resistant up to 325 psi (22.4 bar).



- Anatomic design and lower profiled nose for simplified insertion and patient comfort
- Available in standard and small size
- 3 suture holes to facilitate fixation of the port
- Large range of silicone and polyurethane catheters
- The radiopaque catheter is graduated from 5 cm in order to facilitate an easy, precise and reliable implantation
- MRI-conditional, Latex, DEHP and PVC free
- Resistant to high pressure injection up to 325 PSI (22.4 bar)

Catheter	OD (F/mm)	ID (mm)	Length (mm)	Flow rate* (ml/min)		325 PSI Recommended maximum flow rates (mL/s) Contrast media at 37°C (325 psi = 22.4 bar)**									Implantation technique	Type	Reference	Accessories see page 30/31
						Viscosity 5.8 mPa.s (cP)			Viscosity 11.4 mPa.s (cP)									
						19G	22G	22G	20G	19G	22G	20G	19G					
Standard																		
PUR	5 /1.6	1.1	900	24	10	2	5	6	2	5	6	Seldinger	ST301C	04432096	2			
PUR	5 /1.6	1.1	370	24	10	2	5	6	2	5	6	OTW	ST301OTW	04433726	6			
PUR	6.5/2.1	1.4	800	34	11	2	5	7	2	5	6	Seldinger	ST301P	04430441	1			
PUR	6.5/2.1	1.4	800	34	11	2	5	7	2	5	6	Surgical cut-down	T301P	04430387	6			
Silicone	6.5/2.2	1.0	800	26	10	2	6	7	2	6	8	Seldinger	ST301F	04430433	1			
Silicone***	6.5/2.2	1.0	800	26	10	2	6	7	2	6	8	Seldinger	ST311F	04436717	1			
Silicone	6.5/2.2	1.0	800	26	10	2	6	7	2	6	8	Surgical cut-down	T301F	04430000	6			
Silicone	8.5/2.8	1.1	800	28	13	2	6	7	2	6	9	Seldinger	ST301	04430425	1			
Silicone***	8.5/2.8	1.1	800	28	13	2	6	7	2	6	9	Seldinger	ST311	04436709	1			
Silicone	8.5/2.8	1.1	800	28	13	2	6	7	2	6	9	Surgical cut-down	T301	04430018	6			
PUR (high flow)	8.5/2.8	1.6	800	45	12	2	6	8	2	7	9	Seldinger	ST301H	04432460	1			
PUR (high flow)	8.5/2.8	1.6	800	45	12	2	6	8	2	7	9	Surgical cut-down	T301H	04432452	6			
PUR (high flow)***	8.5/2.8	1.6	800	45	12	2	6	8	2	7	9	Seldinger	ST311H	04436814	1			
Silicone (high flow)	10 /3.2	1.6	800	47	13	2	6	9	2	6	8	Seldinger	ST301G	04433823	1			
Small																		
PUR	5 /1.6	1.1	900	22	10	2	5	7	2	5	6	Seldinger	ST305C	04436962	2			
PUR	6.5/2.1	1.4	800	30	11	2	5	8	2	5	6	Seldinger	ST305P	04436946	1			
Silicone	6.5/2.2	1.0	800	24	10	2	5	8	2	5	6	Seldinger	ST305	04433750	1			
Silicone***	6.5/2.2	1.0	800	24	10	2	5	8	2	5	6	Seldinger	ST315	04436725	1			
Silicone	6.5/2.2	1.0	800	24	10	2	5	8	2	5	6	Surgical cut-down	T305	04436903	6			
Silicone	8.5/2.8	1.1	800	25	10	2	5	8	2	5	7	Seldinger	ST305L	04436920	1			
Silicone***	8.5/2.8	1.1	800	25	10	2	5	8	2	5	7	Seldinger	ST315L	04436710	1			
PUR (high flow)	8.5/2.8	1.6	800	37	12	2	6	9	2	5	8	Seldinger	ST305H	04433556	1			

Celsite® PSU ports offer a wide range of silicone and PUR catheters combined with two different port sizes, Standard and Small.

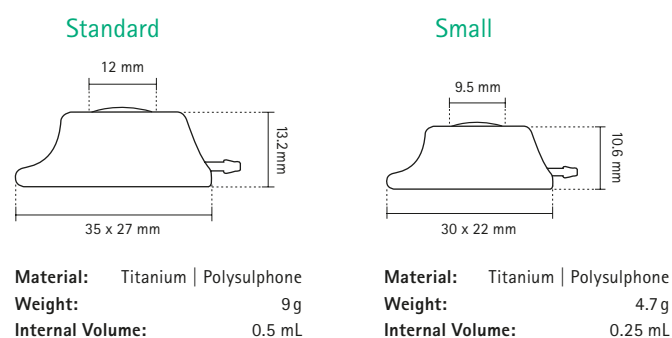

* Gravity flow rates established by gravity infusion of NaCl 0.9%, height 1m. Catheter length 40cm. According to ISO 10555-1.

** With a catheter of 20 cm and Surecan® Safety II. For countries under CE mark only.

*** With pre-connected catheters.

Celsite® IMPLANTOFIX®

VENOUS ACCESS PORTS WITH SCREW CLAMP CONNECTION

For repeated intra-venous administration of, for example, chemotherapy, antibiotics and anti-viral drugs, parenteral nutrition, blood sampling or transfusion.

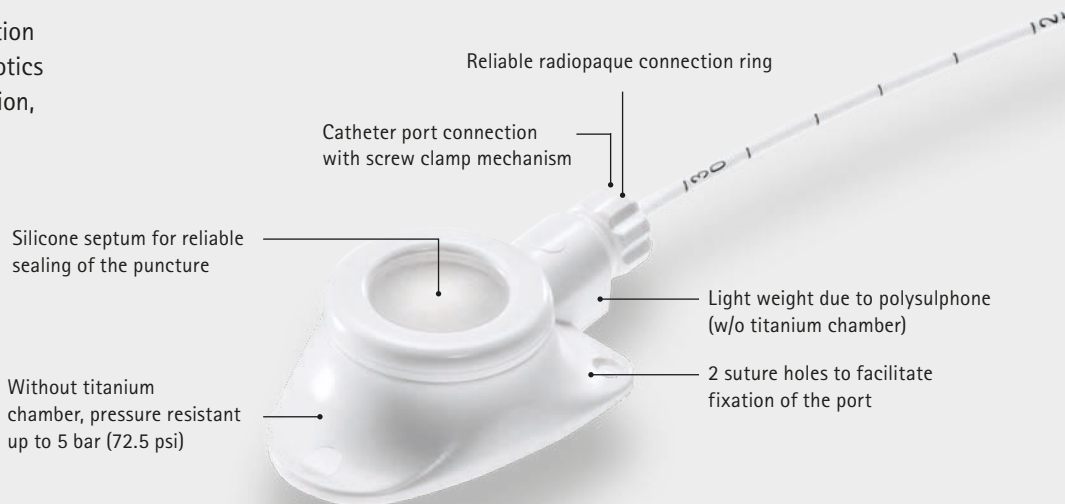

Catheter	OD (F/mm)	ID (mm)	Length (mm)	Flow rate* (ml/min)		Implantation technique	Type	Reference	Accessories see page 30/31
				19G	22G				
Standard									
PUR	5 / 1.6	1.1	700	22	10	Surgical cut-down	IMPLANTOFIX®	04430263	6
PUR	5 / 1.6	1.1	370	22	10	Seldinger, OTW	IMPLANTOFIX®	04438604	13
Silicone	6 / 2.0	1.2	600	26	11	Seldinger	IMPLANTOFIX® S	04438704	13
Small									
PUR	5 / 1.6	1.1	370	22	10	Seldinger, OTW	IMPLANTOFIX®	04438647	13
Silicone	6 / 2.0	1.2	600	26	11	Seldinger	IMPLANTOFIX® S	04438747	12

All IMPLANTOFIX® products contain:

- 2x Screw connectors
- 2x Straight Surecan® 22G x 30 mm
- 1x Spanner
- 1x Vein lifter

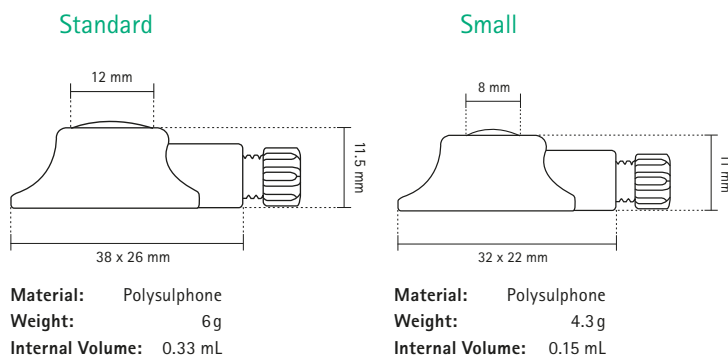

* Gravity flow rates established by gravity infusion of NaCl 0.9%, height 1m. Catheter length 40cm. According to ISO 10555-1.

Celsite® Double

SPECIALIZED VENOUS ACCESS PORTS WITH TWO SEPARATE PORT CHAMBERS FOR SIMULTANEOUS INFUSION

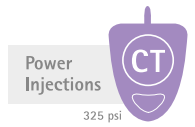

- For simultaneous infusion of e.g. incompatible drugs
- For infusion with high flow rates by using both lumina
- Administration of continuous infusion and bolus injection
- Alternating puncture sites
- Profiled shape to be easily placed in a small pocket
- Small size facilitates implantation in paediatric and underweight patients
- Off-set silicone catheter tip ensures that no mixing of drugs occurs at the catheter tip
- With radiopaque CT marking.



Catheter	OD (F/mm)	ID (mm)	Length (mm)	Flow rate* (ml/min)		325 PSI Recommended maximum flow rates (mL/s) Contrast media at 37°C (325 psi = 22.4 bar)						Implantation technique	Type	Reference	Accessories see page 30/31	
						Viscosity 5.8 mPa.s (cP)			Viscosity 11.4 mPa.s (cP)							
						19 G	22 G	22 G	20 G	19 G	22 G					20 G
Standard																
Silicone	10 / 3.2	1.2 x 2	800	32	11	2	5	8	2	6	9	Seldinger	ST401L	04430100	1	
Small																
Silicone	10 / 3.2	1.2 x 2	800	29	11	2	5	8	2	5	7	Seldinger	ST405L	04430101	1	

Standard

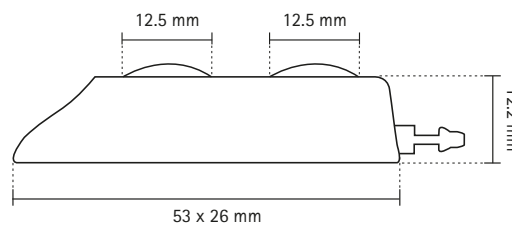

Material: Titanium | Epoxy
Weight: 14g
Internal Volume: 0.5 mL x 2

Small

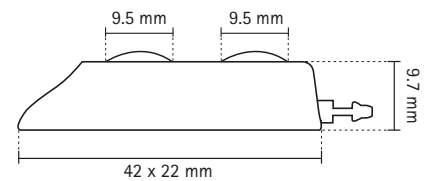

Material: Titanium | Epoxy
Weight: 7.5g
Internal Volume: 0.25 mL x 2

* Gravity flow rates established by gravity infusion of NaCl 0.9%, height 1m. Catheter length 40cm. According to ISO 10555-1.

** With a catheter of 20 cm and Surecan® Safety II. For countries under CE mark only.

Celsite® Valved

VENOUS PSU ACCESS PORTS WITH VALVED CATHETER TIP

- For chemotherapy, administration of antibiotics, parenteral nutrition and blood sampling
- Allows easy infusion and aspiration
- Anti-Reflux radiopaque silicone catheter
- Distal 3-way valve

Conditions:

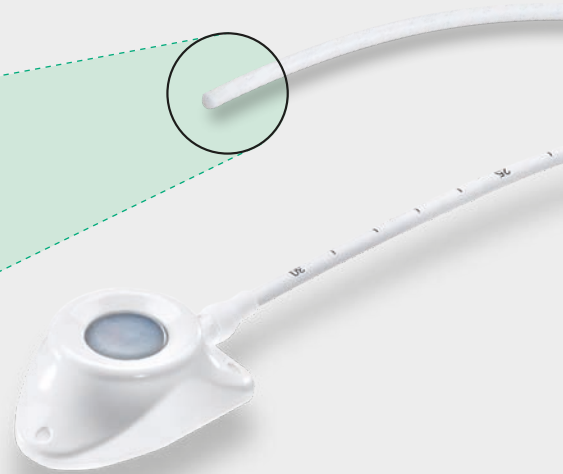

Catheter	OD (F/mm)	ID (mm)	Length (mm)	Flow rate* (ml/min)		Implantation technique	Type	Reference	Accessories see page 30/31
				19G	22G				
Standard									
Silicone	7.5 / 2.5	1.5	800	30	11	Seldinger	ST301V	04430092	1
Small									
Silicone	7.5 / 2.5	1.5	800	27	10	Seldinger	ST305V	04430095	1

Standard

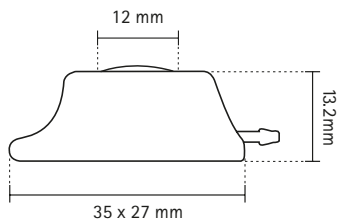

Material: Titanium | Polysulphone
Weight: 9g
Internal Volume: 0.5 mL

Small

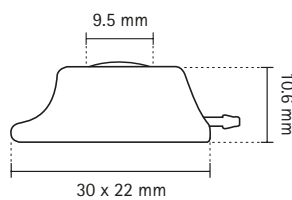

Material: Titanium | Polysulphone
Weight: 4.7g
Internal Volume: 0.25 mL

* Gravity flow rates established by gravity infusion of NaCl 0.9%, height 1m. Catheter length 40cm. According to ISO 10555-1.

Celsite® Arterial

FOR HEPATIC ARTERY INFUSION THERAPY (SURGICAL IMPLANTATION TECHNIQUE)

- For loco-regional chemotherapy of liver tumours and hepatic artery infusion therapies
- The access port is implanted at the base of the ribs, while the catheter is introduced into the *arteria gastroduodenalis* so that the catheter tip is located in the *arteria hepatica*
- The radiopaque silicone catheter has two rings to facilitate immobilisation of the catheter in the artery

Accessories:

Every Access Port kit contains

- 2 Straight Surecan® needles 22G x 30 mm
- 1 vein lifter



Catheter	Access Port	OD (F/mm)	ID (mm)	Length (mm)	Flow rate* (ml/min)		Implantation technique	Type	Reference
					19G	22G			
Standard									
Silicone	Celsite® (Titanium/ Polysulphone)	6.5 / 2.2	1.0	800	26	10	Surgical cut-down	T302	04430042
PUR	IMPLANTOFIX® (Polysulphone)	5 / 1.7	1.1	700	22	10	Surgical cut-down	IMPLANTOFIX®	04438817**

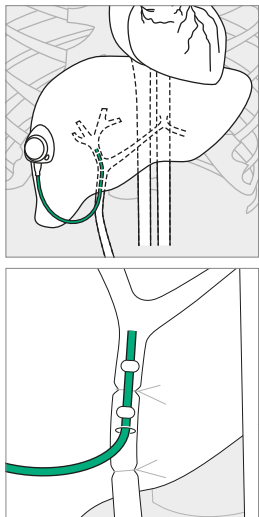

Celsite® Standard

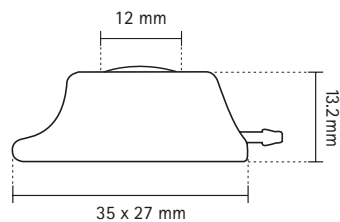

Material: Titanium | Polysulphone
Weight: 9 g
Internal Volume: 0.5 mL

Celsite® IMPLANTOFIX® Standard

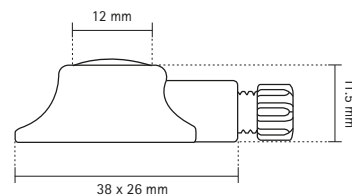

Material: Polysulfon
Weight: 6 g
Internal Volume: 0.33 mL

* Gravity flow rates established by gravity infusion of NaCl 0.9%, height 1m. Catheter length 40cm. According to ISO 10555-1.

** Polyurethane catheter with two rings.

Celsite® Peritoneal

FOR LOCO-REGIONAL CHEMOTHERAPY OF PERITONEAL METASTASES AND OVARIAN CANCER

- For loco-regional chemotherapy of peritoneal metastases and ovarian cancer
- The access port is implanted at the base of the ribs and the catheter is placed at the required location inside the abdominal cavity
- The radiopaque silicone catheter with multiple perforations enables enhanced diffusion of infused drugs and reliable patency of the catheter



Catheter	OD (F/mm)	ID (mm)	Length (mm)	Flow rate* (ml/min)		Implantation technique	Type	Reference
				19G	22G			
Standard								
Silicone	15 / 4.9	2.6	420	55	13	peritoneal	T203J	04430069

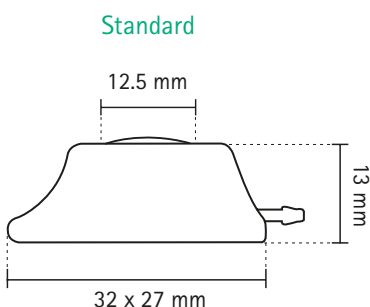

Material: Titanium | Epoxy
Weight: 10g
Internal Volume: 0.5 mL

Accessories:

Every Access Port kit contains

- 2 Straight Surecan® needles 22G x 30 mm
- 1 vein lifter

The implantation accessories kit AP16F can be ordered separately (Reference 4430493; see page 31).

* Gravity flow rates established by gravity infusion of NaCl 0.9%, height 1m. Catheter length 40cm. According to ISO 10555-1.

Celsite® DRAINAPORT

FOR INTRA-PERITONEAL ADMINISTRATION OF CHEMOTHERAPY, DRAINAGE OF MALIGNANT ASCITES, OR DRAINAGE OF MALIGNANT PLEURAL EFFUSION

- For intra-peritoneal administration of chemotherapy, hydration, drainage of malignant ascites, or drainage of malignant pleural effusion
- Helps to avoid repeated, painful puncture for drainage
- Improves quality of life and is an easy and effective solution for home care treatment
- Celsite® DRAINAPORT can be implanted percutaneously or by surgical cut-down technique
- **Catheter cuff** promotes tissue ingrowth to reduce infection risk and holds the catheter in place

- **Connection** is enabled by the radiopaque titanium connection ring
- **Silicone septum** for reliable puncture
- **Anatomic design** with delta shape profile, light weight and easy to suture
- Smooth, large and flexible **multiperforated silicone catheter** with 49 oval holes (Ø 1.1 x 1.6 mm) from the tip up to 20 cm to prevent blockage of the catheter and enhance efficiency



Catheter	OD (F/mm)	ID (mm)	Length (mm)	Flow rate* (ml/min)		Implantation technique	Type	Reference
				19G	22G			
Standard								
Silicone	15/4.9	2.6	550	55	13	peritoneal / pleural	T203J-1	04430169

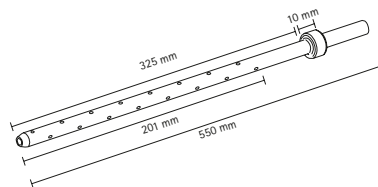
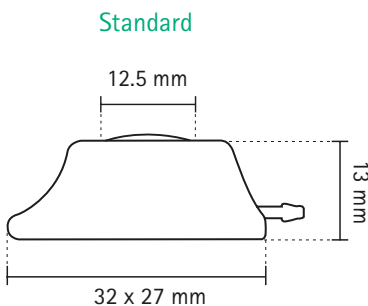

Material: Titanium | Epoxy
Weight: 10g
Internal Volume: 0.5 mL

Accessories:

Every Access Port kit contains

- 2 Straight Surecan® needles 22G x 30 mm

The implantation accessories kit AP16F can be ordered separately (Reference 4430493; see page 31).

B. Braun Drainage Kit is separately available.

It contains:

- 1 Pleuracan® double anti-reflux valve
- 1 Secretion bag 2.0l
- 1 Combifix® male/male Adapter

Reference: 5021571

* Gravity flow rates established by gravity infusion of NaCl 0.9%, height 1m. Catheter length 40cm. According to ISO 10555-1.

Celsite® Spinal

FOR SPINAL ADMINISTRATION OF PAIN RELIEVING DRUGS

- For spinal and epidural administration of pain relieving drugs
- The catheter is tunneled under the skin to the access port, which is implanted at the base of the ribs
- Light weight and comfortable
- Profiled shape design facilitates insertion
- Integrated 20 µm titanium filter prevents the passage of particles

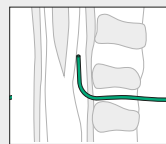
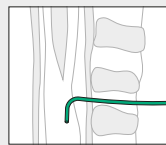
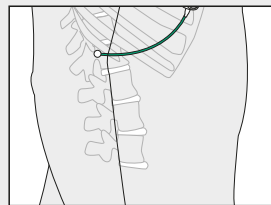

Catheter	OD	OD (mm)	ID (mm)	Length (mm)	Flow rate* (ml/min)		Implantation technique	Type	Reference
					19G	22G			
Standard									
PUR and PA	19G	1.05	0.6	1000	3	3	spinal/epidural	ST304-19	04430096
PUR and PA	20G	0.86	0.45	1000	1	1	spinal/epidural	ST304-20	04430097

Catheter

Every Access Port kit contains 2 catheters:

- 1 multiperforated closed tip polyamide catheter (PA)
- 1 open tip polyurethane catheter (PUR) with a teflon-coated guide wire

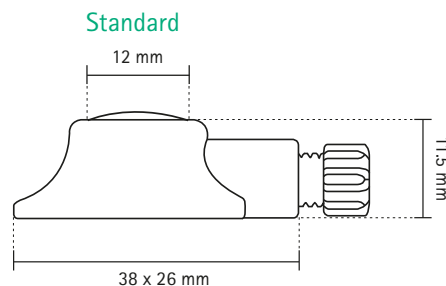

Material: Polysulphone | Titanium-Filter
Weight: 6g
Internal Volume: 0.33 mL

Accessory kit:

- Screw connector (2x)
- Spanner
- Anti-kink device (2x)
- Tunneling rod
- Winged Surecan® needle 20G x 20 mm
- Omnifix® syringe 10 mL
- Perican Tuohy needle 16G (ST304-19) or Tuohy needle 18G (ST304-20)
- Perifix 0.2 µm filter
- Scalpel size 10 and 11
- Sterican™ needle 20G x 70 mm
- Perifix® LOR syringe
- Straight Surecan® 22G x 30 mm (2x)

* Gravity flow rates established by gravity infusion of NaCl 0.9%, height 1m. Catheter length 40cm. According to ISO 10555-1..

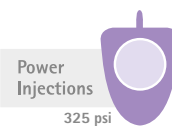

MR-Conditional Celsite® Access Ports

Non-clinical testing demonstrated that Celsite® Access Ports are MR Conditional. A patient with these devices can be scanned immediately after placement under the following conditions:

- Static magnetic field of 3-Tesla and 1.5-Tesla
- Maximum spatial gradient magnetic field of 4000 (extrapolated) Gauss/cm or less
- Maximum whole body averaged specific absorption rate (SAR) of 2 W/kg for 15 minutes of scanning (i.e., per pulse sequence) in the normal operating mode of operation for the MR system.

MR-Conditional Surecan® and Cytocan® port needles

Non-clinical testing demonstrated that Surecan®/Cytocan® port needles are MR Conditional. A patient with these devices can be scanned immediately after placement under the following conditions:

- Static magnetic field of 3-Tesla and 1.5-Tesla
- Maximum spatial gradient magnetic field of 710 Gauss/cm or less
- Maximum whole body averaged specific absorption rate (SAR) of 2.9 W/kg for 15 minutes of scanning

MR image quality may be compromised if the area of interest is in the exact same area or relatively close to the position of the devices. Therefore, optimization of MR imaging parameters to compensate for the presence of these devices may be necessary.

Please see instructions for use for general information and information on MRI-related heating.

Pressure Resistance

All venous Celsite® Access Ports with titanium chamber or a titanium plate are resistant to high pressure injection up to 325 psi / 22.4 bar (except for valved catheters and Celsite® Implantofix®).

Please see instructions for use for detailed device information regarding high pressure injection.

Material

All Celsite® Access Ports are latex-, PVC- and DEHP-free. All Surecan®/Cytocan® needles are latex- and DEHP-free.

LATEX
FREE

PVC
FREE

DEHP
FREE

Surecan® Safety II

HIGH PRESSURE RESISTANT NON-CORING SAFETY NEEDLE FOR ACCESS PORTS

Surecan® Safety II is the power injectable access port needle with an easy to use safety mechanism for reduced risk of needlestick injuries.

The small size and innovative design of Surecan® Safety II enables comfort for both clinicians and patients, either in hospital or for home care treatment.



User safety

Intuitive safety mechanism for reduced risk of needlestick injuries

Patient comfort

Low profile and foam pad for better patient comfort

Handling

Flexible and ergonomic wings for reliable handling

Power injections

Suitable for power injections up to 325 psi

Easy removal

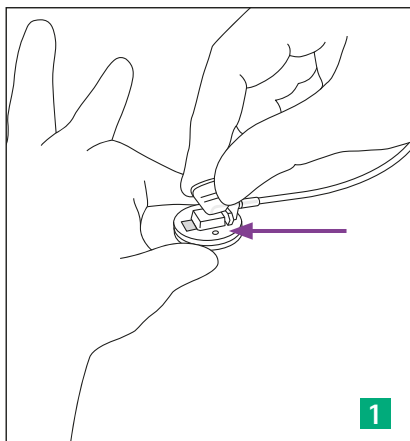

Stabilise the needle base on the port

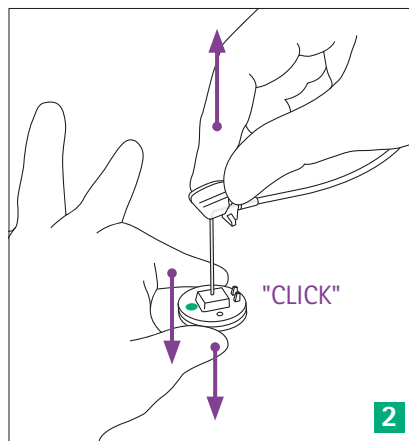

Firmly pull the wings up until you hear a "Click"

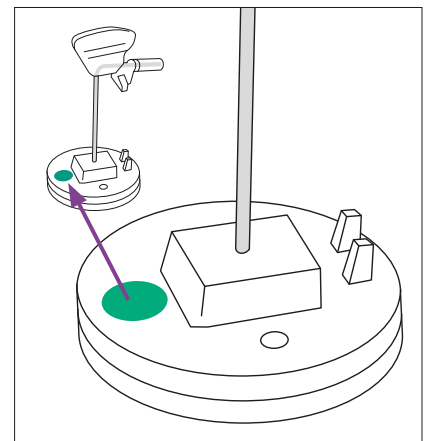

Green dot and audible click clearly indicate the safety mechanism was executed

Surecan® Safety II

HIGH PRESSURE RESISTANT NON-CORING SAFETY NEEDLE FOR ACCESS PORTS

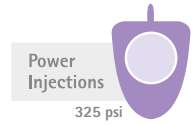

Surecan® Safety II non-coring safety needle

- tubing length cannula to connector: 200 mm



Size	Cannula diameter (mm)	Cannula length (mm)	Sales unit (pcs.)	Reference
G 19	1.1	12	20	04447042
G 19	1.1	15	20	04447000
G 19	1.1	20	20	04447001
G 19	1.1	25	20	04447002
G 19	1.1	32	20	04447003
G 19	1.1	38	20	04447004
G 20	0.9	12	20	04447043
G 20	0.9	15	20	04447005
G 20	0.9	20	20	04447006
G 20	0.9	25	20	04447007
G 20	0.9	32	20	04447008
G 20	0.9	38	20	04447009
G 22	0.7	12	20	04447044
G 22	0.7	15	20	04447010
G 22	0.7	20	20	04447011
G 22	0.7	25	20	04447012
G 22	0.7	32	20	04447013

Surecan® Safety II non-coring safety needle with pre-connected Caresite® and Y-site

- Y-site configuration
- tubing length Y-site to connector: 98 mm
- tubing length cannula to Y-site: 105 mm
- Caresite® is a needle-free, positive pressure valve which reduces the risk of blood reflux



Size	Cannula diameter (mm)	Cannula length (mm)	Sales unit (pcs.)	Reference
G 19	1.1	12	20	04447057
G 19	1.1	15	20	04447045
G 19	1.1	20	20	04447046
G 19	1.1	25	20	04447047
G 19	1.1	32	20	04447048
G 19	1.1	38	20	04447049
G 20	0.9	12	20	04447058
G 20	0.9	15	20	04447050
G 20	0.9	20	20	04447051
G 20	0.9	25	20	04447052
G 20	0.9	32	20	04447053
G 22	0.7	12	20	04447059
G 22	0.7	15	20	04447054
G 22	0.7	20	20	04447055
G 22	0.7	25	20	04447056

- Non-absorbant closed-cell foam pad of the patient plate
- MR conditional, Latex and DEHP free

LATEX
FREE

DEHP
FREE

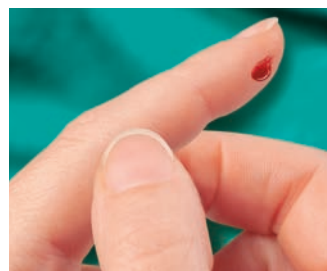

For more information on the risks and prevention of needlestick injuries:

www.safeinfusiontherapy.com

Winged Surecan® | Cytocan®

ACCESS PORT NEEDLES

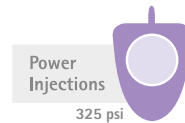

Winged Surecan® non-coring needle

- use for long-term infusions
- high pressure resistant up to 325 psi (22.4 bar)
- flexible wings for easier puncture and fixation
- latex- and DEHP-free
- extension tubing with clamp
- tubing length cannula to connector: 200 mm



Size	Cannula diameter (mm)	Cannula length (mm)	Sales unit-pcs.	Reference
19G	1.1	15	15	04448286
19G	1.1	20	15	04448294
19G	1.1	25	15	04448308
20G	0.9	15	15	04448332
20G	0.9	20	15	04448340
20G	0.9	25	15	04448359
20G	0.9	30	15	04448367
22G	0.7	12	15	04448375
22G	0.7	15	15	04448383
22G	0.7	20	15	04448391
22G	0.7	25	15	04448405

Winged Surecan® non-coring needle with Y-site

- use for long-term infusions
- flexible wings for easier puncture and fixation
- latex- and DEHP-free
- tubing length Y-site to connector: 98 mm
- tubing length cannula to Y-site: 105 mm
- Y-site configuration



Size	Cannula diameter (mm)	Cannula length (mm)	Sales unit-pcs.	Reference
19G	1.1	20	15	04448430
19G	1.1	25	15	04448448
20G	0.9	15	15	04448472
20G	0.9	20	15	04448480
20G	0.9	25	15	04448499
22G	0.7	15	15	04448529
22G	0.7	20	15	04448537
22G	0.7	25	15	04448545
22G	0.7	30	15	04448553

Cytocan® non-coring needle with fixation base

- use for long-term infusions
- flexible, transparent fixation base for reliable deployment
- latex-, PVC- and DEHP-free
- extension tubing with clamp
- tubing length cannula to connector: 250 mm



Size	Cannula diameter (mm)	Cannula length (mm)	Sales unit-pcs.	Reference
19G	1.1	15	25	4438035
19G	1.1	20	25	4438019
19G	1.1	25	25	4438027
20G	0.9	15	25	4439759
20G	0.9	20	25	4439767
20G	0.9	25	25	4439775
22G	0.7	15	25	4439694
22G	0.7	20	25	4439635
22G	0.7	25	25	4439686

Angled Surecan® | Straight Surecan®

ACCESS PORT NEEDLES

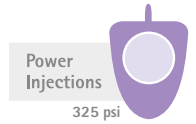

Angled Surecan® non-coring needle

- use for short-term infusions
- latex-, PVC- and DEHP-free



Size	Cannula diameter (mm)	Cannula length (mm)	Sales unit-pcs.	Reference
19G	1.1	15	50	04438000
19G	1.1	20	50	04439430
19G	1.1	25	50	04439406
20G	0.9	15	50	04439929
20G	0.9	20	50	04439937
20G	0.9	25	50	04439945
20G	0.9	35	50	04434862
22G	0.7	15	50	04439813
22G	0.7	20	50	04439821
22G	0.7	25	50	04439830
22G	0.7	35	50	04434870

Straight Surecan® non-coring needle

- use for bolus injection or flushing of the Access Port
- latex-, PVC- and DEHP-free



Size	Cannula diameter (mm)	Cannula length (mm)	Sales unit-pcs.	Reference
20G	0.9	40	100	04439953
20G	0.9	70	100	04439998
20G	0.9	90	100	04440000
22G	0.7	30	100	04439848
24 G	0.55	25	100	04439414

Celsite® Access Port Systems

RECOMMENDED MAXIMUM FLOW RATES (ML/S)

with Surecan® Safety II, Angled Surecan® needle and Winged Surecan® needle without Y-site (except Celsite® Safety)



Recommended maximum flow rates (mL / s) with a catheter of 20 cm and contrast media at 37° C (98.6 F)

		Viscosity 5,8 mPa.s (cP)** (4)			Viscosity 11,4 mPa.s (cP)** (5)		
		Winged / Angled Surecan® needle (7) / Surecan® Safety II			Winged / Angled Surecan® needle (7) / Surecan® Safety II		
		22 G	20 G	19 G	22 G	20 G	19 G
Baby Size Port	Babyport®	2	4	-	2	3	-
	Brachial	2	5	-	2	4	-
	Babyport® S	2	5	-	2	5	-
Double port (9)	ST405L	2	5	8	2	5	7
	ST401L	2	5	8	2	6	9
Small Size Port (10)	ST305C	2	5	7	2	5	6
	STL205P - STR205P - ST305P - ST205P - BT305P	2	5	8	2	5	6
	T/ST305 - T/ST205 - SNT305F - ST315 - ST215-T/ST205F ECG - SNT215F - STL205F - STR205F	2	5	8	2	5	6
	ST305L - T/ST205ECG - ST205L - ST315L	2	5	8	2	5	7
	ST305H - ST205H	2	6	9	2	5	8
Standard Size Port (11)	ST301C - ST201C - ST301OTW	2	5	6	2	5	6
	T/ST301P - ST201P - BT301P	2	5	7	2	5	6
	T/ST201F - T/ST201F ECG - SNT201F - T/ST301F - ST311F - SNT301F	2	6	7	2	6	8
	T/ST201 - T/ST201ECG - T/ST301-ST311 - STL201L - STR201L	2	6	7	2	6	9
	ST201H - T/ST301H - ST311H - STL201H - STR201H	2	6	8	2	7	9
	ST301G - ST201G	2	6	9	2	6	8

Recommended maximum pressure (CT function) - 325 psi (22.4 bar)

Flow rates may vary depending on temperature of contrast media and length of the implanted catheter.

Flow rates established with a catheter of 20 cm.

Celsite® Access Port Systems

PORTFOLIO OVERVIEW AND TYPE DECLARATION

Indication	Catheter	OD	Catheter material	Access Port type	Dead volume port	Dead volume catheter (mL/cm)		
Venous	Small catheters	5 F	Polyurethane	ST201C	0.50 mL	0.010 mL		
				ST301C, ST301OTW	0.25 mL			
				ST305C				
				4430263, 4438604				
				4438647				
				SST605C			0.30 mL	
	6.5 F	Polyurethane	ST201P, T301P, ST301P	0.50 mL	0.015 mL			
			ST305P, STL205P, STR205P	0.25 mL				
			T601P, SST601P	0.50 mL				
	6 F	Silicone	SST605P	0.30 mL	0.011 mL			
			4438704 (Implantofix®)	0.33 mL				
	6.5 F	Silicone	4438747 (Implantofix®)	0.15 mL	0.008 mL			
			T201F, ST201F, T301F, ST301F, ST311F*, ST201F ECG	0.50 mL				
			T205, ST205, ST215*, T305, ST305, ST315*	0.25 mL				
			T601F, SST601F	0.50 mL				
			T605F, SST605F	0.30 mL				
			T201, ST201, T301, ST301, ST311*, STL201L, STR201L	0.50 mL				
	Large and high flow catheters	8.5 F	Silicone	ST305L	0.25 mL	0.010 mL		
T601L, SST601L				0.5 mL				
SST605L				0.3 mL				
8.5 F		Polyurethane	ST201H, T301H, ST301H, ST311H*, STL201H, STR201H	0.50 mL	0.020 mL			
			ST305H	0.25 mL				
			T601H, SST601H	0.50 mL				
10 F	Silicone	SST605H	0.3 mL	0.020 mL				
		ST201G, ST301G	0.50 mL					
Speciality venous	Small catheters	4.5 F	Polyurethane	Babyport®	0.15 mL	0.005 mL		
				5 F	Polyurethane	Brachial	0.15 mL	0.010 mL
				6 F	Silicone	Babyport® S	0.15 mL	0.011 mL
				6.5 F	Silicone	STR205F, STL205F, ST205F ECG	0.25 mL	0.008 mL
	Large and high flow catheters	8.5 F	Silicone	STR201L, STL201L, ST201 ECG	0.50 mL	0.010 mL		
				ST205ECG	0.25 mL			
	Valved catheters	7.5 F	Silicone	ST301V	0.50 mL	0.018 mL		
				ST305V	0.25 mL			
Double port catheters	10 F	Silicone	ST401L	0.50 mL x 2	0.013 mL			
			ST405L	0.25 mL x 2				
Other specialities	Small arterial catheters	5 F	Polyurethane	4438817	0.33 mL	0.010 mL		
		6.5 F	Silicone	T302	0.50 mL	0.008 mL		
	Peritoneal catheters	15 F	Silicone	T203J, T203J-1	0.50 mL	0.053 mL		
		19 G	Polyamide and polyurethane	ST304-19	0.33 mL	0.003 mL		
20 G	Polyurethane	ST304-20	0.33 mL	0.002 mL				

* Pre-connected Access Port Systems

Type Declaration:

Accessories	Exit Cannula Orientation	Housing Material / Suture Holes	Connection	Indication	Catheter	Technique
SST = Safety Seldinger Equipment ST = Seldinger Equipment T = Surgical Cut-Down	R = right cannula exit L = left cannula exit	2 = Epoxy housing 3 = PSU housing w. empty suture holes 4 = Epoxy Double housing 5 = PSU housing w. Silicone suture areas 6 = PEEK housing w. suture holes 7 = PEEK housing with silicone plugs	0 = w. separate connection rings 1 = pre connected	1= Venous (std) 2= Arterial 3= Peritoneal & pleural 4= Spinal 5= Venous (small)	C = PUR; 5F F = Si; 6.5F L = Si; 8.5F P = PUR; 6.5F H = PUR; 8.5F G = Si; 10F V = Si Valved; 7.5F	OTW = Over the Wire ECG = ECG implantation technique

Accessories

Venous accessories

Pieces	Kit designation	Implantation technique	Percutaneous				
			Seldinger		OTW		
			Kit 1	Kit 12	Kit 3	Kit 13	
2	A	Straight Surecan® needles	22 G x 30 mm	22 G x 30 mm	22 G x 30 mm	22 G x 30 mm	22 G x 30 mm
1	B	Vein lifter	x	x	x	x	x
1	C	Puncture needle	18 G x 70 mm	18 G x 70 mm	18 G x 70 mm	18 G x 70 mm	18 G x 70 mm
1	E	J guide wire with dispenser	0.035" x 50 cm	0.035" x 50 cm	0.035" x 70 cm	0.035" x 70 cm	0.035" x 50 cm
1	F	Dilator			6F x 100 mm	6F x 100 mm	
1	G	Tear-away introducer	L 180/140 mm	L 180/140 mm			L 180/140 mm
1	H	Tunnelling rod	x	x	x	x	x
1	I	Omnifix luer syringe	10 mL	10 mL	10 mL	10 mL	10 mL
1	J	Winged Surecan® needle	20 G x 20 mm		20 G x 20 mm		20 G x 20 mm

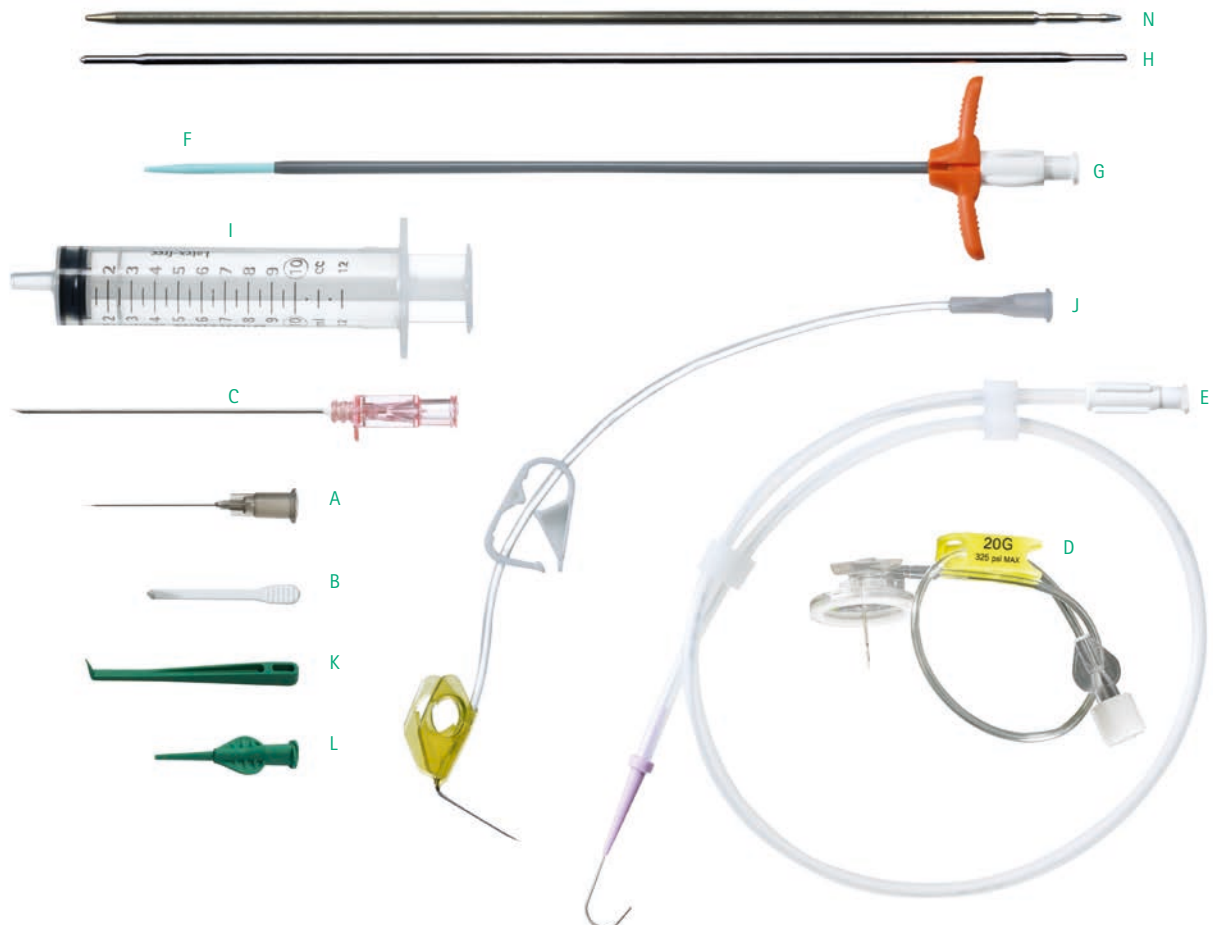

Accessories

Venous accessories

		Implantation technique	Surgical Cut-down		Percutaneous			
				ECG	OTW	Seldinger		ECG
Pieces		Kit designation	Kit 6	Kit 14	Kit 10 (Brachial)	Kit 4 (Baby)	Kit 5 (Baby)	Kit 9
2	A	Straight Surecan® needles	22 G x 30 mm	22 G x 30 mm	22 G x 30 mm	22 G x 30 mm	22 G x 30 mm	22 G x 30 mm
1	B	Vein lifter	x	x	x	x	x	x
1	C	Puncture needle			18 G x 70 mm	20 G x 50 mm	18 G x 70 mm	18 G x 70 mm
1		Introcan needle				20 G x 32 mm		
1	E	J guide wire with dispenser		0.035" x 70 cm	0.035" x 150 cm	0.025" x 50 cm	0.035" x 50 cm	0.035" x 70 cm
1	F	ECG cable		x				x
1	G	Tear-away introducer/ Dilator			L 180/140 mm	L 80/50 mm	L 180/140 mm	180/140 mm
1	H	Tunnelling rod			x	x	x	x
1	I	Omnifix luer syringe		10 mL	10 mL	10 mL	10 mL	10 mL
1	J	Winged Surecan® needle			22 G x 15 mm	22 G x 15 mm	22 G x 15 mm	20 G x 20 mm

Separate accessory kits

		Reference	04430483	04430484	04430492	04430493
Pieces		Kit designation	AP 6F	AP 7F	AP 9F	AP 16F
1	C	Puncture needle	20 G x 50 mm	18 G x 70 mm	18 G x 70 mm	18 G x 70 mm
1		Introcan needle	20 G x 32 mm			
1	E	J guide wire with dispenser	0.025" x 50 cm	0.035" x 50 cm	0.035" x 50 cm	0.035" x 40 cm
1	G	Tear-away introducer/ Dilator	6F, short (80/50 mm)	7F x180/140 mm	9F x180/140 mm	16F with dilator 12F-14F
1	H	Tunnelling rod	x	x	x	x
1	B	Vein lifter	x	x	x	
1	I	Omnifix luer syringe	10 mL	10 mL	10 mL	10 mL
1	J	Winged Surecan® needle	22 G x 15 mm	20 G x 20 mm	20 G x 20 mm	19 G x 25 mm

Accessories

Celsite® Safety accessory kits

	Implantation technique	Seldinger	Surgical cut-down	Seldinger (SNT)
	Kit Designation	Kit 7	Kit 8	Kit 11
A	Tunnelling Rod	✓	-	✓
B	Tear-away Introducer	L 180/140 mm	-	L 180/140 mm
C	Omnifix® Luer Syringe	10 mL	-	10 mL
D	Straight Surecan®	22 G x 30 mm	22 G x 30 mm	22 G x 30 mm
E	Vein Lifter	✓	✓	✓
F	Rinsing Hub	✓	✓	✓
G	Safecan™ Safety - Puncture Needle	18 G x 70 mm	-	18 G x 70 mm
H	Surecan® Safety II	20 G x 20 mm	-	-
I	J Guide Wire with Dispenser	0.035" x 50 cm	-	0.035" x 50 cm
J	Ultrasound Cover	-	-	1 US Probe (127 x 1473,2 mm), 1 Gel, 2 Orange Fixation Rings, Pouch

ACCESSORIES

- A** Tunneling rod for easy catheter tunneling
- B** Peelable introducer sheath with dilatator for easy percutaneous access
- C** Omnifix® Luer Syringe
- D** 1 Surecan® Straight for flushing, aspiration and local anesthesia
- E** Long vein lifter allows easy handling
- F** Separate Rinsing Hub for more flushing flexibility during implantation
- G** Safecan™ Safety - Safety Echogenic Vein Puncture Needle
- H** Surecan® Safety II - Safety Port Needle
- I** Stainless Steel guidewire with flexible J-tip
- J** Ultrasound Cover

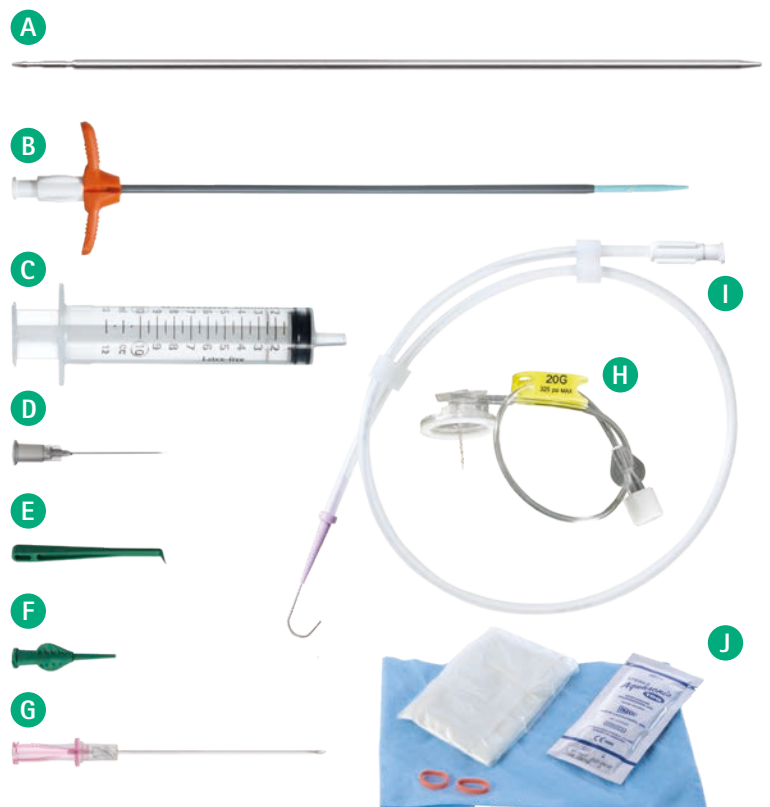

Customized Access Port Kits

INDIVIDUAL COMPLETE SOLUTION FOR PORT IMPLANTATIONS



Customized Access Port Kits – Combination of a sterile Access Port & individual components in one pouch for standardized procedures.

All components in one pouch means:

- Simplifying and shortening the preparation time for a more efficient port implantation*
- Reducing packaging waste in the hospital and facilitating the storage
- Safety components designed to minimize the risk of needle stick injuries according to the EU directive 2010/32/EC
- B. Braun's well known experience and quality as kit provider for customized solutions

ANALYSE PROCESSES –
FINDING SOLUTIONS

* Data on file at B. Braun

Standard Access Port Kits

THE CELSITE®, SURECAN® AND SAFECAN™ FAMILY

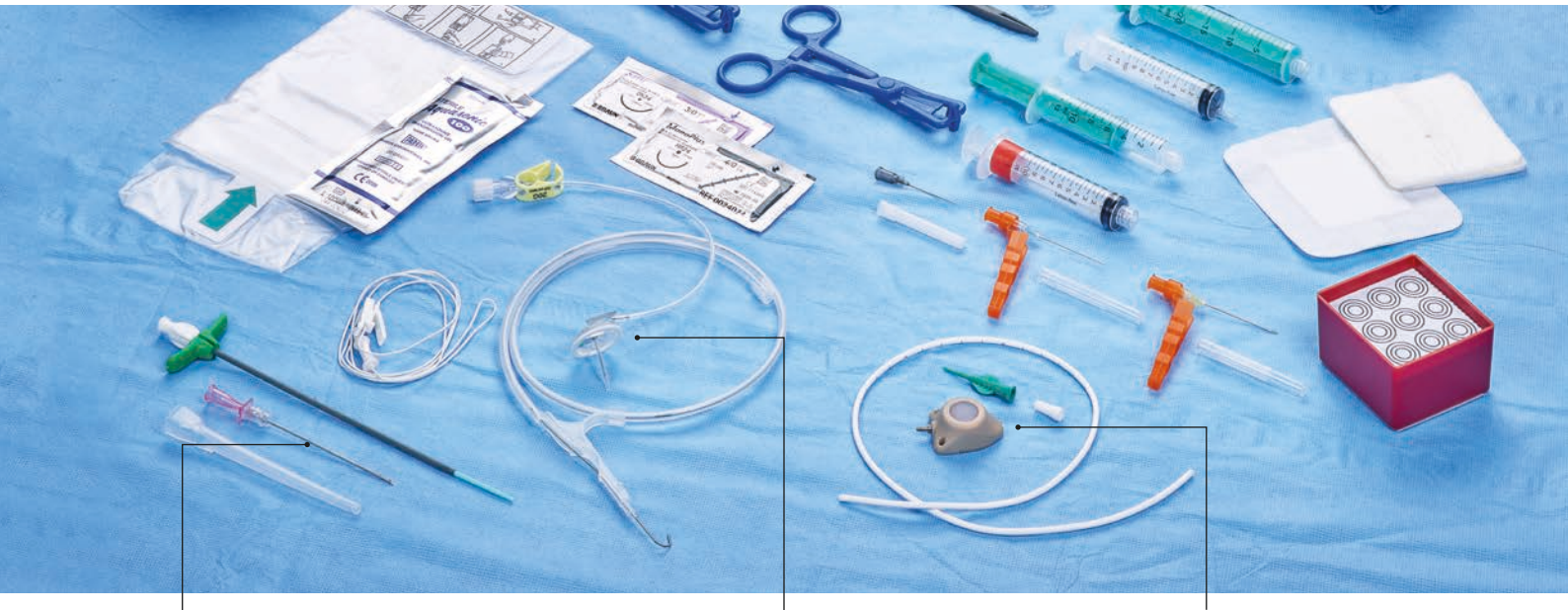

Safecan™ Safety - Safety Puncture Needle

- Safety mechanism to reduce the risk of needle stick injuries
- Echogenic puncture needle for needle tip location via ultrasound



Surecan® Safety II - Safety Port Needle

- Intuitive safety mechanism to reduce the risk of needle stick injuries
- High pressure resistance up to 325 psi



CelSITE® Safety - Venous Access Ports without any compromise on safety

- PEEK material (Polyetheretherketone) for high chemical resistance and excellent durability
- Extra large septum diameter for easy puncturing
- Titanium bottom plate for high puncture resistance
- Anatomic design with a low profiled nose simplifies the insertion and allows the creation of a small port pocket

IN COMPLIANCE WITH EU DIRECTIVE 2010/32/EC

Standard Access Port Kits

TOTALLY EQUIPPED SOLUTION

The Standard Access Port Kits offer an entire solution for the Access Port implantation with a single sterile packed Access Port and standard accessories included.

Reference	Type	Port description	Implantation technique
5400005	Complete Seldinger Kit T605F	Celsite® Safety Small 6.5 F silicone catheter	Seldinger
5400010	Complete Seldinger Kit T601H	Celsite® Safety Standard 8,5 F polyurethane catheter	Seldinger
5400015	Complete Surgical Kit T601F	Celsite® Safety Standard 6.5 F silicone catheter	Surgical cut-down

The following accessories are included in the Standard Access Port Kit configurations:

Skin disinfection

- 1 SUSI® sponge forceps, 200 mm
- 5 Gauze swabs, plum size

Cover

- 1 Cover drape, 148 x 240 cm
- 1 Cover drape, 173 x 180 cm
- 2 Cover drapes sidewise, 75 x 100 cm
- 1 Cover drape, 150 x 170 cm
- 1 Cover drape transparent, adhesive 110 x 120 cm
- 1 Cover drape, 140 x 150 cm (packaging drape)

Compresses and swabs

- 30 Gauze compresses with x-ray strips, 12-ply, 10 x 10 cm
- 5 Gauze swabs, plum size with x-ray strips
- 2 Askina® PAD S compresses with slit, 7.5 x 7.5 cm

Bowls and syringes

- 1 Bowl 250 ml, transparent
- 2 Bowls 500 ml, blue
- 1 3-Pocket tray, 24 x 25 x 5 cm, blue
- 2 Syringes Omnifix® 20 ml, Luer Lock
- 2 Syringes Omnifix® 10 ml, Luer Lock
- 2 Syringes Injekt 20 ml, Luer Slip

Scapels and needles

- 1 Safety scalpel Fig. 11
- 1 Safety scalpel Fig. 15
- 1 Hypodermic Needle Pro® 0.6 x 38 mm, 23 G
- 1 Hypodermic Needle Pro® 0.9 x 38 mm, 20 G
- 1 Surecan® Safety II port needle 20 G x 20 mm
- 1 Needle collector box

Sutures and wound dressing

- 1 Novosyn® uncolored 3/0 (2) 45 cm, DS19 (M)
- 1 Monoplus® violet 4/0 (1,5) 70 cm, HR26 (M)
- 1 Askina® strips, 12 x 102 mm (1 piece = 6 strips)
- 1 Askina® Soft patch, 9 x 10 cm

Miscellaneous

- 2 Coats, size XL
- 2 Universal clamps (model Kiel)
- 1 Table bag, 80 x 144 cm
- 1 Lamp cover
- 1 Suction bag

Further Seldinger equipment

- 1 Safety puncture needle, 18 G x 70 mm, echogenic *
- 1 Intradyn® peelable introducer, 7 F / 9 F *
- 1 Guidewire J3, 50 cm, 0.035", marked each 10 cm *
- 1 Tunneling rod *

* not included in surgical cut-down Standard Access Port Kits

Customized Access Port Kits

ACCESS PORT PORTFOLIO

Wide range of silicone and PUR catheters as well as two different port sizes, standard and small, for the configuration of your individual Access Port Kit. Choose additionally out of more than 3000 accessories for a customer-adapted creation.

	Catheter	OD (F/mm)	ID (mm)	Length (mm)	Flow rate* (ml/min)		325 PSI Recommended maximum flow rates (mL/s) Contrast media at 37°C (325 psi = 22.4 bar)**			Type	Reference
					19 G	22 G	Viscosity up to 11.4 mPa.s (cP)				
							22 G	20 G	19 G		
Celsite® Safety Standard											
	Silicone	6.5 / 2.2	1.1	500	26	10	2	5	5	T601F	4437556K
	Silicone	8.5 / 2.8	1.2	500	34	11	2	5	5	T601L	4437573K
	PUR	6.5 / 2.1	1.4	500	37	12	2	5	5	T601P	4437565K
	PUR	8.5 / 2.8	1.6	500	48	12	2	5	5	T601H	4437581K
Celsite® Safety Small											
	Silicone	6.5 / 2.2	1.1	500	26	10	2	5	5	T605F	4437758K
	Silicone	8.5 / 2.8	1.2	500	34	11	2	5	5	T605L	4437780K
	PUR	6.5 / 2.1	1.4	500	37	12	2	5	5	T605P	4437768K
	PUR	8.5 / 2.8	1.6	500	48	12	2	5	5	T605H	4437773K
Celsite® PSU Standard											
	Silicone	6.5 / 2.2	1.0	800	26	10	2	6	8	T301F	04430000K
	Silicone	8.5 / 2.8	1.1	800	28	13	2	6	9	T301	04430018K
	PUR	8.5 / 2.8	1.6	800	45	12	2	7	9	T301H	04432452K
Celsite® PSU Small											
	Silicone	6.5 / 2.2	1.0	800	24	10	2	5	6	T305	04436903K
Celsite® Epoxy Standard											
	Silicone	6.5 / 2.2	1.1	800	26	10	2	6	8	T201F	04430034K
	Silicone	8.5 / 2.8	1.1	800	28	13	2	6	9	T201	04430026K
Celsite® Epoxy Small											
	Silicone	6.5 / 2.2	1.0	800	24	10	2	5	6	T205	04430085K

PVC FREE	LATEX FREE	DEHP FREE
-------------	---------------	--------------

* Gravity infusion of saline (0.9%) through a 22G respectively 19G needle from a height difference of 1 m and a catheter length of 40 cm. According to ISO10555-1

** Flow rates determined according to ISO 10555-6 with a catheter of 20 cm and Surecan® Safety II 20 mm needle

Premium Solution Concepts

VARIOUS OPTIONS

Using B. Braun Premium Solution Concepts means to design Customized Access Port Kits for implantation procedures. Components can be added or removed to create your individual and complete solution.



Please contact your B. Braun consultant for your individual Access Port Kit or send an email to vascular.systems@bbraun.com.

Distributor

B. Braun Melsungen AG | Vascular Systems | Sieversufer 8 | 12359 Berlin | Germany
Phone +49 30 568 207-300 | Fax +49 30 568 207-130 | www.bbraun.com

Manufacturer acc. to MDD 93/42

B. Braun Médical | 26, rue Armengaud | 92210 Saint-Cloud | France
Tél +33 (0) 1 41 10 53 00 | Fax +33 (0) 1 41 10 53 99 | www.bbraun.fr

The main product trademark 'Aesculap' is a registered trademark of Aesculap AG. The product trademarks „Celsite“, „Surecan“ and „Cytocan“ are registered trademarks of B. Braun Melsungen AG.

Subject to technical changes. All rights reserved. This brochure may only be used for the exclusive purpose of obtaining information about our products. Reproduction in any form partial or otherwise is not permitted.