

# Aesculap Surgical Instruments

ENT Catalog  
HNO Katalog



Aesculap Surgical Technologies

# Think Surgical Instruments. Think Aesculap.

Surgical Instruments. Process Optimization. Support.



**Think Partnership.**  
Think Aesculap.



**Think Competence.**  
Think Aesculap.



**Think Service.**  
Think Aesculap.



**Think Quality.**  
Think Aesculap.

## Knowledge shared is knowledge multiplied!

"Sharing Expertise" has been the B. Braun philosophy for more than 170 years. Sharing expertise across all divisions of the company helps to create a broader and deeper knowledge base for everyone involved and results in far-sighted, detailed solutions and maximum safety for the benefit of both, the patient and healthcare professionals.

With more than 145 years of surgical instrument experience, Aesculap is a competent partner

for interdisciplinary knowledge transfer. The Aesculap brand represents a varied spectrum that intelligently and economically combines high-quality products with process-oriented services. Aesculap is a reliable and accepted partner for the entire surgical process in the hospital.

Aesculap owes its standing among the best in the business to its employees, who are never satisfied with the first idea that comes along

and keep testing, scrutinizing and refining each and every development until they find the best possible solution.

Thus, Aesculap is much more than a supplier of high precision surgical instruments: a partner who listens carefully and contributes ideas, who understands the customer's needs and requirements and provides for them on a high level. From products to services and seminars for all areas of activity within the hospital.

## Think Surgical Instruments. Think Aesculap. Surgical Instruments. Process Optimization. Support.



**Think Economy.**  
Think Aesculap.



**Think Innovation.**  
Think Aesculap.

### Wissen mehrt sich, wenn man es teilt!

Profundes Wissen setzt voraus, Kenntnisse und Erfahrungen zu vernetzen sowie diese folgerichtig zu bewerten.

Diesem Prinzip folgt B. Braun konsequent seit mehr als 170 Jahren, in der Aussage „Sharing Expertise“ spiegelt es sich ausdrücklich wider. Der Wissensaustausch über alle Sparten des Konzerns hinweg schafft eine breitere und somit fundiertere Wissensbasis für alle Beteiligten – insbesondere auch für Aesculap. Das Ergebnis sind bis ins Detail durchdachte, weitsichtige Lösungen und ein Höchstmaß an Sicherheit. Sie dienen dem Wohl des Patienten und dem Interesse der Anwender.

Mit mehr als 145 Jahren Erfahrung im Segment der chirurgischen Instrumente ist Aesculap ein kompetenter Partner für den interdisziplinären Wissensaustausch. Die Produktmarke Aesculap steht für ein vielfältiges Leistungsspektrum, das hochwertige Produkte mit prozessorientierten

Dienstleistungen intelligent und im Sinne der Wirtschaftlichkeit verknüpft.

Aesculap ist ein verlässlicher und akzeptierter Partner für den gesamten chirurgischen Prozessablauf in der Klinik.

Dass Aesculap zu den Besten der Branche gehört, verdankt das Unternehmen seinen Mitarbeiterinnen und Mitarbeitern. Sie geben sich nicht mit der ersten Idee zufrieden, sondern prüfen, hinterfragen und verbessern jede einzelne Entwicklung immer wieder auf der Suche nach der bestmöglichen Lösung.

Deshalb ist Aesculap weit mehr als ein Lieferant hochpräziser chirurgischer Instrumente: Aesculap ist ein Partner, der genau zuhört und mitdenkt, die Bedürfnisse und Anforderungen seiner Kunden versteht und sie auf hohem Niveau versorgt. Vom Produkt über die Dienstleistungen bis zu den Seminaren für alle Funktionsbereiche.

**Otology,  
Micro Ear Surgery**

Otologie, Mikro Ohrchirurgie

1 - 48

**FESS, Rhinology,  
Rhinoplasty**FESS, Rhinologie, Septum- und  
Nasenplastik

49 - 116

**Adenoidectomy,  
Tonsillectomy**

Adenotomie, Tonsillektomie

117 - 150

**Laryngology**

Laryngologie

151 - 162

**Micro Vascular  
Surgery**

Mikro Gefäßchirurgie

163 - 198

**Bone  
Instruments**

Knocheninstrumente

199 - 272

273 - 338

Retraktoren, Wundhaken



**Retractors,  
Hooks**

Content  
Inhalt

- Surgical Instruments**
- 339 - 356 ————— Patient Preparation
  - 357 - 372 ————— Scalpels
  - 373 - 426 ————— Scissors
  - 427 - 456 ————— Forceps
  - 457 - 498 ————— Clamps
  - 499 - 514 ——— Needle Holder, Ligature Instruments
  - 515 - 524 ——— Probes, Cotton Carriers, Redon Spike
  - 525 - 544 ————— Suction Instruments, Syringes

**Chirurgische Instrumente**

- 339 - 356 ————— Patienten-Vorbereitung
- 357 - 372 ————— Skalpelle
- 373 - 426 ————— Scheren
- 427 - 456 ————— Pinzetten
- 457 - 498 ————— Klemmen
- 499 - 514 ——— Nadelhalter, Ligatur-Instrumente
- 515 - 524 ——— Sonden, Watteträger, Redon Spieße
- 525 - 544 ————— Sauginstrumente, Spritzen



**Surgical  
Instruments**

545 - 554

Aufbereitung



**Reprocessing**

555 - 573

Alphabetical Index

574 - 592

Alphabetischer Index

593 - 610

Numerical Index  
Nummernverzeichnis

**Index**

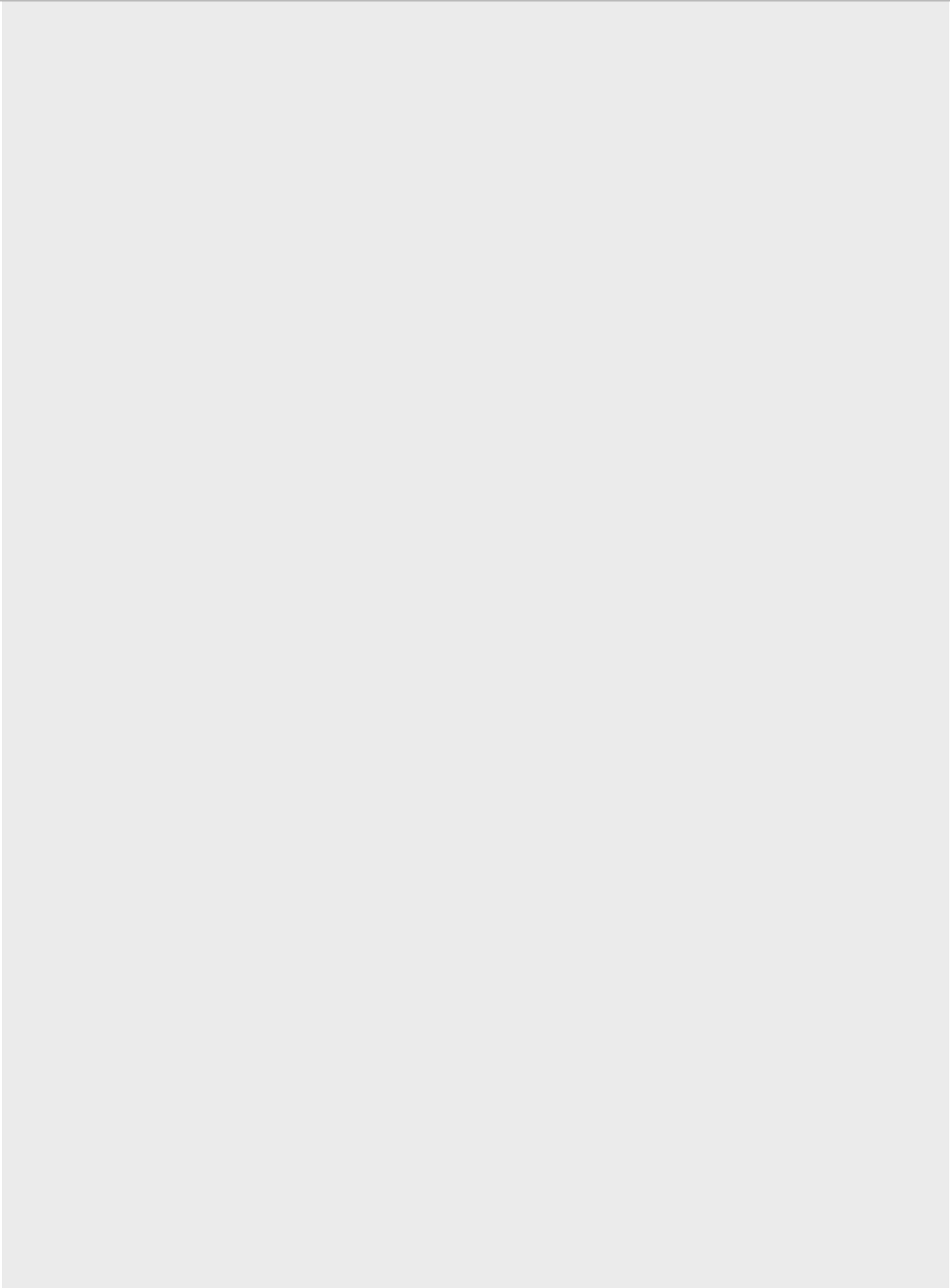

Otology, Micro Ear Surgery  
Otologie, Mikro-Ohrchirurgie



# Otology, Micro Ear Surgery – Otologie, Mikro-Ohrchirurgie

## Ear Specula

### Ohrspekula

Otology  
Otologie



POLITZER

Art. No. Art. Nr.	Inner diam. Innen-Ø	Sales unit Bestelleinheit
OF101C		Set of 3 sizes Satz à 3 Stück
OF102C	2.0 mm ○	
OF103C	3.0 mm ○	
OF104C	4.0 mm ○	
for children für Kinder		

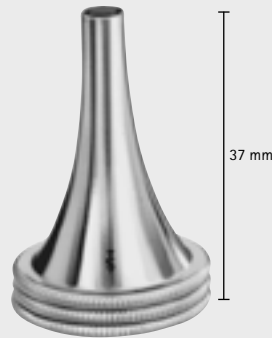

HARTMANN

Art. No. Art. Nr.	Inner diam. Innen-Ø	
OF115C	1.8 mm	○
OF116C	3.2 mm	○
OF117C	4.6 mm	○
for children für Kinder		

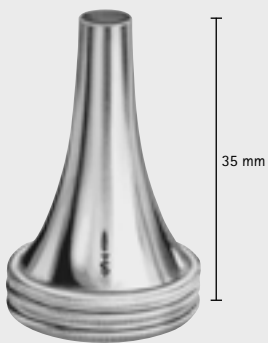

HARTMANN

Art. No. Art. Nr.	Inner diam. Innen-Ø	Sales unit Bestelleinheit
OF108C		Set of 3 sizes / Satz à 3 Stück (OF111C, OF112C, OF113C)
OF111C	3.5 mm ○	
OF112C	5.0 mm ○	
OF113C	6.5 mm ○	
OF114C	8.0 mm ○	
for adults für Erwachsene		



BOUCHERON

Art. No. Art. Nr.	Inner diam. Innen-Ø	Sales unit Bestelleinheit
OF120C		Set of 4 sizes Satz à 4 Stück
OF121C	4 mm ○	
OF122C	5 mm ○	
OF123C	6 mm ○	
OF124C	7 mm ○	
for adults für Erwachsene		



# Otology, Micro Ear Surgery – Otologie, Mikro-Ohrchirurgie

## Ear Specula

## Ohrspekula

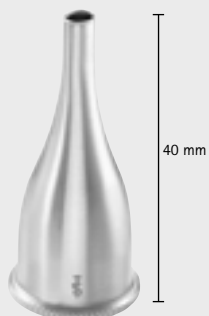

GRUBER

Art. No. Art. Nr.	Inner diam. Innen-Ø	
OF161	2.8 x 3.5 mm	○
OF162	4.0 x 4.6 mm	○
OF163	5.2 x 6.2 mm	○
OF164	6.4 x 7.8 mm	○

oval lumen  
oval



HARTMANN

Art. No. Art. Nr.	Outside diam. Außen-Ø	
OF313R	3.0 mm	○
OF314R	4.0 mm	○
OF315R	5.0 mm	○
OF316R	6.0 mm	○
OF317R	7.5 mm	○

round lumen, stainless steel  
rund, Edelstahl



TOYNBEE

Art. No. Art. Nr.	Inner diam. Innen-Ø	Sales unit Bestelleinheit
OF125C		Set of 3 sizes Satz à 3 Stück
OF126C	4.0 mm	○
OF127C	5.5 mm	○
OF128C	7.0 mm	○

for adults  
für Erwachsene

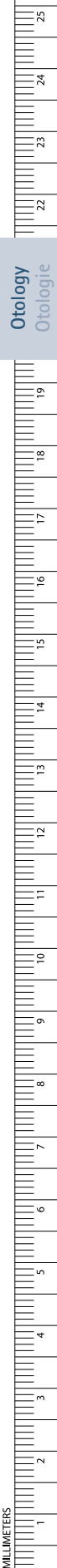

MILLIMETERS

# Otology, Micro Ear Surgery – Otologie, Mikro-Ohrchirurgie

## Ear Specula

### Ohrspekula

Otology  
Otologie

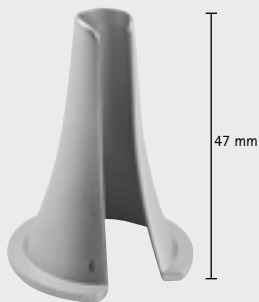

TUMARKIN

Art. No. Art. Nr.	Inner diam. Innen-Ø	Sales unit Bestelleinheit
OF290		Set of 8 sizes Satz à 8 Stück
OF291	3.2 mm	
OF292	5.1 mm	
OF293	5.6 mm	
OF294	6.2 mm	
OF295	6.6 mm	
OF296	7.0 mm	
OF297	7.6 mm	
OF298	9.6 mm	

tapered slot  
geschlitzt



ROSEN

Art. No. Art. Nr.	Inner diam. Innen-Ø
OF093	3.0 mm
OF094	4.0 mm
OF095	5.0 mm
OF096	6.0 mm
OF097	7.0 mm

round lumen  
rund

INCHES

## Otology, Micro Ear Surgery – Otologie, Mikro-Ohrchirurgie

Ear Specula

Ohrspekula



ROSEN

Art. No. Art. Nr.	Inner diam. Innen-Ø	
OF043	3.3 x 4.1 mm	○
OF044	4.0 x 5.5 mm	○
OF045	5.0 x 7.5 mm	○
OF046	6.0 x 8.5 mm	○
OF047	7.0 x 9.5 mm	○

oval lumen  
oval

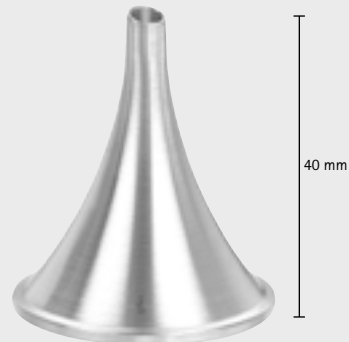

SHEA

Art. No. Art. Nr.	Inner diam. Innen-Ø	Sales unit Bestelleinheit
OF150		Set of 5 sizes Satz à 5 Stück
OF151	3.5 x 4.0 mm	○
OF152	3.9 x 5.5 mm	○
OF153	5.0 x 7.4 mm	○
OF154	5.8 x 8.3 mm	○
OF155	7.3 x 9.7 mm	○

oblique ended  
abgeschrägt

## Otology, Micro Ear Surgery – Otologie, Mikro-Ohrchirurgie

Flexible Arm, Ear Specula Holder, Nystagmus Spectacles

Spannarm, Ohrspekulahalter, Nystagmusbrille

Otology  
Otologie



YASARGIL

**FF270R**

Flexible arm only, mobile in all directions  
Spannarm allein, umsteckbar und nach allen  
Richtungen beweglich



**FF266R**

Fixation base for mounting flexible arm FF270R to the bow  
or the rail of the operating table  
Fixiervorrichtung zum Befestigen des Spannarmes FF270R  
am Bügel oder der Stange des OP-Tisches



**FF275R**

Ear specula holder only, for specula:  
OF111C-OF114C, OF115C-OF117C, OF126C-OF128C  
Ohrspekulahalter allein, passend für die Spekula:  
OF111C-OF114C, OF115C-OF117C, OF126C-OF128C



**OF080**

Nystagmus spectacles for observation of the eyes during  
examination of the vestibular apparatus, with battery handle  
and fixed glasses. Illuminated on inside of lenses.  
Source of energy: 2 baby-battery cells, 1.5 volts, not included  
2 bulbs, 4 volt, OF081

Beleuchtete Nystagmusbrille mit querliegendem  
Batteriehandgriff und festen Gläsern

Energiequelle: 2 Stück Baby-Zellen 1,5 Volt, nicht im  
Lieferumfang enthalten  
2 Stück 4-Volt-Lämpchen OF081



**OF081**

Spare bulb, 4 volt  
for Nystagmus spectacles OF080  
Ersatz-Birnen 4 Volt  
für Nystagmusbrillen OF080

# Otology, Micro Ear Surgery – Otologie, Mikro-Ohrchirurgie

## Tuning Forks

## Stimmgabeln



1/2

HARTMANN

Art. No. Art. Nr.	Frequency Frequenz
OF001N	c <sup>1</sup> 128
OF002N	c <sup>1</sup> 256
OF003N	c <sup>2</sup> 512
OF004N	c <sup>3</sup> 1024
OF005N	c <sup>4</sup> 2048
OF006N	c <sup>5</sup> 4096



1/2

Art. No. Art. Nr.	Frequency Frequenz
OF010N	a <sup>1</sup> 440



1/2

LUCAE

Art. No. Art. Nr.	Frequency Frequenz
OF015N	c <sup>1</sup> 128
OF016N	c <sup>1</sup> 256
OF017N	c <sup>2</sup> 512
OF018N	c <sup>3</sup> 1024
OF019N	c <sup>4</sup> 2048



1/2

LUCAE

Art. No. Art. Nr.	Frequency Frequenz
OF031N	c <sup>1</sup> 128

for neurologists  
für den Neurologen



1/2

RYDEL-SEIFFER

Art. No. Art. Nr.	Frequency Frequenz
OF033N	with clamp mit Dämpfer c 64 without clamp ohne Dämpfer c 128

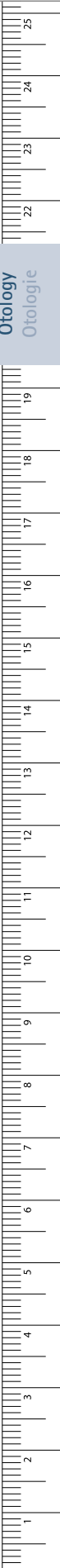

Otology  
Otologie

# Otology, Micro Ear Surgery – Otologie, Mikro-Ohrchirurgie

Eustachian Catheters, Ear Probes, Cerumen Scoop

Tubenkatheter, Ohrsonden, Zerumenlöffel

Otology  
Otologie



HARTMANN

Art. No.	Diam. (mm)
Art. Nr.	Ø (mm)
OF250C	2.0
OF251C	2.5
OF252C	3.0
OF253C	4.0
OF254C	5.0

Eustachian catheter  
Tubenkatheter



JOBSON HORNE

Art. No.	Length
Art. Nr.	Länge
OF266R	140 mm, 5 1/2"
OF267R	180 mm, 7"

Ear probes  
Ohrsonden



FORMBY

**OF360R**  
Cerumen scoop and hook  
Zerumenlöffel und-Häkchen  
180 mm, 7"

- Please find further probes and cotton carriers in chapter probes, starting on page 515
- Für weitere Sonden und Watteträger, siehe Kapitel Sonden, ab Seite 515

# Otology, Micro Ear Surgery – Otologie, Mikro-Ohrchirurgie

## Sickle Knives, Tympanum Perforators, Myringotomes

### Sichelmesser, Paracentesenadel, Myringotome



$\frac{1}{1}$

$\frac{1}{2}$

**POLITZER**  
**OF600R**  
Sickle knife  
Sichelmesser  
160 mm, 6 1/4"



$\frac{1}{1}$

**OF614R**  
for children  
für Kinder  
160 mm  
6 1/4"

**OF615R**  
for adults  
für Erwachsene  
190 mm  
7 1/2"

**OF618R**  
for children,  
handle 90° angled  
to the lancet  
für Kinder  
Grifffläche 90°  
zur Lanzette  
180 mm  
7"

**LUCAS**  
**OF614R-OF618R**  
Tympanum perforator, bayonet-shaped  
Paracentesenadel, bajonettförmig



$\frac{1}{1}$

$\frac{1}{2}$

**POLITZER**  
**OF608R**  
Tympanum perforator, angled  
Paracentesenadel, kniegebogen  
160 mm, 6 1/4"



$\frac{1}{1}$

$\frac{1}{2}$

**AGNEW (POLITZER)**  
**OF610R**  
Myringotome, angled  
Myringotom, kniegebogen  
175 mm, 6 7/8"



$\frac{1}{1}$

$\frac{1}{2}$

adjustable blade,  
reversing into handle  
verstellbare Klinge,  
im Handgriff versenkbar

**OF626R**  
Universal-Myringotome  
Universal-Myringotom  
170 mm, 6 3/4"

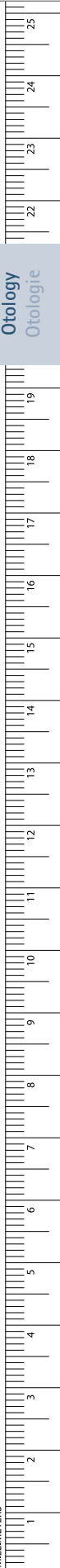

# Otology, Micro Ear Surgery – Otologie, Mikro-Ohrchirurgie

Ear Loops, Ear Elevator, Cerumen Pick and Wool Carrier

Ohrschlingen, Ohrheber, Zerumennadel und Watteträger

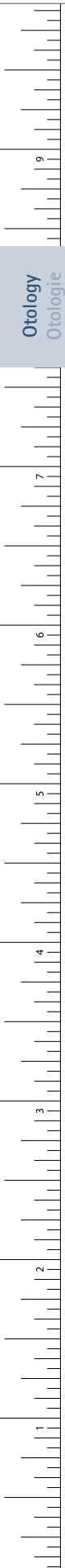

Otology  
Otologie

3 mm    4 mm

OF271R    OF272R

**BILLEAU**  
OF271R-OF272R  
Ear loop, straight  
Ohrschlinge, gerade  
160 mm, 6 1/4"

WEBER / SNELLEN

Art. No.	Size	Width	Length
Art. Nr.	Größe	Breite	Länge
OF270R	0	3 mm	145 mm, 5 3/4"
OF268R	1	3.5 mm	145 mm, 5 3/4"

Ear loop, curved and serrated  
Ohrschlinge, gebogen und gerieft

**ZAUFAL**  
OF274R  
Ear elevator, blunt  
Ohrheber, stumpf  
150 mm, 6"

**MUSGROVE**  
OF361R  
Cerumen pick and wool carrier  
Zerumennadel und Watteträger  
180 mm, 7"



## Otology, Micro Ear Surgery – Otologie, Mikro-Ohrchirurgie

## Ear Currettes

## Ohrküretten

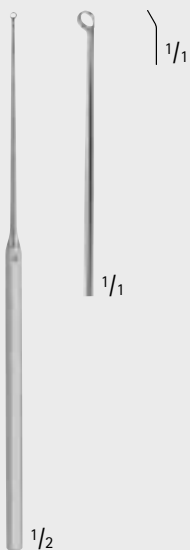

BUCK

Art. No. Art. Nr.	Figure Figur	Outside diam. Außen-Ø (mm)	
OF350R	00	1.5	○
OF351R	0	2.0	○
OF352R	1	2.5	○
OF353R	2	3.0	○
OF354R	3	4.0	○

curved, sharp  
gebogen, scharf  
150 mm, 6"

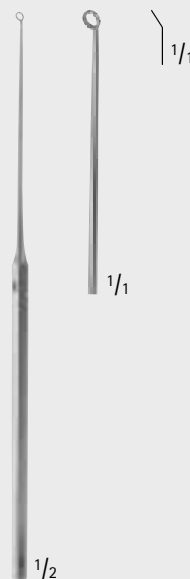

BUCK

Art. No. Art. Nr.	Figure Figur	Outside diam. Außen-Ø (mm)	
OF355R	00	1.5	○
OF356R	0	2.0	○
OF357R	1	2.5	○
OF358R	2	3.0	○
OF359R	3	4.0	○

curved, blunt  
gebogen, stumpf  
150 mm, 6"

# Otology, Micro Ear Surgery – Otologie, Mikro-Ohrchirurgie

## Ear Hooks, Cerumen Hook

Ohrhäkchen, Ohrhebel, Zerumenhäkchen



Otology  
Otologie

OF282R   OF283R   OF284R   OF285R

1/1

1/2

**WAGENER**  
**OF282R-OF285R**  
Ear hooks  
Ohrhäkchen  
150 mm, 6"

1/1

1/2

**ST. BARTS**  
**OF288R**  
Ear hook, blunt  
Ohrhäkchen, stumpf  
180 mm, 7"

OF277R   OF278R   OF279R

1/1

1/2

**LUCAE**  
**OF277R-OF279R**  
Ear hooks, probe ended  
Ohrhebel, geknöpft  
140 mm, 5 1/2"

# Otology, Micro Ear Surgery – Otologie, Mikro-Ohrchirurgie

## Ear Snare, Ear Snare Wire, Ear Forceps

### Ohrpolypenschnürer, Ohrpolypenschlingen, Fremdkörperinstrumente

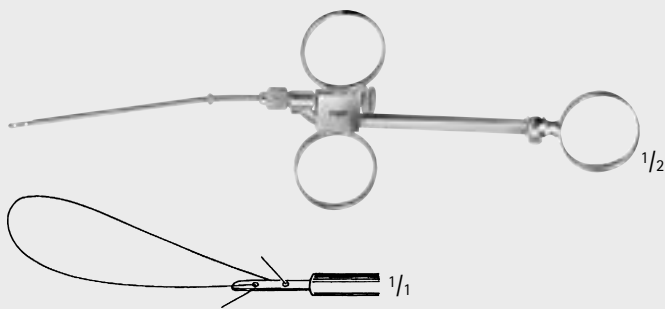

KRAUSE

**OF505R**

Ear snare

Ohrpolypenschnürer

160 mm, 6 1/4"

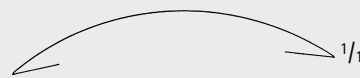

**OF528R**

Ear snare wire

Sales unit: PAK = Package of 100 pieces

Ohrpolypen-Schlingen

Bestelleinheit: PAK = Packung à 100 Stück

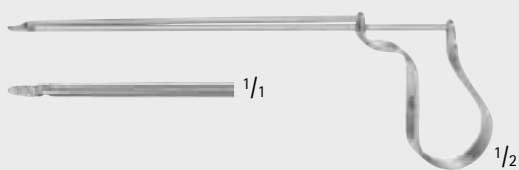

QUIRE

**OF300R**

Ear forceps

for removal of foreign bodies

Fremdkörperinstrument

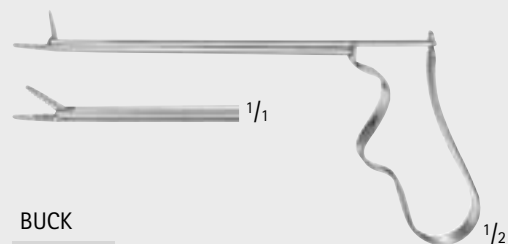

BUCK

**OF303R**

Ear forceps, alligator type, serrated jaws,

for removal of foreign bodies

Fremdkörperinstrument

Otology  
Otologie

MILLIMETERS

# Otology, Micro Ear Surgery – Otologie, Mikro-Ohrchirurgie

## Micro Scissors with Tubular Shaft

### Rohrschaft-Mikro-Scherchen



- The LUER-Lock flushing ports of tubular shaft instruments allow easy cleaning of the instruments as well as lubrication with a steam permeable oil (e.g. Aesculap Sterilit®).
- Die LUER-Lock Spülanschlüsse bei Rohrschaft-Instrumenten ermöglichen eine einfache Reinigung der Instrumente, sowie die Pflege mit einem dampfdurchlässigen Öl (z.B. Aesculap Sterilit®).

Otology  
Otologie

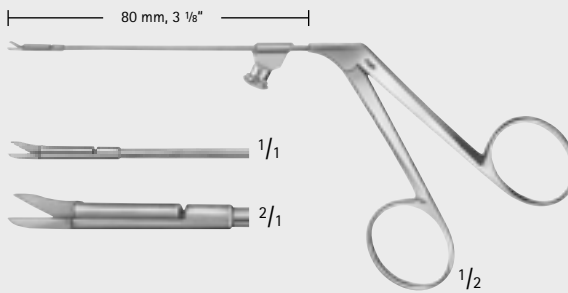

BELLUCCI  
OG350R-OG355R

**OG350R**

straight, sharp/sharp  
gerade, spitz/spitz



**OG351R**

upwards curved, blunt/blunt  
nach oben gebogen, stumpf/stumpf

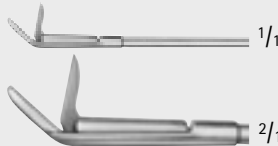

**OG352R**

left curved, sharp/sharp  
nach links gebogen, spitz/spitz



**OG353R**

right curved, sharp/sharp  
nach rechts gebogen, spitz/spitz



**OG355R**

horizontal cutting  
horizontal schneidend



INCHES

# Otology, Micro Ear Surgery – Otologie, Mikro-Ohrchirurgie

## Micro Scissors, Micro Crurotomy Scissors

### Mikro-Scherchen, Mikro-Crurotomiescherchen

**OG354R** 4.0 x 1.5 mm  
straight, sharp/sharp  
gerade, spitz/spitz

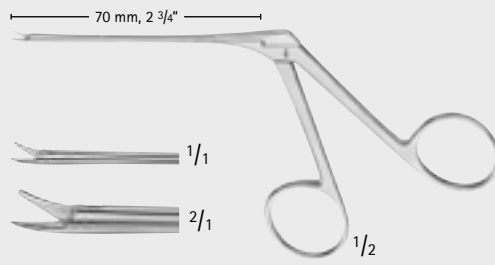

CAWTHORNE

**OG354R**

Micro scissors

Mikro-Ohrscherchen

**OG356R**  
left curved  
links gebogen

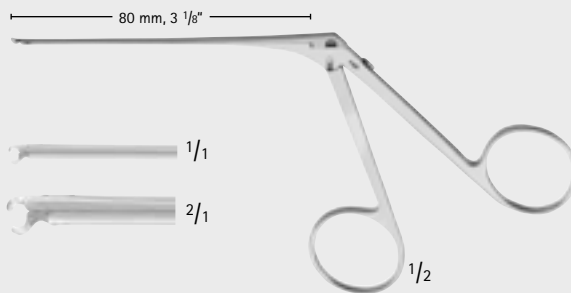

**OG356R-OG357R**

Micro crurotomy scissors

Mikro-Crurotomiescherchen

**OG357R**  
right curved  
rechts gebogen

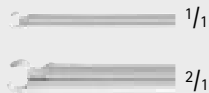

Otology  
Otologie

MILLIMETERS

# Otology, Micro Ear Surgery - Otologie, Mikro-Ohrchirurgie

## Alligator Forceps

### Mikro-Fasszängchen



Otology  
Otologie

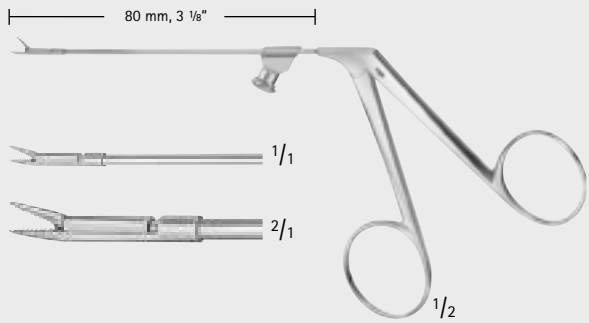

**OG330R** 0.8 x 4.5 mm  
straight  
gerade

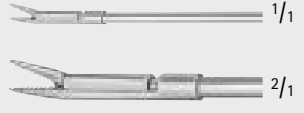

**OG325R-OG330R**

**OG335R** 1.0 x 5.0 mm  
straight  
gerade

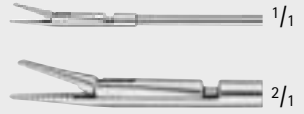

**OG325R** 1.5 x 6.5 mm  
straight  
gerade



# Otology, Micro Ear Surgery – Otologie, Mikro-Ohrchirurgie

## Alligator Forceps Mikro-Fasszängchen

**OG331R** 0.8 x 3.5 mm  
65° upwards curved  
65° nach oben gebogen

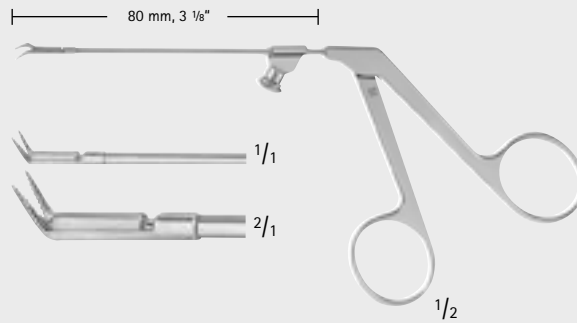

**OG331R-OG339R**

**OG332R** 0.8 x 3.5 mm  
45° downwards curved  
45° nach unten gebogen



**OG338R** 1.0 x 5.0 mm  
left curved  
links gebogen

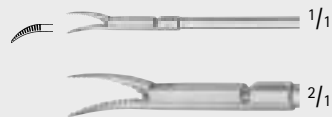

**OG339R** 1.0 x 5.0 mm  
right curved  
rechts gebogen



Otology  
Otologie

MILLIMETERS

# Otology, Micro Ear Surgery – Otologie, Mikro-Ohrchirurgie

## Micro Ear Forceps, Ear Forceps

### Mikro-Fasszängchen, Fasszängchen



HOUGH

**OG329R** 1.0 x 5.0 mm  
straight  
gerade

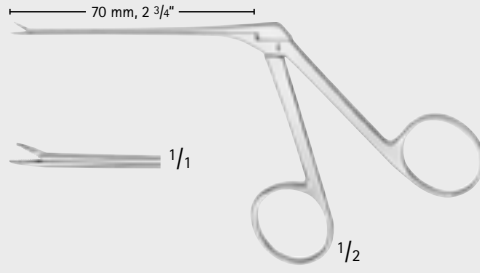

CAWTHORNE

**OG334R** 1.25 x 5.0 mm  
straight, smooth jaw  
gerade, glattes Maul



**OG329R-OG334R**

Micro ear forceps  
Mikro-Fasszängchen

**OF410R** 0.5 x 6.0 mm  
straight  
gerade

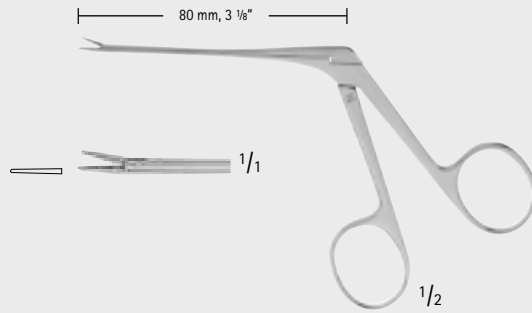

**OF414R** 1 x 8 mm  
straight  
gerade



HARTMANN-WULLSTEIN

**OF410R-OF414R**

Ear forceps  
Fasszängchen

**OF411R** 1 x 8 mm  
straight  
gerade

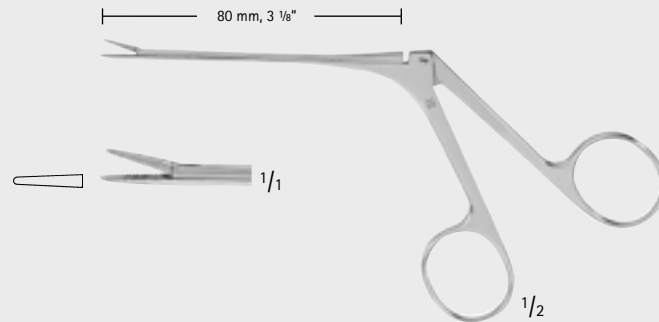

**OF420R** 1 x 8 mm  
straight, 1 x 2 teeth  
gerade, 1 x 2 Zähne



HARTMANN

**OF411R-OF420R**

Ear forceps  
Fasszängchen



# Otology, Micro Ear Surgery – Otologie, Mikro-Ohrchirurgie

## Micro Cup Forceps Mikro-Löffelzängchen

**OG341R** 0.9 x 1.0 mm  
straight, oval jaw  
gerade, Maul oval

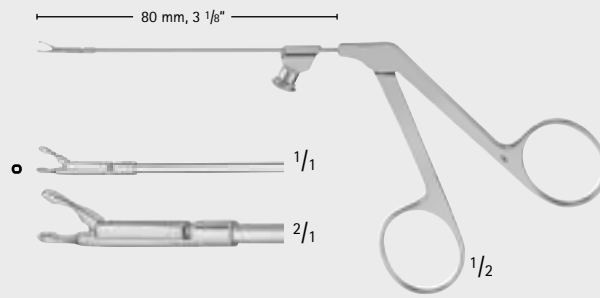

**OG341R-OG348R**

WULLSTEIN

**OG345R** 0.8 x 1.3 mm  
straight, oval jaw  
gerade, Maul oval

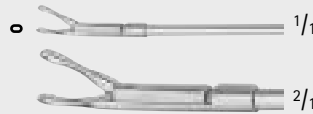

WULLSTEIN

**OG346R** Diam. / Ø 1.0 mm  
straight, round jaw  
gerade, Maul rund



WULLSTEIN

**OG348R** 1.7 x 2.5 mm  
straight, oval jaw  
gerade, Maul oval



Otology  
Otologie

MILLIMETERS

# Otology, Micro Ear Surgery – Otologie, Mikro-Ohrchirurgie

## Micro Cup Forceps

### Mikro-Löffelzängchen

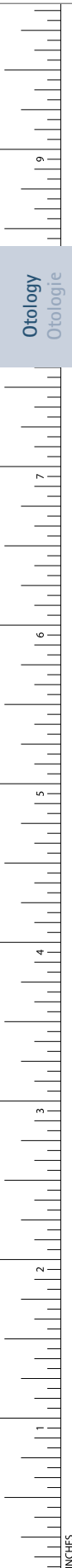

Otology  
Otologie

**OG342R** 0.9 x 1.0 mm  
upwards curved, oval jaw  
nach oben gebogen, Maul oval

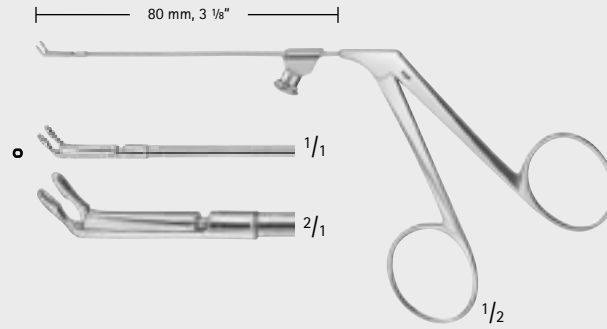

**OG342R-OG344R**

WULLSTEIN

**OG343R** 0.8 x 1.3 mm  
left curved, oval jaw  
links gebogen, Maul oval

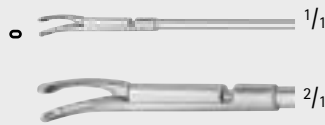

WULLSTEIN

**OG344R** 0.8 x 1.3 mm  
right curved, oval jaw  
rechts gebogen, Maul oval

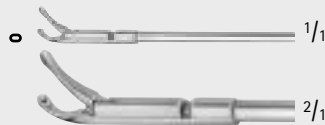

# Otology, Micro Ear Surgery – Otologie, Mikro-Ohrchirurgie

## Cup Forceps Löffelzängchen

HARTMANN-WULLSTEIN

**OF442R** Diam. / Ø 1 mm  
delicate, straight, round jaw  
fein, gerade, Maul rund

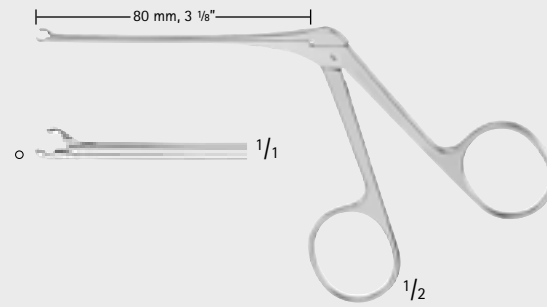

**OF438R-OF442R**

HARTMANN-WULLSTEIN

**OF444R** Diam. / Ø 2 mm  
delicate, straight, round jaw  
fein, gerade, Maul rund



HARTMANN

**OF438R** Diam. / Ø 2 mm  
straight, round jaw  
gerade, Maul rund



HARTMANN

**OF439R** Diam. / Ø 2.5 mm  
straight, round jaw  
gerade, Maul rund



HARTMANN

**OF440R** Diam. / Ø 3 mm  
straight, round jaw  
gerade, Maul rund



Otology  
Otologie

MILLIMETERS

# Otology, Micro Ear Surgery – Otologie, Mikro-Ohrchirurgie

## Cup Forceps

### Löffelzängchen

Otology  
Otologie



#### HARTMANN-CITELLI

**OF448R** Diam. / Ø 2 mm  
upwards curved, round jaw  
aufgebogen, Maul rund

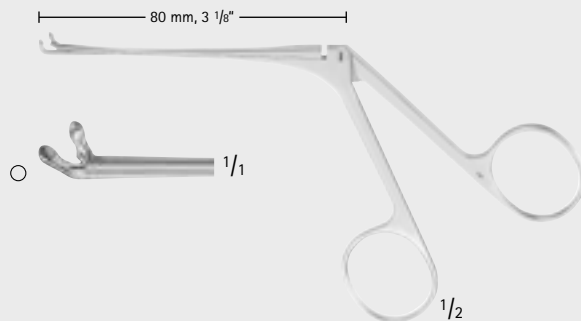

#### HARTMANN

**OF425R** 2 x 7 mm  
straight, round jaw  
gerade, Maul rund



**OF425R-OF448R**

#### ORMEROD

**OF423R** 4.0 x 1.7 mm  
straight, oval jaw  
gerade, Maul oval

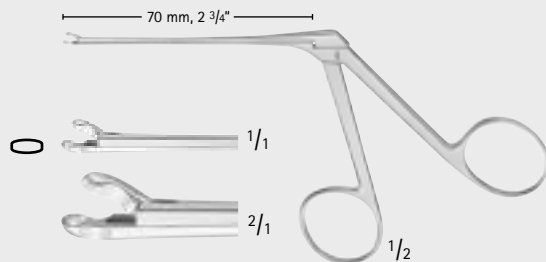

**ORMEROD  
OF423R**

#### OF424R

5 x 1 mm  
straight, round jaw  
gerade, Maul rund

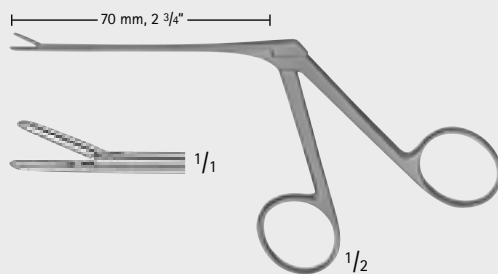

**ORMEROD  
OF424R**

# Otology, Micro Ear Surgery – Otologie, Mikro-Ohrchirurgie

## Malleus Nipper, Micro Wire Bending Forceps

### Mikro-Stanzen, Mikro-Drahtbiegezängchen

DIETER

**OG300R**

Malleus nipper,  
upwards cutting

Mikro-Stanze,  
nach oben schneidend

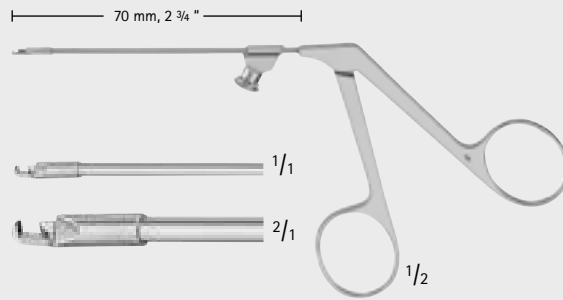

**OG300R-OG360R**

DIETER

**OG301R**

Malleus nipper,  
downwards cutting

Mikro-Stanze,  
nach unten schneidend



MC GEE

**OG359R**

Wire bending forceps,  
curved down

jaw length: 3.5 mm  
Mikro-Drahtbiegezängchen,  
nach unten gebogen,  
Maullänge: 3,5 mm



MC GEE

**OG360R**

Wire bending forceps,  
curved down

jaw length: 5 mm  
Mikro-Drahtbiegezängchen,  
nach unten gebogen,  
Maullänge: 5 mm

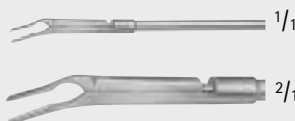

Otology  
Otologie

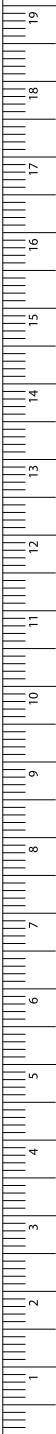

# Otology, Micro Ear Surgery – Otologie, Mikro-Ohrchirurgie

## Ear Forceps, Ear Tampon Forceps

### Löffelzängchen, Ohrtamponzangen

Otology  
Otologie



80 mm, 3 1/8"

**HENCKEL**  
**OF431R** 3 x 5 mm  
Ear forceps, flat oval spoon, fenestrated  
Löffelzängchen, oval, gefenstert

**HARTMANN**  
**OF403R**  
Ear tampon forceps, delicate pattern  
Ohrtamponzange, feines Modell  
135 mm, 5 1/4"

**HARTMANN**  
**OF405R**  
Ear tampon forceps, strong pattern  
Ohrtamponzange, kräftiges Modell  
135 mm, 5 1/4"

**TILLEY**  
**OF407R**  
Ear tampon forceps, extra fine pattern  
Ohrtamponzange, extra feines Modell  
140 mm, 5 1/2"

- For bone instruments see chapter bone instruments, starting on page 199
- For hooks see chapter retractors and hooks, starting on page 273
- For general instruments see chapter instruments, on page 339
- Knocheninstrumente siehe Kapitel Knocheninstrumente, ab Seite 199
- Häkchen siehe Kapitel Retraktoren und Wundhaken, ab Seite 273
- Allgemeines Instrumentarium siehe Kapitel Instrumente, ab Seite 339

# Otology, Micro Ear Surgery – Otologie, Mikro-Ohrchirurgie

## Micro Needles

## Mikro-Nadeln

Otology  
Otologie

MILLIMETERS



**OG001R-OG006R**

160 mm, 6 1/4"



**WULLSTEIN**

**OG001R**

straight, sharp/sharp  
gerade, spitz/spitz



**WULLSTEIN**

**OG006R**

slightly curved, sharp  
leicht gebogen, spitz



**OG002R**

curved, sharp  
gebogen, spitz



**OG003R**

strong curved, sharp, delicate  
stark gebogen, spitz, fein



**ROSEN**

**OG005R**

curved, sharp  
gebogen, spitz

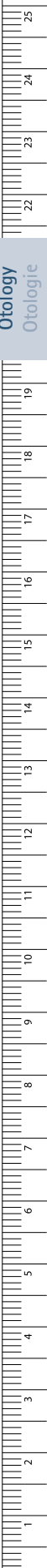

# Otology, Micro Ear Surgery – Otologie, Mikro-Ohrchirurgie

## Micro Perforators

### Mikro-Perforatoren



Otology  
Otologie



**OG070R-OG075R**

160 mm, 6 1/4"



**OG070R**  
Diam. 0.3 mm  
Ø 0,3 mm



**OG071R**  
Diam. 0.4 mm  
Ø 0,4 mm



**OG072R**  
Diam. 0.5 mm  
Ø 0,5 mm



**OG073R**  
Diam. 0.6 mm  
Ø 0,6 mm



**OG074R**  
Diam. 0.7 mm  
Ø 0,7 mm



**OG075R**  
Diam. 0.8 mm  
Ø 0,8 mm



# Otology, Micro Ear Surgery – Otologie, Mikro-Ohrchirurgie

## Micro Hooks

## Mikro-Häkchen

Otology  
Otologie

MILLIMETERS



1/1

SHAMBAUGH

OG007R-OG086R

45° angled

45° abgewinkelt

160 mm, 6 1/4"



1/1 2/1

OG007R

0.4 mm



1/1 2/1

OG008R

0.6 mm



1/1 2/1

OG009R

0.8 mm



1/1 2/1

OG010R

1.0 mm



1/1 2/1

OG084R

1.5 mm



1/1 2/1

OG085R

2.0 mm



1/1 2/1

OG086R

2.5 mm

# Otology, Micro Ear Surgery – Otologie, Mikro-Ohrchirurgie

## Micro Hooks

## Mikro-Häkchen



Otology  
Otologie



1/1

SHAMBAUGH

OG011R-OG083R

90° angled

90° abgewinkelt

160 mm, 6 1/4"



1/1 2/1

OG011R

0.4 mm



1/1 2/1

OG012R

0.6 mm



1/1 2/1

OG013R

0.8 mm



1/1 2/1

OG014R

1.0 mm



1/1 2/1

OG080R

1.2 mm



1/1 2/1

OG081R

1.5 mm



1/1 2/1

OG082R

2.0 mm



1/1 2/1

OG083R

2.5 mm

# Otology, Micro Ear Surgery – Otologie, Mikro-Ohrchirurgie

## Micro Footplate Hooks

## Mikro-Fußplatten-Häkchen

$\frac{1}{1}$   $\frac{2}{1}$   
**OG015R**  
0.2 mm

$\frac{1}{1}$   $\frac{2}{1}$   
**OG035R**  
0.4 mm

$\frac{1}{1}$   $\frac{2}{1}$   
**OG016R**  
0.6 mm

$\frac{1}{1}$

**PLESTER**  
**OG015R-OG035R**  
90° angled, blunt  
90° abgewinkelt, stumpf  
160 mm, 6 1/4"

$\frac{1}{1}$   $\frac{2}{1}$   
1.0 mm

$\frac{1}{1}$

**OG021R**  
retrograde curved  
retrograd gebogen  
160 mm, 6 1/4"

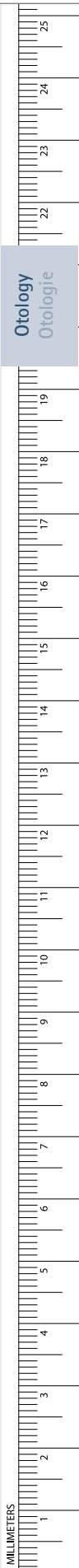

# Otology, Micro Ear Surgery – Otologie, Mikro-Ohrchirurgie

## Micro Hooks, Micro Scraper, Antrum Hooks

### Mikro-Häkchen, Mikro-Schaber, Antrumhäkchen

Otology  
Otologie



**OG023R-OG038R**  
160 mm, 6 1/4"



**OG036R** 0.4 mm  
Micro hook,  
slightly angled tip  
Mikro-Häkchen,  
Arbeitsende leicht  
abgewinkelt



**HOUGH**  
**OG034R** 0.3 mm  
Micro hook,  
90° angled tip  
shaft slightly angled  
Mikro-Häkchen,  
Arbeitsende 90° abgewinkelt  
Schaft leicht abgewinkelt

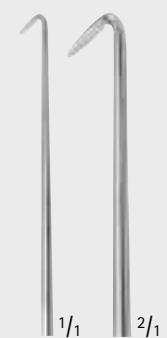

**PLESTER**  
**OG023R** 2.0 mm  
Micro scraper,  
60° angled  
Mikro-Schaber,  
60° abgewinkelt

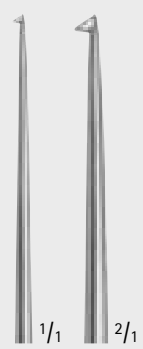

**OG031R** 0.6 mm  
Micro hook,  
reverse cutting  
Mikro-Häkchen,  
retrograd schneidend



**PLESTER**  
**OG037R**  
Antrum hook,  
90° angled  
Antrumhäkchen,  
90° abgewinkelt



**PLESTER**  
**OG038R**  
Antrum hook,  
45° angled  
Antrumhäkchen,  
45° gebogen

# Otology, Micro Ear Surgery – Otologie, Mikro-Ohrchirurgie

Application Instrument, Stapes Mobiliser, Micro Knives, Micro Sickle Knives  
 Applikationsinstrument, Steigbügelhäkchen, Mikro-Messer, Mikro-Sichelmesser



PLESTER

**OG040R**

Wire guide and applicator for prostheses with wire loop, flat end  
 Applikationsinstrument (Führungsgabel, Stapesreiter) für Stapesprothesen mit Drahtschlinge, Arbeitsende flach  
 160 mm, 6 1/4"



HUGHES

**OG042R**

Stapes mobiliser  
 Steigbügelhäkchen  
 165 mm, 6 1/2"

**OG040R-OG042R**



OG100R

Micro knife, straight  
 Mikro-Messer, gerade  
 160 mm, 6 1/4"



PLESTER

**OG101R**

Micro sickle knife, slightly curved  
 Mikro-Sichelmesser, leicht gebogen  
 160 mm, 6 1/4"



THORBURN

**OG104R**

Micro sickle knife, curved  
 Mikro-Sichelmesser, gebogen  
 165 mm, 6 1/2"

**OG100R-OG104R**

Otology  
 Otologie

MILLIMETERS

# Otology, Micro Ear Surgery – Otologie, Mikro-Ohrchirurgie

## Micro Flap Knives, Micro Lancet Knife

### Mikro-Lappenmesser, Mikro-Lanzettmesser



Otology  
Otologie



**OG105R**  
a x b  
2.4 x 3.0 mm



**OG106R**  
a x b  
2.4 x 3.5 mm



**OG107R**  
a x b  
2.0 x 4.0 mm



**OG109R**  
a x b  
2.5 x 4.5 mm

<sup>1</sup>/<sub>1</sub>  
PLESTER

**OG105R-OG109R**  
Micro flap knives, cutting all around  
Mikro-Lappenmesser, rundum schneidend  
160 mm, 6 1/4"



<sup>1</sup>/<sub>1</sub>  
ROSEN

**OG108R**  
Micro lancet knife  
Mikro-Lanzettmesser  
160 mm, 6 1/4"

# Otology, Micro Ear Surgery – Otologie, Mikro-Ohrchirurgie

## Micro Round Cutting Knives

### Mikro-Rundmesser



**OG125R**

Diam. 1.0 mm  
Ø 1,0 mm



**OG126R**

Diam. 1.5 mm  
Ø 1,5 mm



**OG127R**

Diam. 2.0 mm  
Ø 2,0 mm



**OG128R**

Diam. 2.5 mm  
Ø 2,5 mm



**OG129R**

Diam. 3.0 mm  
Ø 3,0 mm

**OG125R-OG129R**

straight  
gerade  
160 mm, 6 1/4"

Otology  
Otologie

MILLIMETERS

# Otology, Micro Ear Surgery – Otologie, Mikro-Ohrchirurgie

## Micro Round Cutting Knives

### Mikro-Rundmesser



Otology  
Otologie



**OG110R-OG133R**

45° angled  
45° abgewinkelt  
160 mm, 6 1/4"



**OG131R**  
Diam. 1.0 mm  
Ø 1,0 mm



**OG133R**  
Diam. 1.5 mm  
Ø 1,5 mm

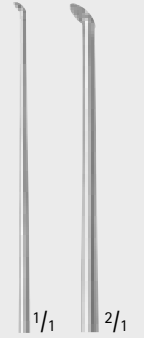

**OG110R**  
Diam. 2.0 mm  
Ø 2,0 mm



**OG112R**  
Diam. 2.6 mm  
Ø 2,6 mm



**OG132R**  
Diam. 3.0 mm  
Ø 3,0 mm



# Otology, Micro Ear Surgery – Otologie, Mikro-Ohrchirurgie

## Micro Round Cutting Knives, Micro Roller Knives

### Mikro-Rundmesser, Mikro-Rollmesser



**OG136R**

Diam. 1.5 mm  
Ø 1,5 mm

**OG116R**

3 mm  
3 mm

**OG116R-OG136R**

Micro round cutting knives,  
90° angled  
Mikro-Rundmesser,  
90° abgewinkelt  
160 mm, 6 1/4"

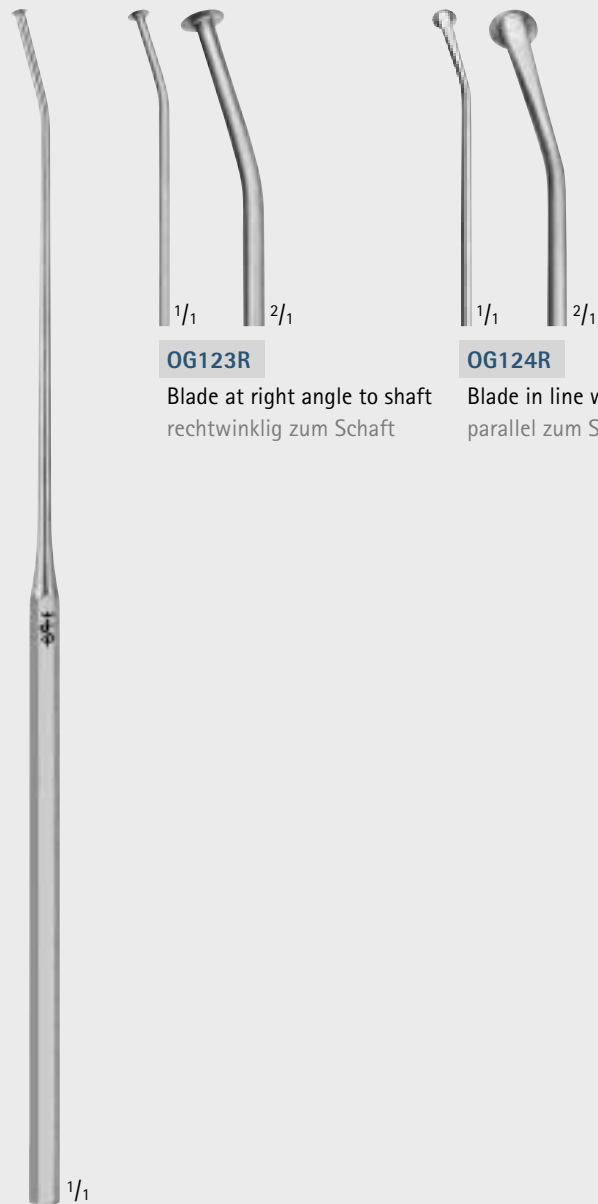

**OG123R**

Blade at right angle to shaft  
rechtwinklig zum Schaft

**OG124R**

Blade in line with shaft  
parallel zum Schaft

**SCHUKNECHT**

**OG123R-OG124R**

Micro roller knives  
Mikro-Rollmesser  
160 mm, 6 1/4"

## Otology, Micro Ear Surgery – Otologie, Mikro-Ohrchirurgie

Transplant Holder, Stapes Elevator, Micro Raspatory

Transplantat-Träger, Stapes Elevatorium, Mikro-Raspatorium

Otology  
Otologie



**OG048R-OG051R**

160 mm, 6 1/4"



**OG048R**

Transplant holder  
and raspatory  
Transplantat-Träger  
und Raspatorium



**OG050R**

Stapes elevator,  
slightly angled  
Stapes Elevatorium,  
leicht abgewinkelt



**OG051R**

Micro raspatory,  
round tip, slightly angled  
Mikro-Raspatorium,  
Spitze rund, leicht aufgebogen

# Otology, Micro Ear Surgery – Otologie, Mikro-Ohrchirurgie

## Micro Raspatories, Micro Dissectors

## Mikro-Raspatorien, Mikro-Dissektoren

**OG054R**  
left curved  
nach links gebogen

**OG053R**  
right curved  
nach rechts gebogen

**OG056R**  
double left curved  
doppelt nach links gebogen

**OG055R**  
double left right  
doppelt nach rechts gebogen

**OG053-OG056R**  
Micro raspatories  
Mikro-Raspatorien  
160 mm, 6 1/4"

**OG060R**  
double left curved  
doppelt nach links gebogen

**OG061R**  
double right curved  
doppelt nach rechts gebogen

**OG060R-OG061R**  
Micro dissectors  
Mikro-Dissektoren  
160 mm, 6 1/4"

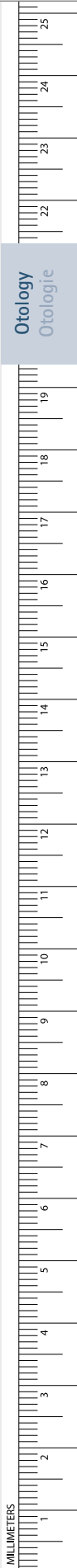

# Otology, Micro Ear Surgery – Otologie, Mikro-Ohrchirurgie

## Micro Raspatories, Raspatory

### Mikro-Raspatorien, Raspatorium

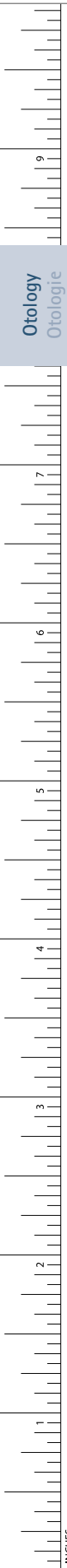

Otology  
Otologie

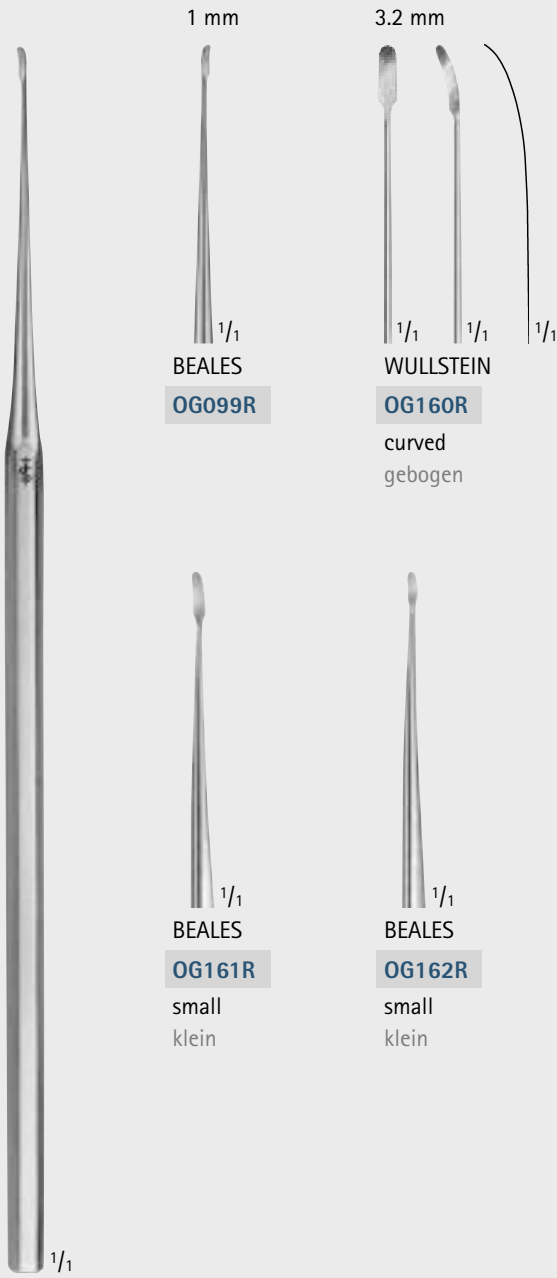

1 mm

3.2 mm

BEALES  
OG099R

WULLSTEIN  
OG160R  
curved  
gebogen

BEALES  
OG161R  
small  
klein

BEALES  
OG162R  
small  
klein

OG099R-OG162R

Micro raspatories  
Mikro-Raspatorien  
165 mm, 6 1/2"



3 mm

1/1  
straight  
gerade

LEMPERT  
OG163R

Raspatory  
Raspatorium  
190 mm, 7 1/2"

# Otology, Micro Ear Surgery – Otologie, Mikro-Ohrchirurgie

Measuring Instruments, Preparation Tray, Vein Graft Press Forceps

Messinstrumente, Präpariertablett, Implantate Presszange



**OG140R**

Measuring instrument,  
marker pins at 3.5 - 4.0 - 4.5 mm  
Messinstrument,  
Markierungen bei 3,5 - 4,0 - 4,5 mm  
160 mm, 6 1/4"



**OG141R**

Measuring instrument  
Messinstrument  
165 mm, 6 1/2"



**OG145R**

92 x 54 mm

Preparation tray,  
with mm scale, stainless steel  
Präpariertablett aus Metall,  
mit mm-Skala

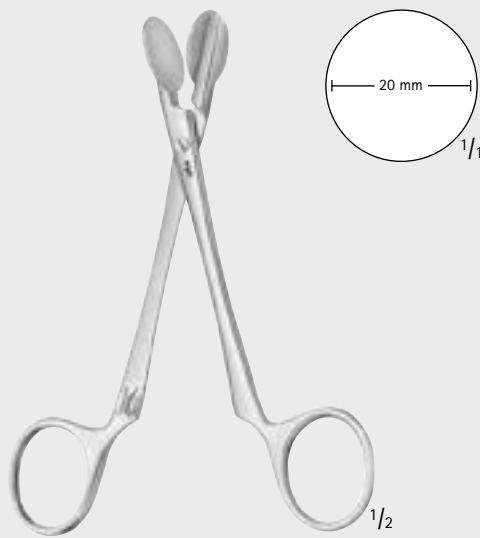

KING

**OG066R**

Vein graft press forceps,  
smooth jaws  
Implantate-Presszange,  
glattes Maul  
140 mm, 5 1/2"

# Otology, Micro Ear Surgery – Otologie, Mikro-Ohrchirurgie

## Curettes

### Scharfe Löffel



Otology  
Otologie

2.8 x 3.2 mm

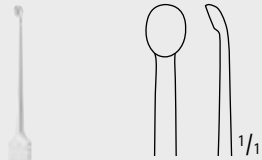

HOUSE  
2.6 x 3.5 mm

**OG178R**

oval cups, large  
oval, groß  
150 mm, 6"

2.2 x 3.8 mm

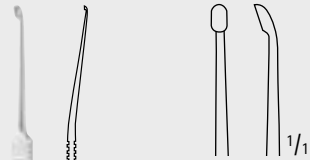

HOUSE  
2.8 x 4.8 mm

**OG179R**

oval cups, extra large  
oval, extra groß  
150 mm, 6"

0.6 x 0.8 mm

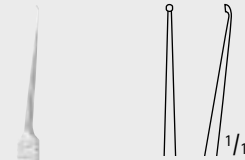

HOUSE  
0.8 x 1.0 mm

**OG186R**

oval cups, angled  
oval, kniegebogen  
150 mm, 6"

1.5 x 2.5 mm



SHEA

**OG180R**

oval cups  
oval  
160 mm, 6 1/4"

# Otology, Micro Ear Surgery – Otologie, Mikro-Ohrchirurgie

## Curettes

### Scharfe Löffel



1/2

1/1 2/1

HOUSE

Art. No. Art. Nr.	Tip Arbeitsende
<b>OG181R</b>	Diam. 1.0 + 1.2 mm Ø 1,0 + 1,2 mm
<b>OG182R</b>	Diam. 1.5 + 1.8 mm Ø 1,5 + 1,8 mm

oval cups  
oval  
150 mm, 6"

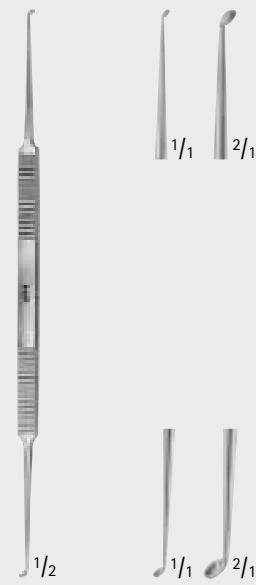

1/2

1/1 2/1

HOUSE

Art. No. Art. Nr.	Tip Arbeitsende
<b>OG184R</b>	Diam. 1.0 + 1.2 mm Ø 1,0 + 1,2 mm
<b>OG185R</b>	Diam. 1.5 + 1.8 mm Ø 1,5 + 1,8 mm

oval cups, strongly angled  
oval, stark abgewinkelt  
150 mm, 6"



1/2

1/1 2/1

**OG189R**

angled cups, pointed, large  
abgebogen, spitz, groß  
170 mm, 6 3/4"

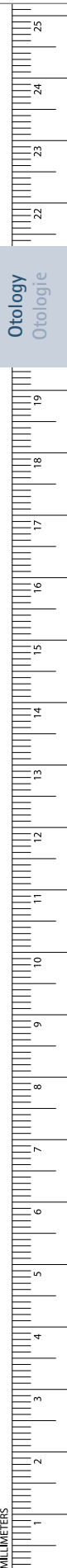

Otology  
Otologie

MILLIMETERS

# Otology, Micro Ear Surgery – Otologie, Mikro-Ohrchirurgie

## Instruments for the Removal of the Stapedial Footplate

### Instrumentarium zur Ausmeißelung der Stapes-Fußplatte



Otology  
Otologie



1/2

HEERMANN

**OG202R-OG207R**

180 mm, 7"

0.7 mm



1/1 2/1

**OG202R**

Chisel,  
very delicate  
Flachmeißel,  
sehr fein

0.7 mm



1/1 2/1

**OG203R**

Gouge,  
very delicate  
Hohlmeißel,  
sehr fein

1.5 mm



1/1 2/1

**OG205R**

Gouge  
for fenestration  
Hohlmeißel  
für Fenestration

1.5 mm



1/1 2/1

**OG206R**

Gouge  
for fenestration  
Hohlmeißel  
für Fenestration

3 mm



1/1 2/1

**OG207R**

Gouge  
for fenestration  
Hohlmeißel  
für Fenestration



1/2

HEERMANN

**OG201R**

Handle to hold instruments (OG202R - OG207R).  
The knurled screw allows fixation in any desired position

Handgriff für die Spezialmeißel (OG202R - OG207R).  
Die Meißel können mit der Feststellschraube in jeder Position fixiert werden



1/2

HEERMANN

**OG209R**

Mallet, metal,  
with hollow handle, with narrow head  
Metallhammer mit Hohlheft  
195 mm, 7 3/4"



## Otology, Micro Ear Surgery – Otologie, Mikro-Ohrchirurgie

## Suction Cannulas

## Saugkanülen



PLESTER

**OG970R****Suction set, complete, consisting of:**

OG971R 1 Suction handle with finger cut-off, with LUER cone

OG972R 2 Suction cannulas, diam. 0.5 mm, with LUER cone

OG973R 2 Suction cannulas, diam. 0.7 mm, with LUER cone

OG974R 2 Suction cannulas, diam. 1.0 mm, with LUER cone

OG969R 2 Suction cannulas, diam. 1.3 mm, with LUER cone  
not included:

OG982R 2 Suction cannulas, diam. 1.5 mm, with LUER cone

OG983R 2 Suction cannulas, diam. 2.0 mm, with LUER cone

OG984R 2 Suction cannulas, diam. 2.5 mm, with LUER cone

**Saugset komplett, bestehend aus:**

OG971R 1 Saughandgriff mit Unterbrecher, mit LUER-Konus

OG972R 2 Saugkanülen, Ø 0,5 mm, mit LUER-Konus

OG973R 2 Saugkanülen, Ø 0,7 mm, mit LUER-Konus

OG974R 2 Saugkanülen, Ø 1,0 mm, mit LUER-Konus

OG969R 2 Saugkanülen, Ø 1,3 mm, mit LUER-Konus

nicht im Set enthalten:

OG982R 2 Saugkanülen, Ø 1,5 mm, mit LUER-Konus

OG983R 2 Saugkanülen, Ø 2,0 mm, mit LUER-Konus

OG984R 2 Saugkanülen, Ø 2,5 mm, mit LUER-Konus

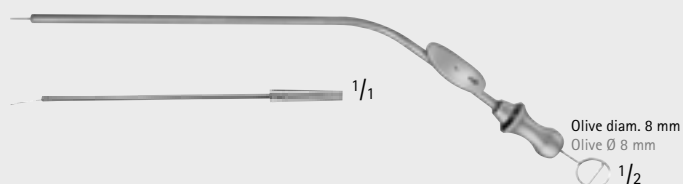

BELLUCCI

**OG950R****Suction set, complete, consisting of:**

OG951R Suction tube with finger cut-off and stylet, 155 mm, 6 1/8"

GF774R Detachable end, 24 swg. diam., 0.5 mm diam.

GF773R Detachable end, 22 swg. diam., 0.7 mm diam.

GF772R Detachable end, 20 swg. diam., 1.0 mm diam.

**Saugset komplett, bestehend aus:**

OG951R Saugrohr, allein, mit Saugunterbrecher und Mandrin, 155 mm, 6 1/8"

GF774R Saugkanüle, Ø 24 swg., Ø 0,5 mm

GF773R Saugkanüle, Ø 22 swg., Ø 0,7 mm

GF772R Saugkanüle, Ø 20 swg., Ø 1,0 mm

# Otology, Micro Ear Surgery – Otologie, Mikro-Ohrchirurgie

## Suction Cannulas, Suction Adapter

### Saugkanülen, Saugadapter

Otology  
Otologie



**ZOELLNER**

Art. No. Art. Nr.	Diam. (swg) Ø (swg)	Diam. (mm) Ø mm	Length Länge
<b>GF771R</b>	18	1.2	55 mm, 2 1/4"
<b>GF772R</b>	20	1.0	55 mm, 2 1/4"
<b>GF773R</b>	22	0.7	55 mm, 2 1/4"

detachable tips, fitting GF770R and OG951R

Sales unit:

PAK = Package of 10 pieces

auswechselbare Spitzen zu GF770R und OG951R

Bestelleinheit:

PAK = Packung à 10 Stück



**VERHOEVEN**

Art. No. Art. Nr.	Diam. (swg) Ø (swg)	Diam. (mm) Ø mm	Length Länge
<b>GF763R</b>	16	1.5	100 mm, 4"
<b>GF764R</b>	18	1.2	100 mm, 4"
<b>GF765R</b>	20	1.0	100 mm, 4"
<b>GF766R</b>	22	0.7	100 mm, 4"

Suction cannulas with LUER cone

Saugkanülen mit LUER-Konus



Olive diam. 7 mm  
Olive Ø 7 mm

**HOUSE**

**GF768R**

Suction adapter with finger cut-off,

LUER cone / LUER hub

Saugadapter mit Saugunterbrecher,

LUER-Konus / LUER-Bohrung

55 mm, 2 1/8"



Diam. 2.5 mm  
Ø 2,5 mm

Olive diam. 8 mm  
Olive Ø 8 mm

**ZOELLNER**

**GF770R**

Suction cannula, only, with stylet

fitting to the detachable ends GF771R and GF775R

Saugkanüle allein, mit Mandrin,

passend zu den Saugkanülen GF771R und GF775R

180 mm, 7"

- Please find further suction instruments in our separate chapter suction instruments, starting on page 525
- Für weitere Sauginstrumente, siehe Kapitel Sauginstrumente, ab Seite 525

# Otology, Micro Ear Surgery – Otologie, Mikro-Ohrchirurgie

## Racks for Micro Ear Instruments

## Rack für Mikro-Ohr-Instrumente

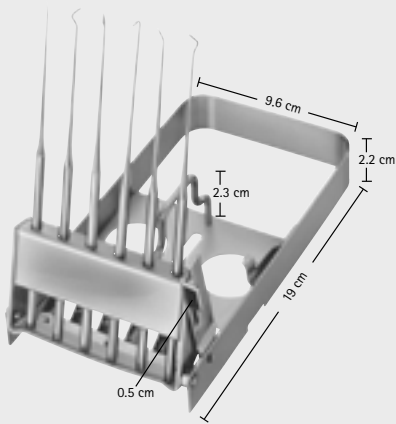

### OG150R

Rack for 6 micro ear instruments with hexagonal or octagonal handle  
 Rack für 6 Mikro-Ohr-Instrumente mit Sechs- oder Achkantgriff

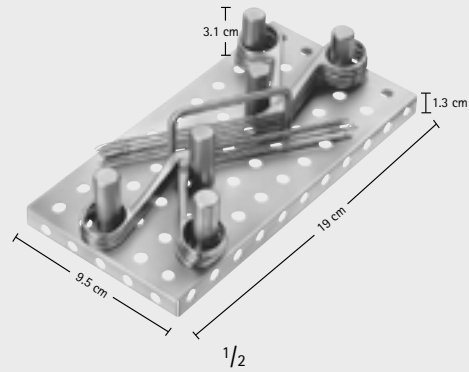

### OG320R

Rack for approximately 8 micro ear forceps  
 Rack für ca. 8 Mikro-Ohr-Ringzängchen

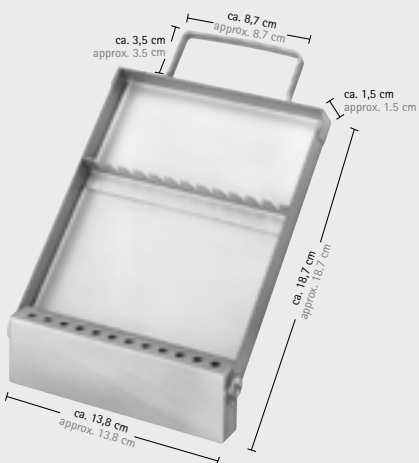

### OG151R

Rack for 12 micro ear instruments  
 Rack für 12 Mikro-Ohr-Instrumente

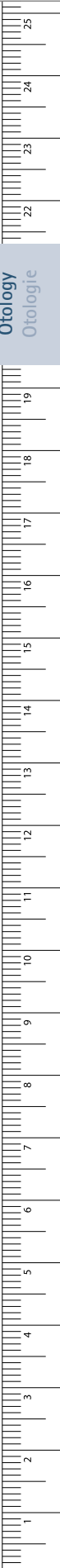

# Otology, Micro Ear Surgery – Otologie, Mikro-Ohrchirurgie

Aesculap® Instrument Organisation System

Aesculap® Instrumenten Organisations System

## Aesculap InOS® – The Smile System

Aesculap® Instrument Organisation System



### simply a good idea

Our Aesculap InOS® organisation system is an ingenious way to keep sterile goods organized, making it easy for you to carry out procedures efficiently. This versatile system has been precisely tailored to Aesculap instrument trays and is easy to assemble.

### einfache Idee

Mit dem frischen Organisations System Aesculap InOS® für die Sterilgutversorgung machen wir Ihnen clevere Ordnung und effiziente Vorgänge leicht. Das facettenreiche System ist präzise auf Aesculap Siebkörbe abgestimmt und einfach zu montieren. Die Stege werden in Sekunden einfach mit Pin oder Klammer befestigt. Fertig!



### simply protected

Fine (working) tips need to be protected as much as possible. With Aesculap InOS®, that's no problem at all! This product's soft components, made from latex-free silicone, provide a soft cushion that nevertheless keeps everything firmly in place. The accurately fitting instrument racks, mats with nubs and mesh mats for Aesculap instrument baskets provide ideal storage for these delicate instruments and hold them securely in place.

### einfach geschützt

Feine Spitzen und Arbeitsenden brauchen größtmöglichen Schutz. Mit Aesculap InOS® kein Problem! Die soften Elemente aus latexfreiem Silikon bilden hier ein sanftes und doch fest haltendes Ruhekissen. Die passgenauen Stege, Noppen- und Netzmatte für Aesculap Siebkörbe nehmen die empfindlichen Instrumente auf und lagern sie zuverlässig.



### simply good value

Our clever Aesculap InOS® system shows that instruments can be kept tidy and protected in a cost-effective way. Are you tired of micro scissors with ruined tips, bent spring catches or damaged optics? Then try Aesculap InOS®!

### einfach clever

Dass Instrumentenordnung und -schutz auch clever sein können, zeigen wir mit unserem ausgeklügelten System Aesculap InOS®. Zerstörte Spitzen von Mikroschere, verbogene Federgriffe oder zerbrochene Glaskörper in Optiken? Probieren Sie Aesculap InOS®!



### simply organized

With this organisation system for sterile goods tidiness is a given even under difficult storage conditions. Aesculap InOS® features around 70 elements, which you can combine in any way you like and integrate into Aesculap instrument baskets really easily. So everything is clearly in its place, can be checked at a glance, is well organised and is to hand when needed.

### einfach ordentlich

Mit diesem System für die Sterilgutversorgung kommt die Ordnung auch bei schwierigen Lageraufgaben ganz von selbst. Die rund 70 Aesculap InOS® Elemente können Sie beliebig kombinieren und ganz einfach in Aesculap Siebkörbe integrieren. Da ist alles übersichtlich an seinem Platz, mit einem schnellen Blick zu prüfen, bestens organisiert und damit griffbereit für den Einsatz.

# Otology, Micro Ear Surgery – Otologie, Mikro-Ohrchirurgie

Aesculap® Instrument Organisation System

Aesculap® Instrumenten Organisations System

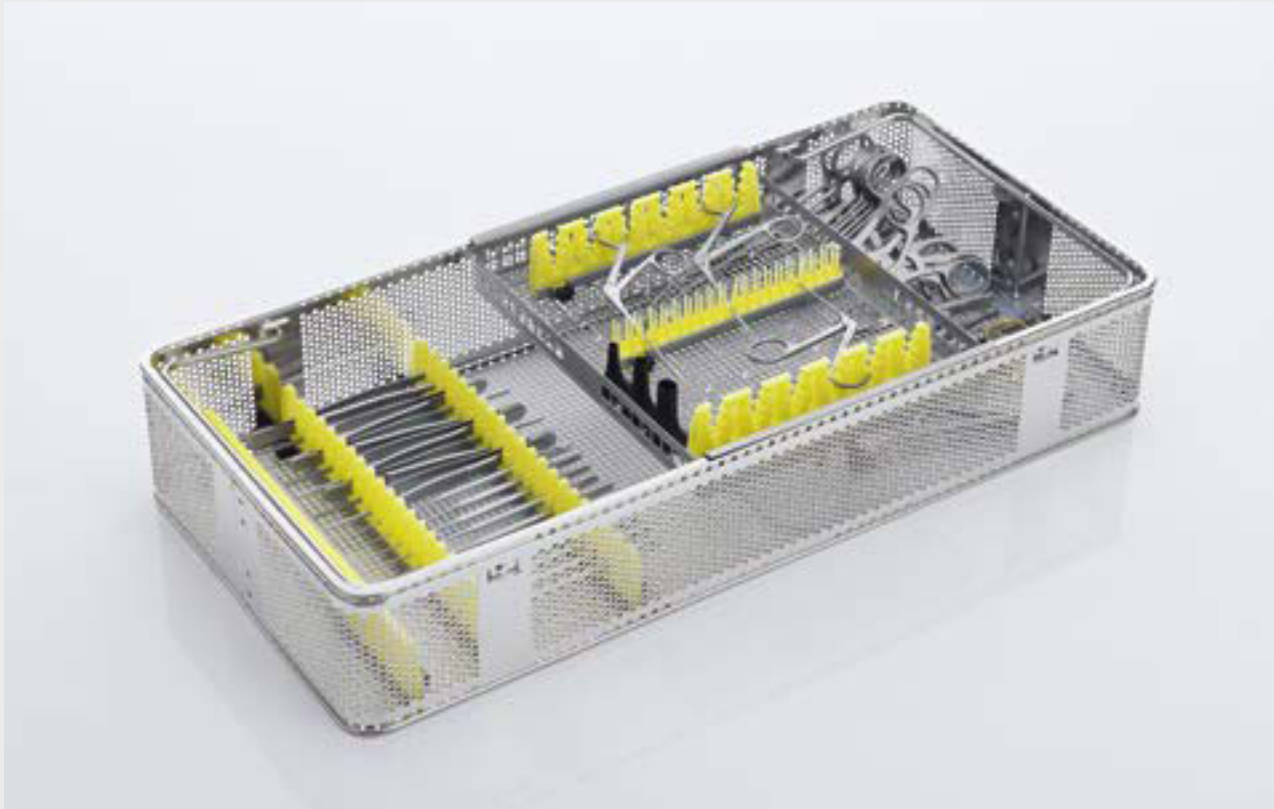

Storage Sample: Tympanoplasty Set

Lagerungsbeispiel: Tympanoplastik-Sieb

- For further details about Aesculap® Instrument Organisation System see brochure no. C81902
- Weitere Informationen über Aesculap® Instrumenten Organisation System finden Sie im Prospekt Nr. C81901
  
- For further informations about storage trays and containers see brochure no. C40402
- Weitere Informationen über Lagerungstray und Container finden Sie im Prospekt Nr. C40401

# Otology, Micro Ear Surgery – Otologie, Mikro-Ohrchirurgie

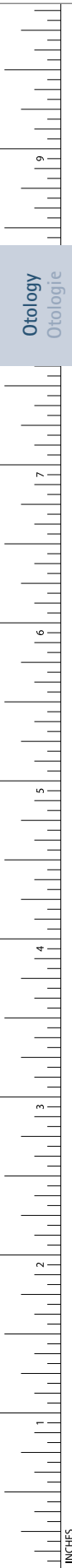

Otology  
Otologie

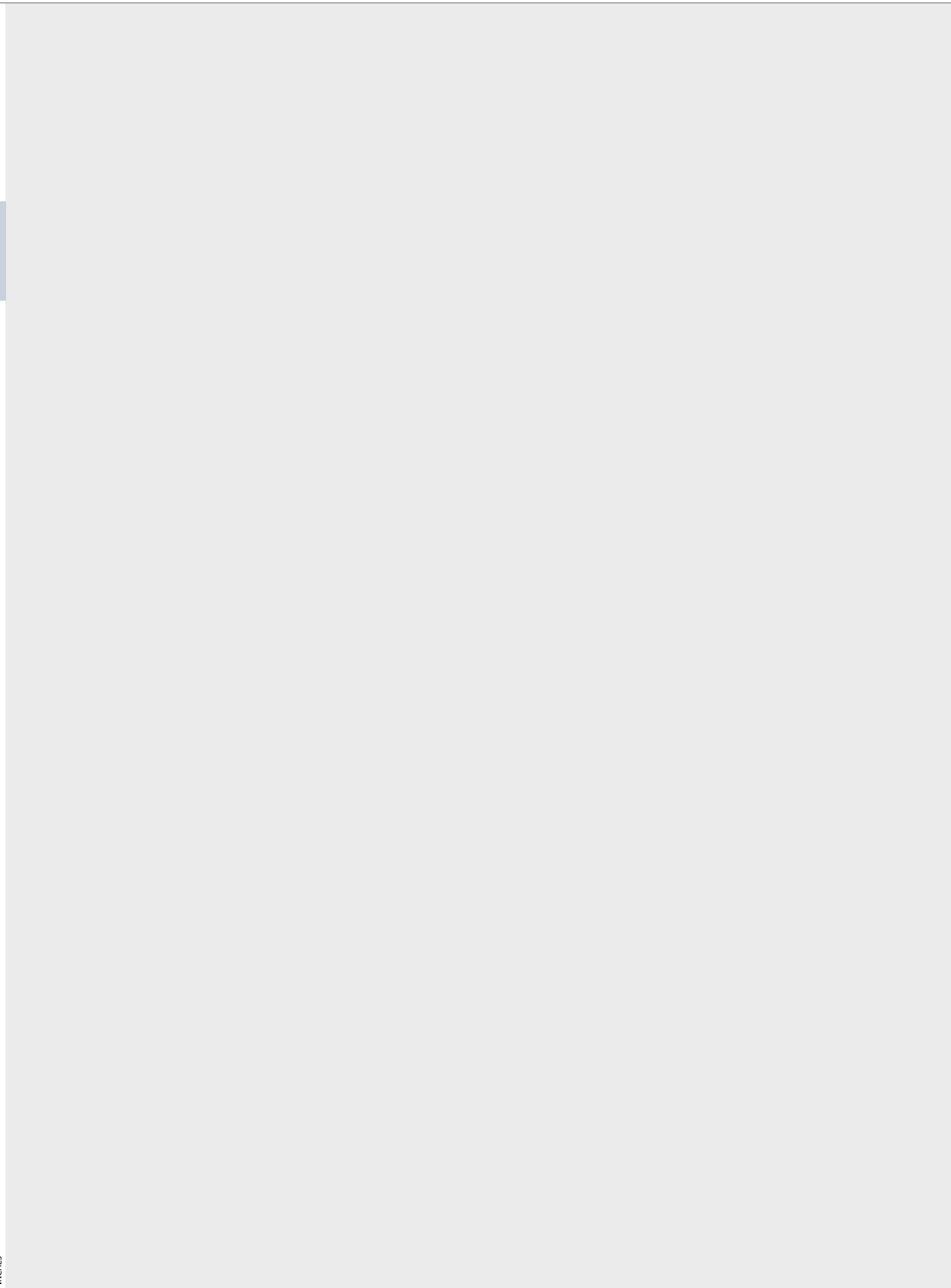

FESS, Rhinology, Rhinoplasty  
FESS, Rhinologie, Septum- und Nasenplastik



# FESS, Rhinology, Rhinoplasty – FESS, Rhinologie, Septum- und Nasenplastik

## Nasal Specula

### Nasenspekula

Rhinology  
Rhinologie



THUDICHUM (MARK HOVELL)

Art. No.	Blade size (mm)	Length
Art. Nr.	Blattgröße (mm)	Länge
OK161R	6.0 x 8.5	70 mm
OK162R	7.0 x 9.0	71 mm
OK163R	8.0 x 12.5	72 mm
OK164R	8.5 x 15.0	73 mm
OK165R	9.0 x 16.5	74 mm
OK166R	10.0 x 18.0	74 mm
OK167R	10.5 x 19.5	75 mm

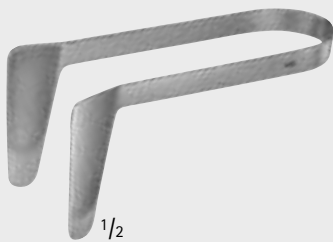
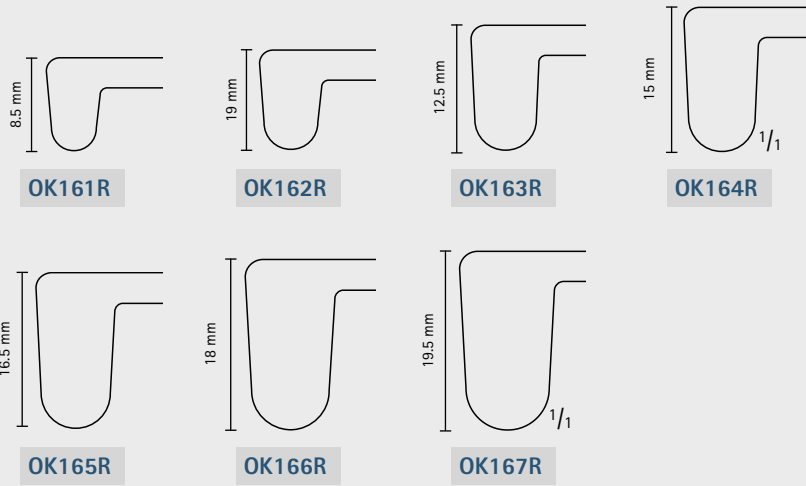

ST CLAIR THOMPSON

OK070R-OK073R

75 mm, 3"

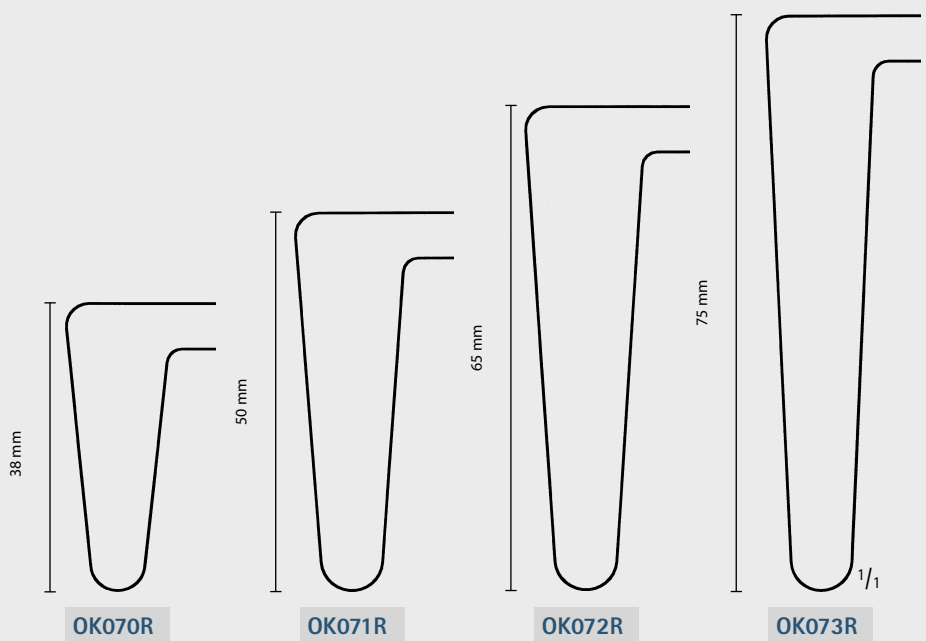



# FESS, Rhinology, Rhinoplasty – FESS, Rhinologie, Septum- und Nasenplastik

## Nasal Specula

## Nasenspekula

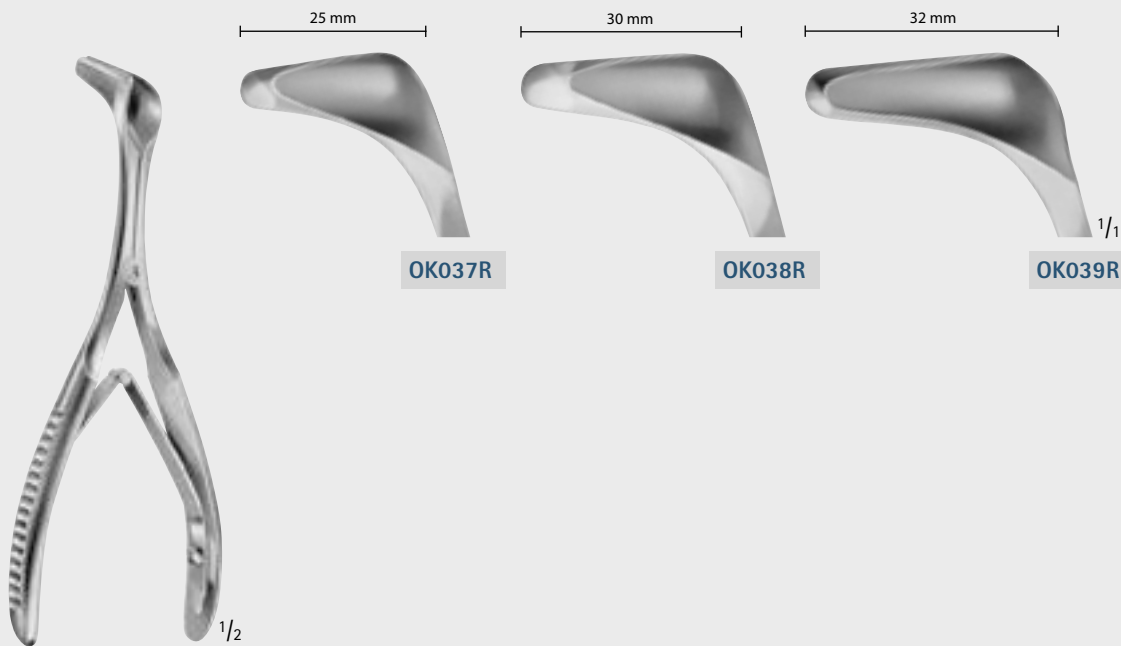

HARTMANN-HALLE

**OK037R-OK039R**

aseptic joint  
mit Steckschluss  
155 mm, 6 1/8"

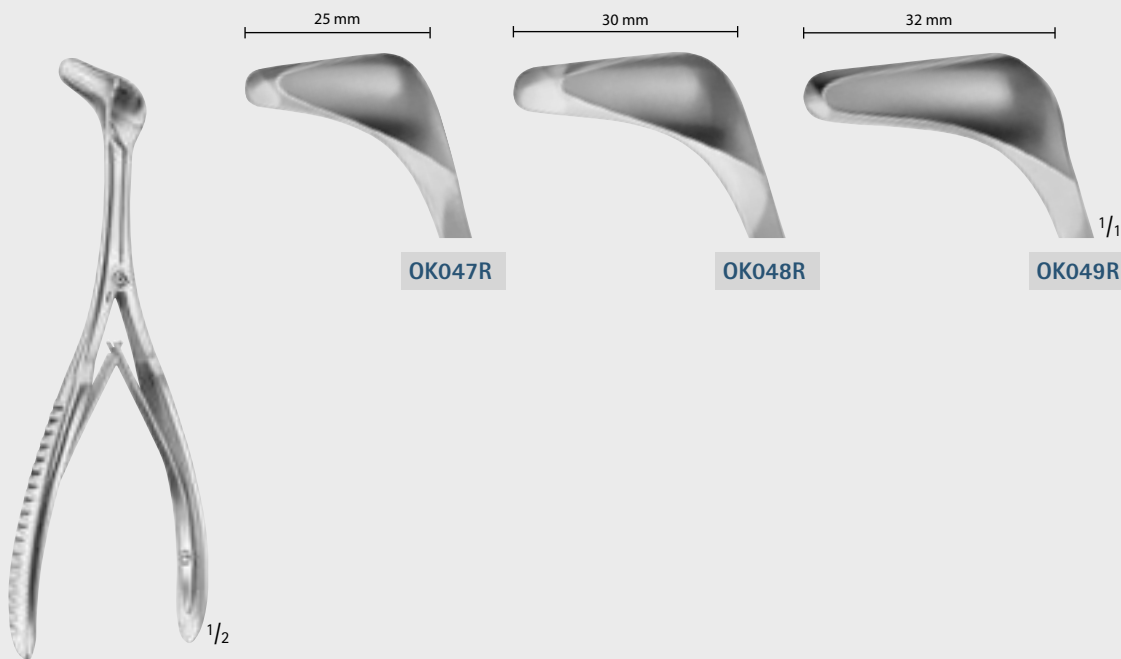

HARTMANN-HALLE

**OK047R-OK049R**

screw joint  
mit Schraubschluss  
155 mm, 6 1/8"

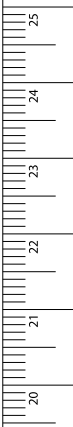

Rhinology  
Rhinologie



MILLIMETERS

# FESS, Rhinology, Rhinoplasty – FESS, Rhinologie, Septum- und Nasenplastik

## Nasal Specula

### Nasenspekula

Rhinology  
Rhinologie



**TIECK-HALLE**  
**OK051R-OK052R**  
screw joint, for use in infants,  
curved sidwards  
mit Schraubschluss, Kindermodell,  
seitwärts gebogen  
135 mm, 5 1/4"

**BECKMANN**  
**OK053R**  
screw joint, for use in infants,  
curved sidwards  
mit Schraubschluss, Kindermodell,  
seitwärts gebogen  
140 mm, 5 1/2"

**BECKMANN**  
**OK058R**  
screw joint, curved sidwards  
mit Schraubschluss,  
seitwärts gebogen  
150 mm, 6"

FESS, Rhinology, Rhinoplasty – FESS, Rhinologie, Septum- und Nasenplastik

Nasal Specula

Nasenspekula

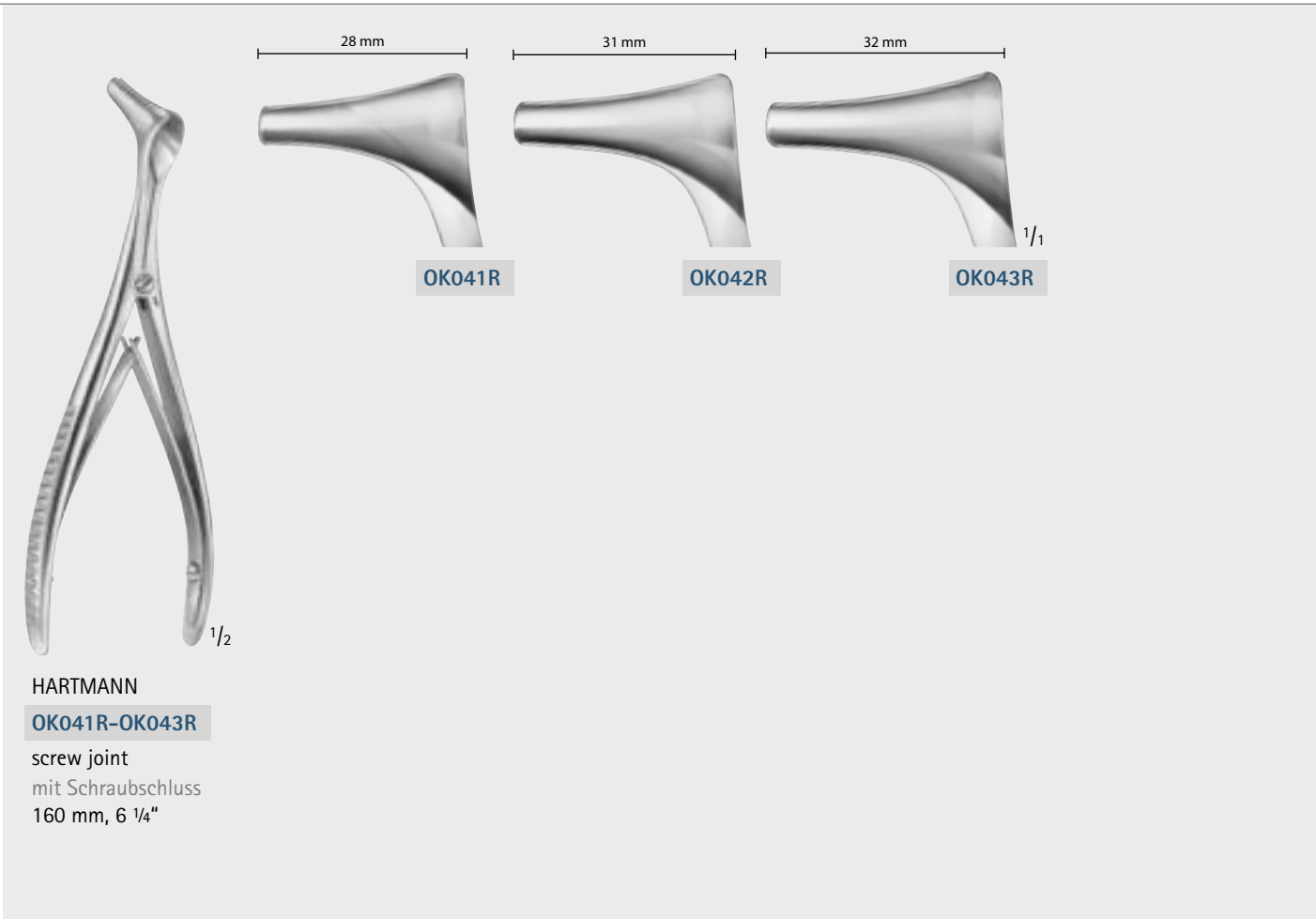

HARTMANN

**OK041R-OK043R**

screw joint  
mit Schraubschluss  
160 mm, 6 1/4"

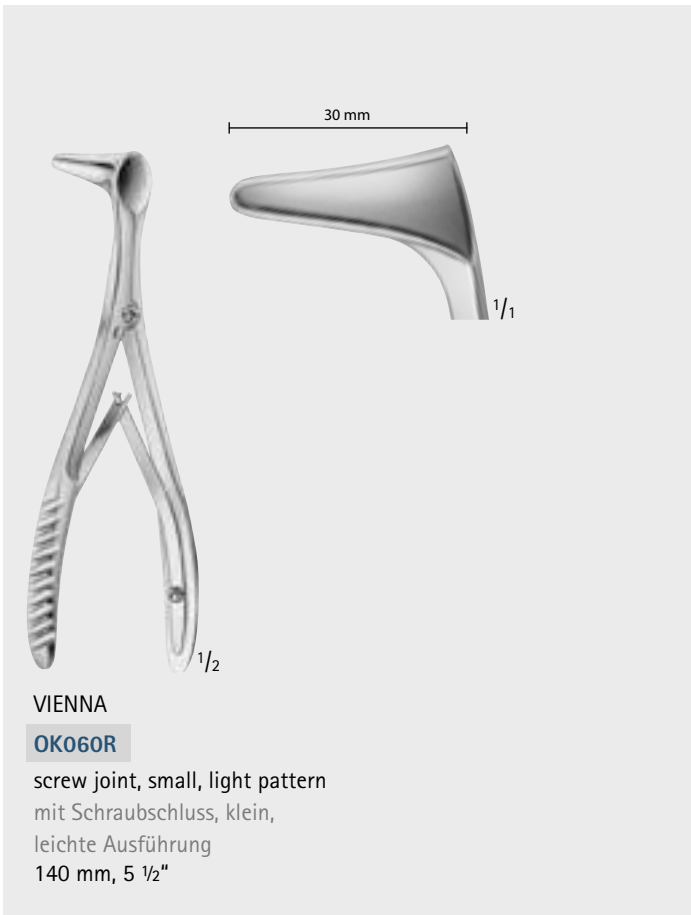

VIENNA

**OK060R**

screw joint, small, light pattern  
mit Schraubschluss, klein,  
leichte Ausführung  
140 mm, 5 1/2"

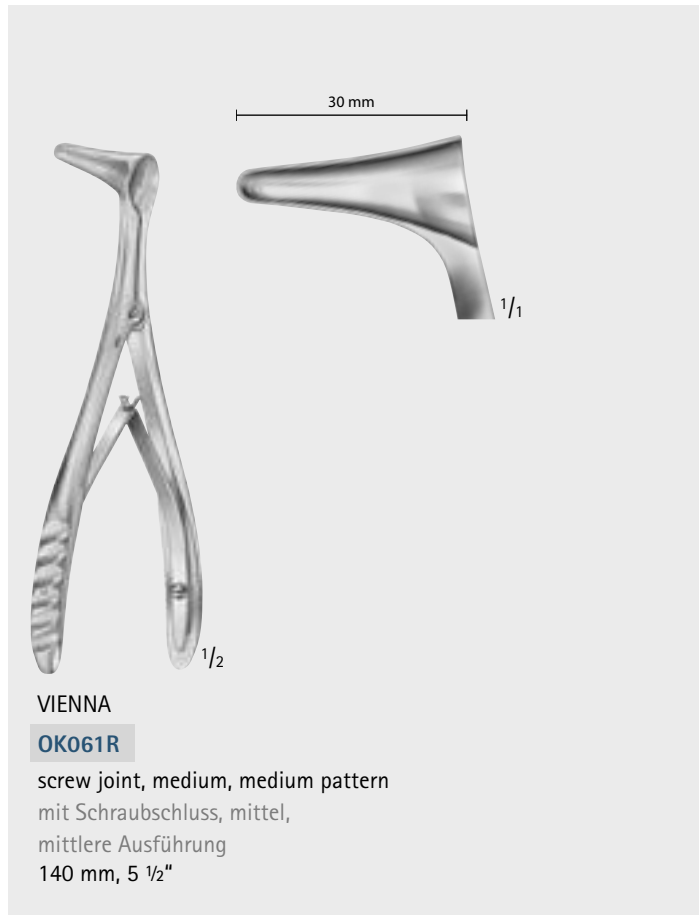

VIENNA

**OK061R**

screw joint, medium, medium pattern  
mit Schraubschluss, mittel,  
mittlere Ausführung  
140 mm, 5 1/2"

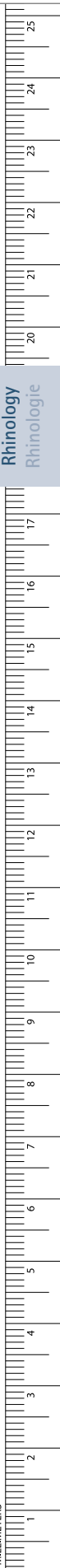

# FESS, Rhinology, Rhinoplasty – FESS, Rhinologie, Septum- und Nasenplastik

## Nasal Specula

### Nasenspekula



Rhinology  
Rhinologie

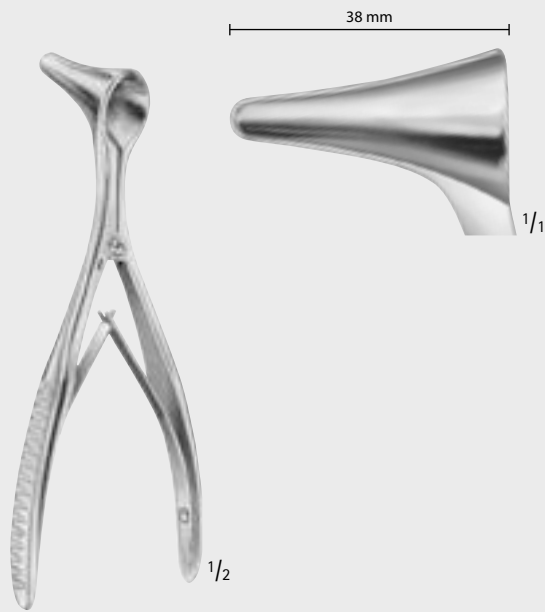

VIENNA

**OK062R**

screw joint, large, heavy  
pattern

mit Schraubschluss, groß,  
schwere Ausführung

140 mm, 5 1/2"



HARTMANN

**OK030R**

light pattern

leichtes Modell

145 mm, 5 3/4"

# FESS, Rhinology, Rhinoplasty – FESS, Rhinologie, Septum- und Nasenplastik

## Nasal Specula

## Nasenspekula

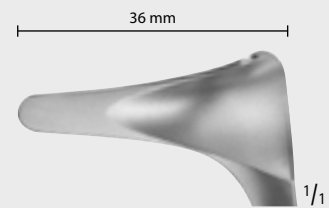

**OK081R, OK091R**

Fig. 1

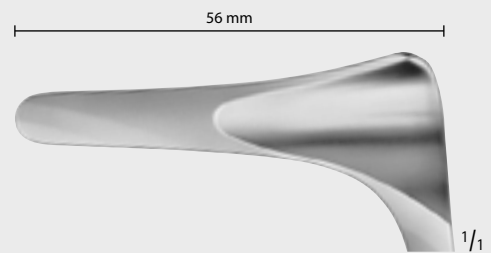

**OK082R, OK092R**

Fig. 2

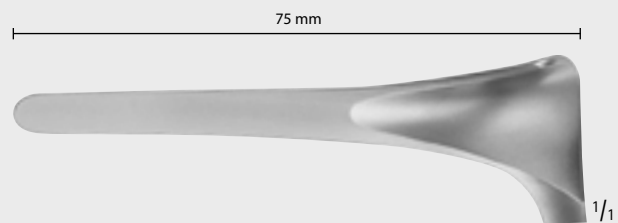

**OK083R, OK093R**

Fig. 3

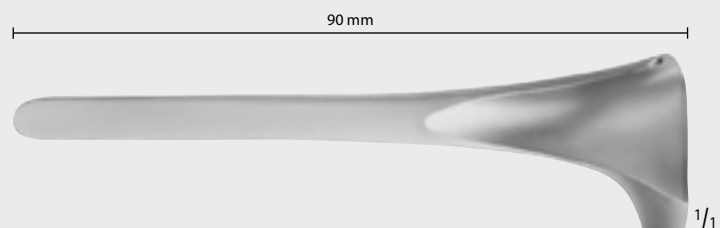

**OK084R, OK094R**

Fig. 4



**KILLIAN**

**OK081R-OK084R**

aseptic joint  
mit Steckschluss  
140 mm, 5 1/2"



**KILLIAN**

**OK091R-OK094R**

screw joint  
mit Schraubschluss  
145 mm, 5 3/4"

# FESS, Rhinology, Rhinoplasty – FESS, Rhinologie, Septum- und Nasenplastik

## Nasal Specula

### Nasenspekula



Rhinology  
Rhinologie

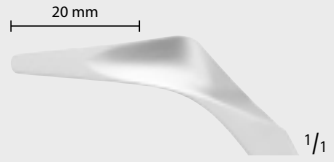

**OK105R**

Fig. 1

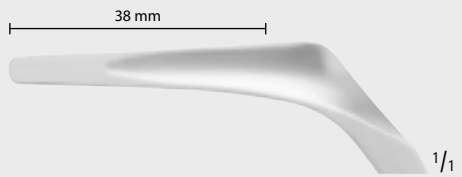

**OK106R**

Fig. 2

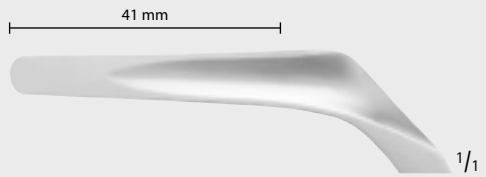

**OK107R**

Fig. 3



**OK108R**

Fig. 4

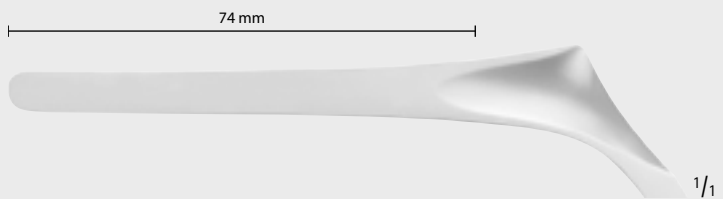

**OK090R**

Fig. 5



**COTTLE**

**OK090R-OK108R**

aseptic joint and set-screw,  
with extra thin blades  
mit Steckschluss und Stellschraube,  
mit besonders schlanken Blättern  
135 mm, 5 1/4"

# FESS, Rhinology, Rhinoplasty – FESS, Rhinologie, Septum- und Nasenplastik

## Nasal Specula

## Nasenspekula

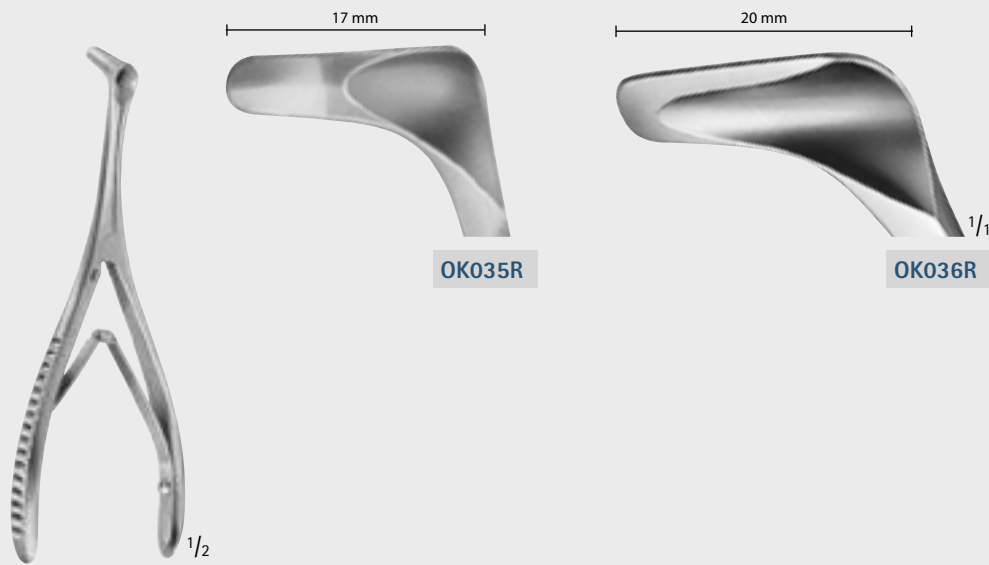

TIECK-HALLE

**OK035R-OK036R**

aseptic joint, for use in infants  
mit Steckschluss, Kindermodelle  
135 mm, 5 1/4"

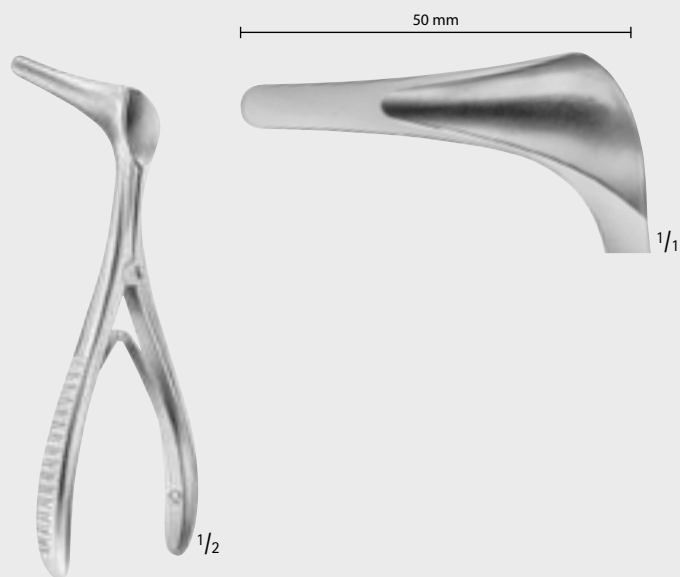

COTTLE

**OK085R**

slightly tapered blades  
leicht spitz zulaufend  
135 mm, 5 1/4"

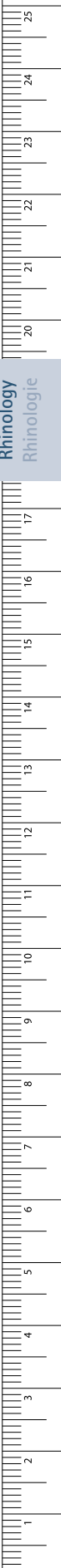

Rhinology  
Rhinologie

# FESS, Rhinology, Rhinoplasty – FESS, Rhinologie, Septum- und Nasenplastik

## Nasal Specula, Light Guide Cables, Adapter

### Nasenspekula, Lichtleitkabel, Adapter

Rhinology  
Rhinologie

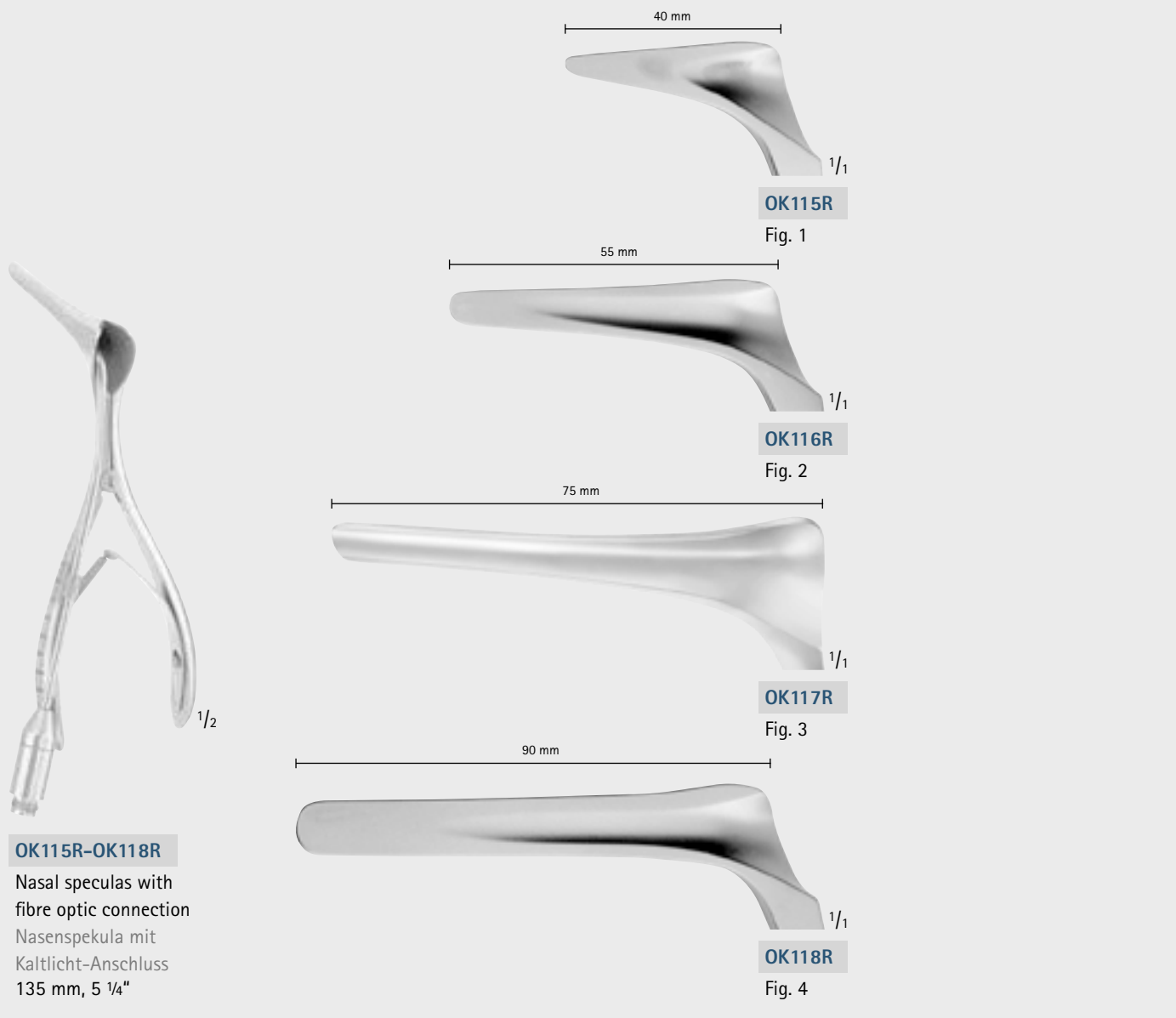

**OK115R-OK118R**  
Nasal speculas with fibre optic connection  
Nasenspekula mit Kaltlicht-Anschluss  
135 mm, 5 1/4"

**OK115R**

Fig. 1

**OK116R**

Fig. 2

**OK117R**

Fig. 3

**OK118R**

Fig. 4

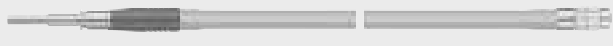

Art. No. Art. Nr.	Description Beschreibung	Length (cm) Länge (cm)
OP923	Full HD light guide cable Full HD Lichtleitkabel	250
OP906		180
OP913		250
OP914		350

Light guide cables, autoclavable, diam. 4.8 mm  
Lichtleitkabel, autoklavierbar, Ø 4,8 mm



Art. No. Art. Nr.	Description Beschreibung
TE683R	Olympus
TE684R	Wolf
TE688R	Olympus-Xenon

Light guide cables adapter for light source of other manufacturers  
Lichtleitkabel-Adapter für Lichtquelle anderer Hersteller

- For suitable Aesculap light sources see brochure no. C46702
- Passende Aesculap Lichtquellen finden Sie im Prospekt C46701



FESS, Rhinology, Rhinoplasty – FESS, Rhinologie, Septum- und Nasenplastik

Nasal Specula

Nasenspekula

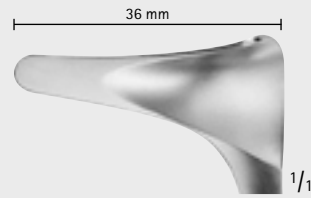

**OK076R**

Fig. 1

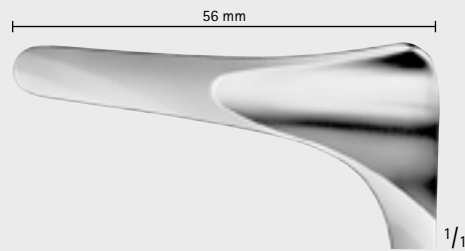

**OK077R**

Fig. 2

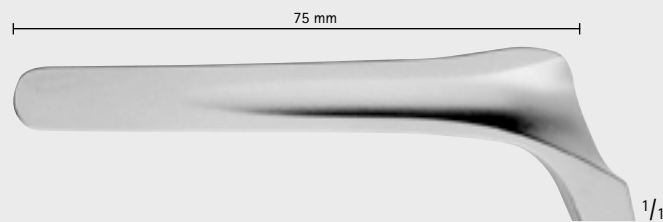

**OK078R**

Fig. 4



**OK076R-OK078R**

with connection to Aesculap® Unitrac®  
 retraction and holding arm  
 mit Adapter für Aesculap® Unitrac®  
 Retraktions- und Haltearm  
 145 mm, 5 3/4"

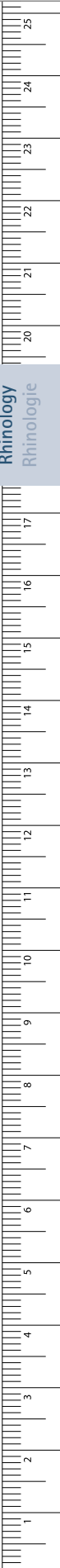

# FESS, Rhinology, Rhinoplasty – FESS, Rhinologie, Septum- und Nasenplastik

Unitrac®

Unitrac®

Rhinology  
Rhinologie



### RT040R

#### Unitrac® – Pneumatic Holding Arm

- Single handed use
- Full range of accessories / adapters for connecting Aesculap endoscopes, trocars and instruments
- Integrated safety systems prevent collapse of holding arm if OR compressed air supply is interrupted
- Direct connection to OR compressed air supply or to CO<sub>2</sub> cartridge
- Diameter of fixation bar: 20 mm
- To be used with JG901

#### Unitrac® – Pneumatischer Haltearm

- Einhand-Bedienung
- Umfangreiches Zubehör und Adapter für Aesculap Endoskope, Trokare und Instrumente
- Integrierte Sicherheitssysteme verhindern ein Kollabieren des Haltearms bei möglichem Ausfall der OP-Druckluftversorgung
- Direkter Anschluss an die vorhandene OP-Druckluftversorgung oder die CO<sub>2</sub> Druckluft-Kartusche
- Durchmesser der Haltestange: 20 mm
- Zu verwenden mit JG901



### RT043R

CO<sub>2</sub> air cartridge adapter for use of Unitrac®, independent from compressed air sources  
CO<sub>2</sub> Kartuschenadapter für den Einsatz des Unitrac®, unabhängig von einem Druckluftanschluss



### RT044SU

Unitrac® CO<sub>2</sub> air cartridge  
Sales unit:  
PAK = Package of 10 pieces, Single Use  
Unitrac® CO<sub>2</sub> Druckluftkartusche  
Bestelleinheit:  
PAK = Packung à 10 Stück, Single Use

#### Unitrac® Air Cartridge: the hose-less „Plug and Play“ solution for Unitrac®

- No need for laying hoses
  - Avoid tripping hazard in the OR
  - Always constant working pressure
  - Overload valve secured
  - Fast and easy change of cartridges
- Die Schlauchlose „Plug and Play“ Lösung für Unitrac®
- Einsatz des Unitrac® unabhängig von einem Druckluftanschluss
  - Vermeidet dadurch Stolperfallen im Operationssaal
  - Gewährt konstanten Betriebsdruck
  - Sicher durch Überdruckventil
  - Schneller und einfacher Kartuschenwechsel



### RT090R

Flexible fixing element with sprocket, suitable for RT040R and FF168R  
Flexible Verbindungsklemme zur OP-Schiene, passend für RT040R und FF168R

1/1

# FESS, Rhinology, Rhinoplasty – FESS, Rhinologie, Septum- und Nasenplastik

Unitrac®  
Unitrac®



### JG901

Sterile drape for coverage of the Unitrac® arms, Single Use  
Sales unit:

**PAK** = Package of 50 pieces

Steriler Überzug für den Unitrac® Haltearm, Einmalgebrauch  
Bestelleinheit:

**PAK** = Packung à 50 Stück



### RT020R

Quick connect adapter for use with sterile drape JG901.  
Allows the change of instruments after draping with  
JG901

Schnellverschluss Adapter für die Verwendung mit  
dem Sterilüberzug JG901. Ermöglicht den Instrumenten-  
wechsel nach dem Abdecken mit JG901



Unitrac® in combination with MINOP® TREND  
Unitrac® in Verbindung mit MINOP® TREND

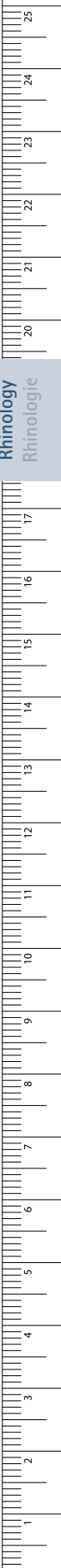

- For further endoscopes and endo units see brochure no.C47411
- Weitere Endoskope und Endoskopie-Einheiten finden Sie im Prospekt C47411

## FESS, Rhinology, Rhinoplasty – FESS, Rhinologie, Septum- und Nasenplastik

### M-TRAC – Mechanical Holding Arm

### M-TRAC – Mechanischer Haltearm



#### FF168R

M-TRAC® – Flexible holding device with mechanical fixation

- Total length: 107 cm
- Length of fixation bar: 46 cm
- Diameter of fixation bar: 20 mm
- Total weight: 0.7 kg
- Holding force: 4 kg
- Easy mechanical fixation by clamping handle
- Small, flexible joints for fine positioning
- Autoclavable 134°C, 5 minutes
- Full range of accessories/adapters for connecting Aesculap endoscopes, trocars and instruments
- Holding arm fits into regular Standard 1/1 Container, see brochure no. C40402

M-TRAC® – Flexibles Haltesystem mit mechanischer Fixierung

- Gesamtlänge: 107 cm
- Länge der Haltestange: 46 cm
- Durchmesser der Haltestange: 20 mm
- Gesamtgewicht: 0,7 kg
- Haltekraft: 4 kg
- Einfache mechanische Fixierung über Spanngriff
- Kleine, flexible Gelenke für Feinpositionierung
- Autoklavierbar 134°C, 5 Minuten
- Umfangreiches Zubehör und Adapter für Aesculap Endoskope, Trokare und Instrumente
- Haltearm passt in einen Standard 1/1 Container, siehe Prospekt Nr. C40401



#### FF280R

Flexible fixing element with ball joint, suitable for and FF168R

Flexible Verbindungsklemme mit Kugelgelenk, passend für FF168R

# FESS, Rhinology, Rhinoplasty – FESS, Rhinologie, Septum- und Nasenplastik

MINOP® TREND

MINOP® TREND



Rhinology  
Rhinologie



**FH615**

Handle with irrigation button for FH610R and FH611R. Ergonomic grasping part  
Handgriff mit Spülknopf für FH610R und FH611R. Ergonomischer Handgriff



**RT099R**

Adapter for Aesculap holding arm and FH615  
Adapter für Aesculap Haltearm und FH615



**FH605SU**

Suction and irrigation tube, sterile, 4.5 m with 2 puncture needles for handle FH615 and FH610R/FH611R  
Sales unit: PAK = Package of 10 tubes  
Spül-/Saugschlauch, steril, 4,5 m, mit 2 Punk-  
tionskanülen für Griff FH615 und FH610R/FH611R  
Bestelleinheit: PAK = Packung à 10 Schlauchsets

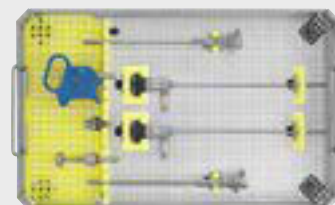

**FF357R** 410 x 257 x 64 mm

Storage tray with silicone padding and lid for all MINOP® TREND components (without instruments)  
Lagerungstray mit Silikon-Lagerungsstegen und Deckel für alle MINOP® TREND Komponenten (ohne Inhalt)

- For further informations about storage trays and containers please see brochure No. C40402
- Weitere Informationen über Lagerungstray und Container siehe Broschüre Nr. C40401

MILLIMETERS

## FESS, Rhinology, Rhinoplasty – FESS, Rhinologie, Septum- und Nasenplastik

### Suction and Irrigation Trocars, Endoscopes

### Saug- und Spültrocare, Endoskope

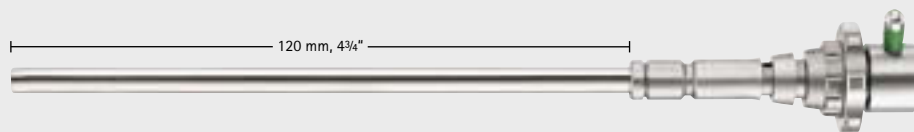

#### FH610R

Suction and irrigation trocar for 0° endoscope PE487A,  
diam. 4.5 / 6.0 mm

Spül-/Saugtrokar für 0°-Endoskop PE487A,  
Ø 4,5 / 6,0 mm



#### FH611R

Suction and irrigation trocar for 30° endoscope PE507A,  
diam. 4.5 mm / 6.0 mm

Spül-/Saugtrokar für 30°-Endoskop PE507A,  
Ø 4,5 mm / 6,0 mm

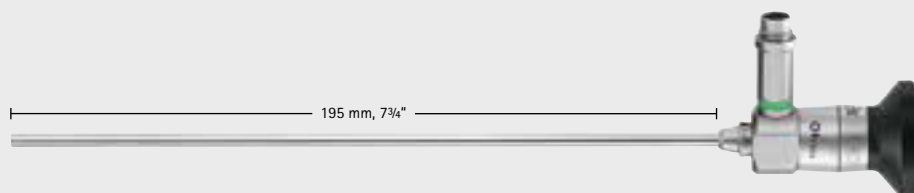

#### PE487A

Endoscope

Direction of view: 0° (green ring)

Shaft diam. 4.0 mm

autoclavable

Endoskop

Blickrichtung: 0° (grüner Ring),

Schaft-Ø: 4.0 mm

autoklavierbar

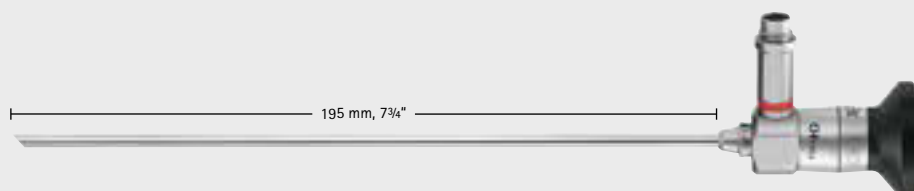

#### PE507A

Endoscope

Direction of view: 30° (red ring),

Shaft diam. 4.0 mm

autoclavable

Blickrichtung: 30° (roter Ring)

Schaft-Ø: 4.0 mm

autoklavierbar

- For further endoscopes and endo units see brochure no. C46702
- Weitere Endoskope und Endoskopie-Einheiten finden Sie im Prospekt Nr. C46701

# FESS, Rhinology, Rhinoplasty – FESS, Rhinologie, Septum- und Nasenplastik

## Nasal Scissors, Micro Scissors

### Nasenscheren, Mikro-Schere



- The LUER-Lock flushing ports of tubular shaft instruments allow easy cleaning of the instruments as well as lubrication with a steam permeable oil (e.g. Aesculap Sterilit®).
- Die LUER-Lock Spülanschlüsse bei Rohrschaft-Instrumenten ermöglichen eine einfache Reinigung der Instrumente, sowie die Pflege mit einem dampfdurchlässigen Öl (z.B. Aesculap Sterilit®).



Rhinology  
Rhinologie



MILLIMETERS

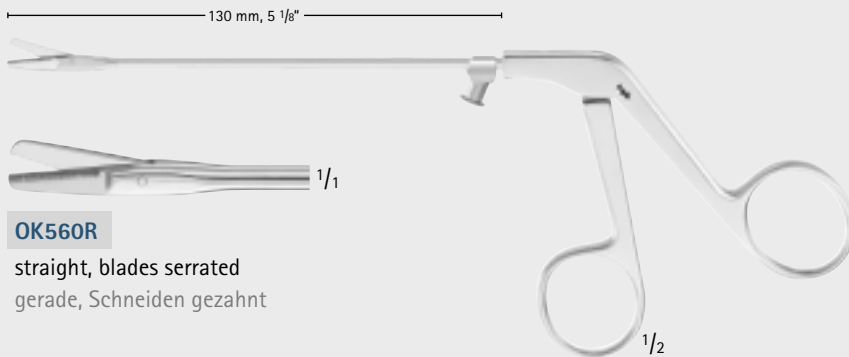

**OK560R**

straight, blades serrated  
gerade, Schneiden gezahnt



**OK561R**

left curved, blades serrated  
links gebogen, Schneiden gezahnt



**OK562R**

right curved, blades serrated  
rechts gebogen, Schneiden gezahnt

**OK560R-OK562R**

Nasal scissors  
Nasenscheren

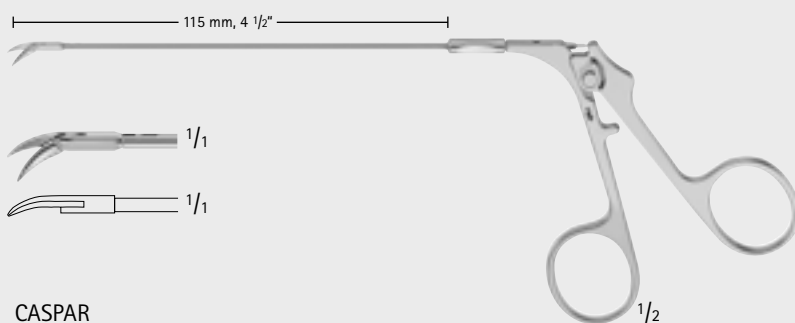

**CASPAR**

**FD228R**

Micro scissors, curved rotates 360°,  
detachable for cleaning  
Mikro-Schere, gebogen, 360° drehbar,  
zerlegbar zur Reinigung

# FESS, Rhinology, Rhinoplasty – FESS, Rhinologie, Septum- und Nasenplastik

## Antrum Punches

### Antrumstanzen

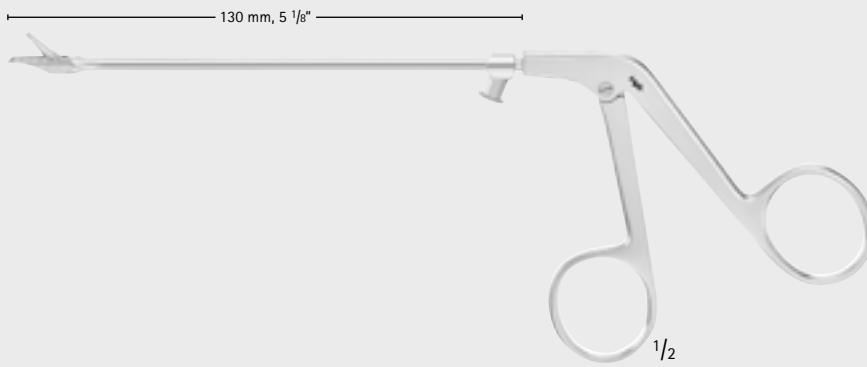
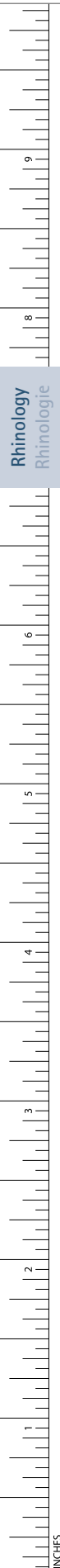

**OK602R-OK609R**

		1/1 6 x 1.5 mm	1/1 8 x 3 mm	1/1 11.5 x 3.5 mm
	straight gerade	<b>OK608R</b> forward through cutting nach vorne durchschneidend	MACKAY-GRUNEWALD <b>OK602R</b> forward through cutting nach vorne durchschneidend	MACKAY-GRUNEWALD <b>OK603R</b> forward through cutting nach vorne durchschneidend
	45° upwards angled 45° nach oben gebogen	<b>OK609R</b> forward through cutting nach vorne durchschneidend	MACKAY-GRUNEWALD <b>OK606R</b> forward through cutting nach vorne durchschneidend	MACKAY-GRUNEWALD <b>OK607R</b> forward through cutting nach vorne durchschneidend

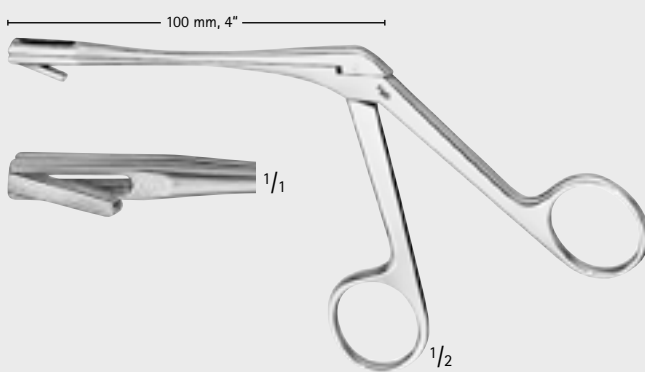

**OSTROM**

**OK704R**

reverse action jaw  
rückwärts schneidend



# FESS, Rhinology, Rhinoplasty – FESS, Rhinologie, Septum- und Nasenplastik

## Antrum Punches

### Antrumstanzen

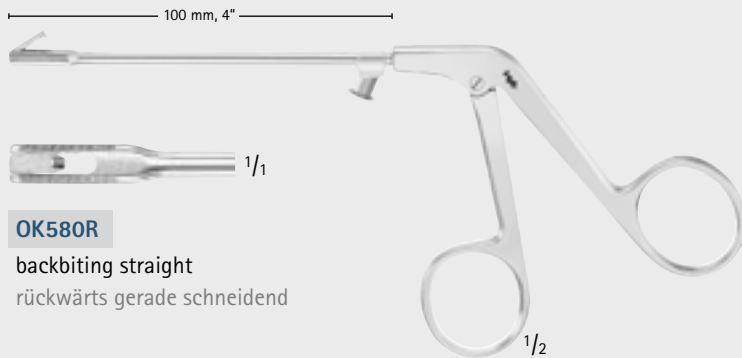

**OK580R**

backbiting straight  
rückwärts gerade schneidend



**OK581R**

backbiting to the right  
rückwärts nach rechts schneidend



**OK582R**

backbiting to the left  
rückwärts nach links schneidend

STAMMBERGER

**OK580R-OK582R**

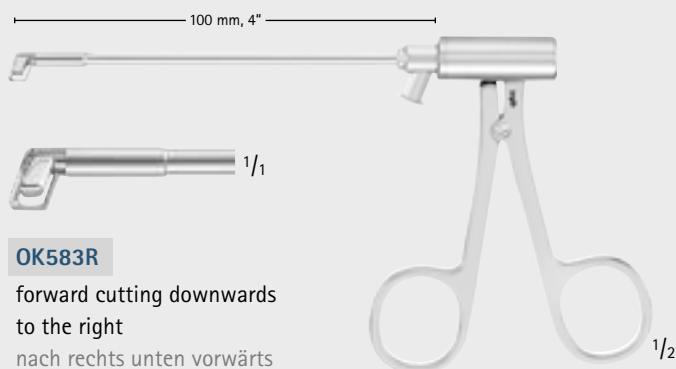

**OK583R**

forward cutting downwards  
to the right  
nach rechts unten vorwärts  
schneidend



**OK584R**

forward cutting downwards  
to the left  
nach links unten vorwärts  
schneidend

STAMMBERGER

**OK583R-OK584R**

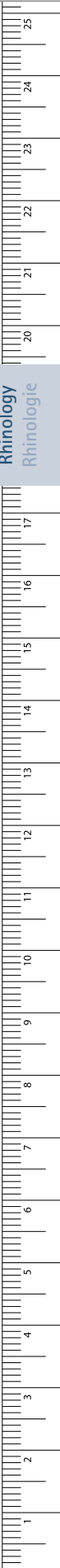

# FESS, Rhinology, Rhinoplasty – FESS, Rhinologie, Septum- und Nasenplastik

## Giraffe Forceps

### Giraffenzangen

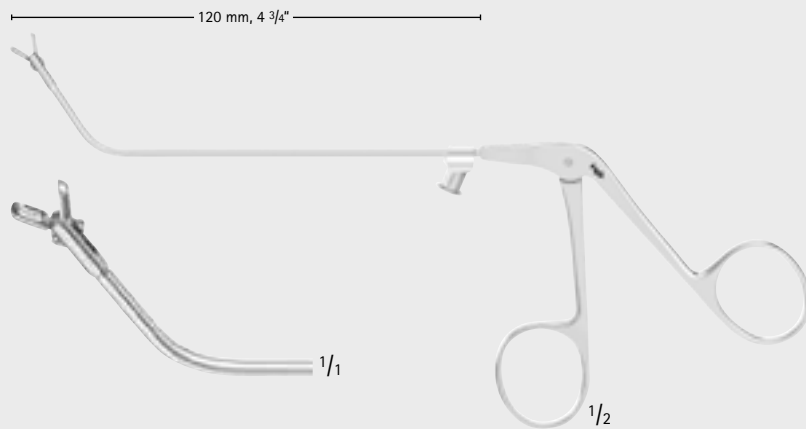

#### OK620R

upwards curved, cup size diam. 3 mm, double action  
aufwärts gebogen, Löffelgröße Ø 3 mm, doppel beweglich

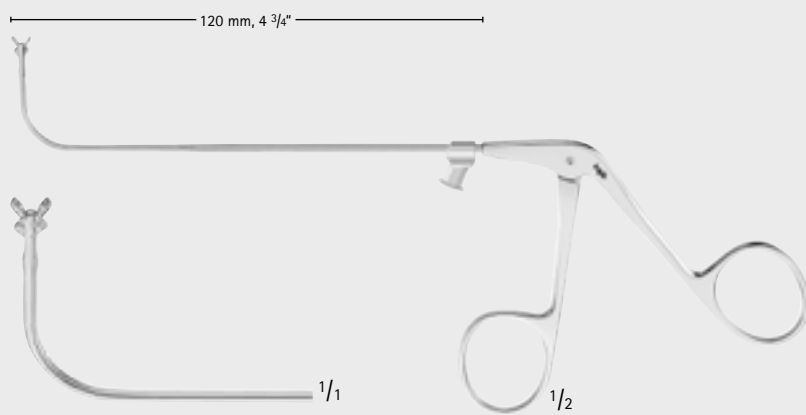

#### OK621R

strongly upwards curved, cup size diam. 2 mm, double action  
stark aufwärts gebogen, Löffelgröße Ø 2 mm, doppel beweglich

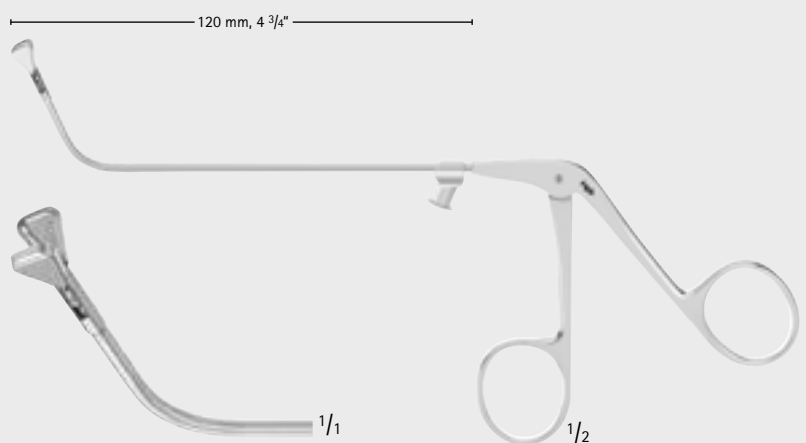

#### OK622R

upwards curved, jaw size 4 x 6 mm, double action  
aufwärts gebogen, Maulgröße 4 x 6 mm, doppel beweglich

# FESS, Rhinology, Rhinoplasty – FESS, Rhinologie, Septum- und Nasenplastik

## Antrum Grasping Forceps

### Antrum Fassungszangen

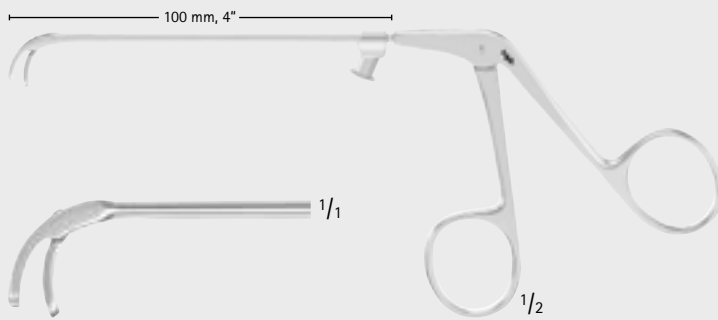

**OK680R**

jaw opening backwards, curved downwards  
rückwärts öffnend, nach unten gebogen

**OK680R-OK683R**



**OK681R**

jaw opening backwards, curved upwards  
rückwärts öffnend, nach oben gebogen



**OK682R**

jaw opening backwards, curved to right  
rückwärts öffnend, nach rechts gebogen

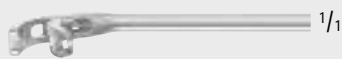

**OK683R**

jaw opening backwards, curved to left  
rückwärts öffnend, nach links gebogen

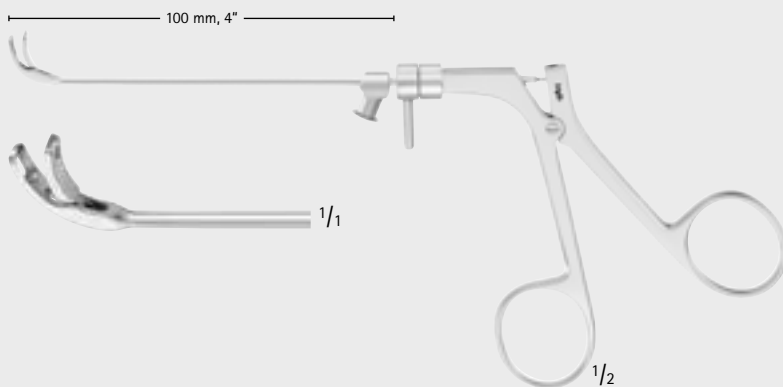

**OK684R**

jaw opening backwards, jaw rotates 360°  
rückwärts öffnend, Maul 360° drehbar

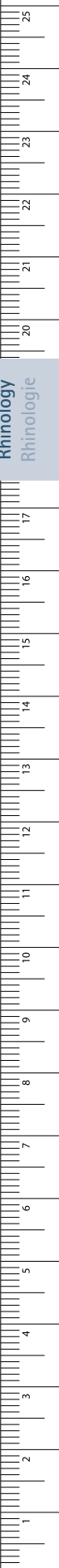

Rhinology  
Rhinologie

MILLIMETERS

# FESS, Rhinology, Rhinoplasty - FESS, Rhinologie, Septum- und Nasenplastik

## Nasal Cutting Forceps

### Conchotome



Rhinology  
Rhinologie

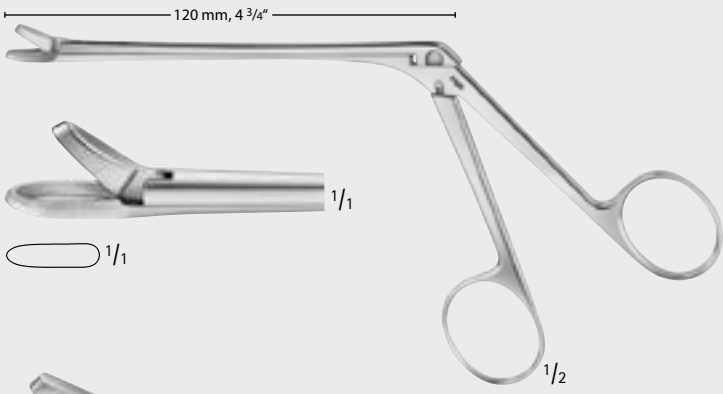

MYLES

**OK600R**

through cutting  
durchschneidend



GRUENWALD-HENKE

**OK612R-OK613R**

through cutting  
durchschneidend

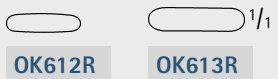

**OK612R**

**OK613R**

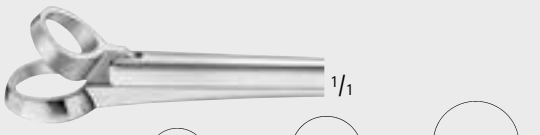

HARTMANN

**OK641R-OK644R**

through cutting  
durchschneidend



**OK641R**

**OK642R**

**OK643R**

**OK644R**



SCHMEDEN

**OK646R-OK647R**

through cutting  
durchschneidend



**OK646R**

**OK647R**



STRUYCKEN

**OK690R**

through cutting  
durchschneidend

# FESS, Rhinology, Rhinoplasty – FESS, Rhinologie, Septum- und Nasenplastik

## Septum Forceps

### Septumzangen

LUC

**OK433R-OK434R**

with fenestrated jaws  
gefenstert  
200 mm, 7 7/8"

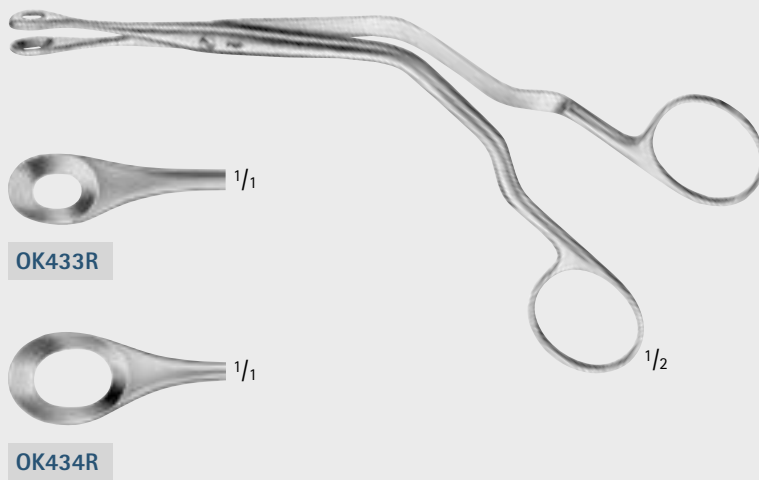

**OK433R**

**OK434R**

LUC

**OK435R-OK436R**

with fenestrated jaws  
gefenstert  
195 mm, 7 3/4"

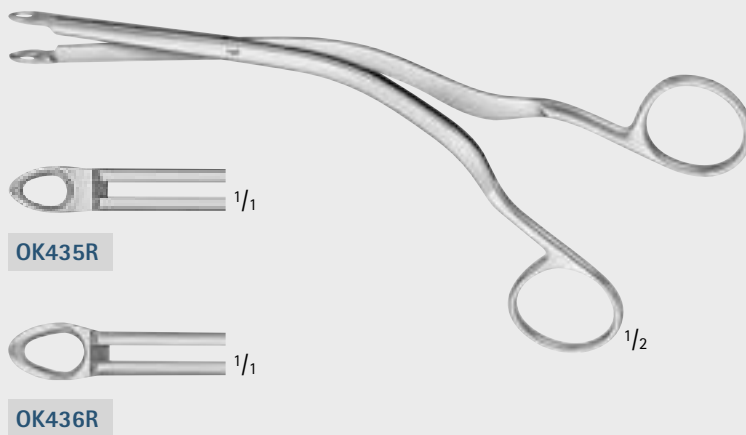

**OK435R**

**OK436R**

BRÜNING'S

**OK440R-OK443R**

190 mm, 7 1/2"

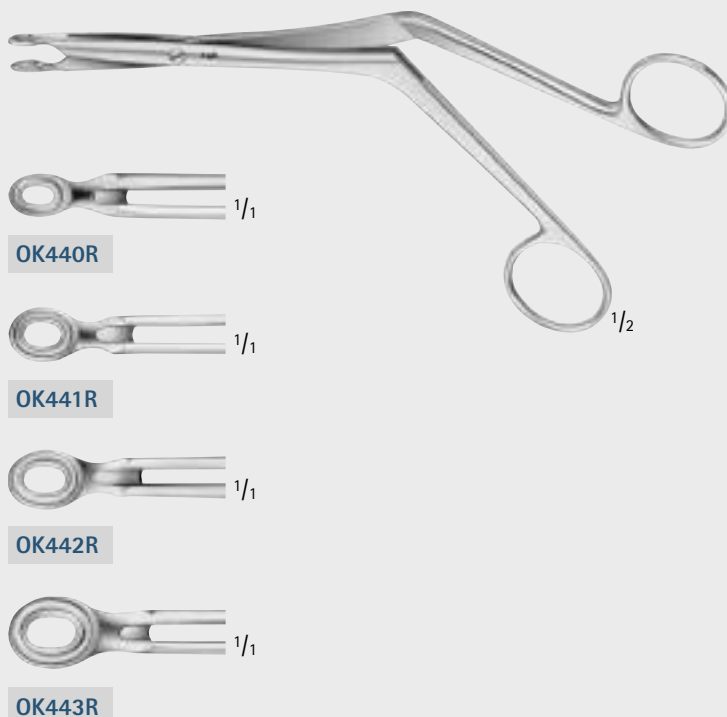

**OK440R**

**OK441R**

**OK442R**

**OK443R**



# FESS, Rhinology, Rhinoplasty - FESS, Rhinologie, Septum- und Nasenplastik

## Rongeurs

## Rongeure

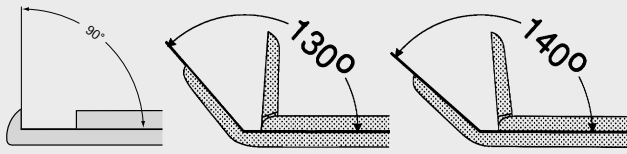

- Angled positions for rongeurs
- Winkelstellungen bei Rongeuren

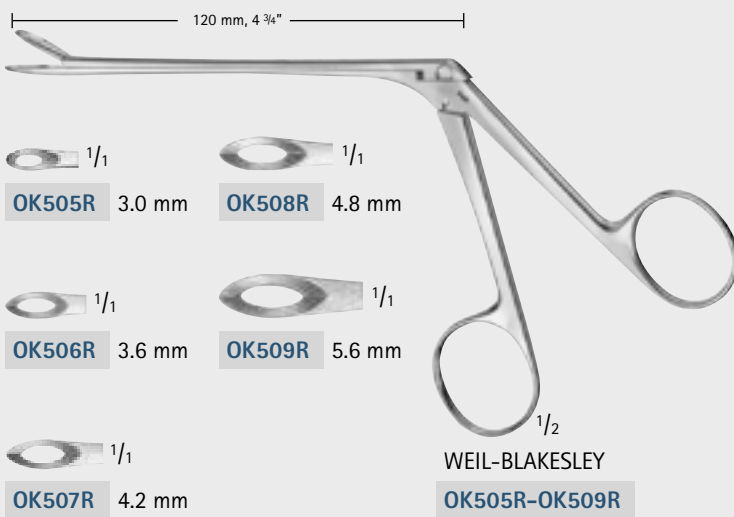

140°  
upwards angled  
aufwärts gewinkelt

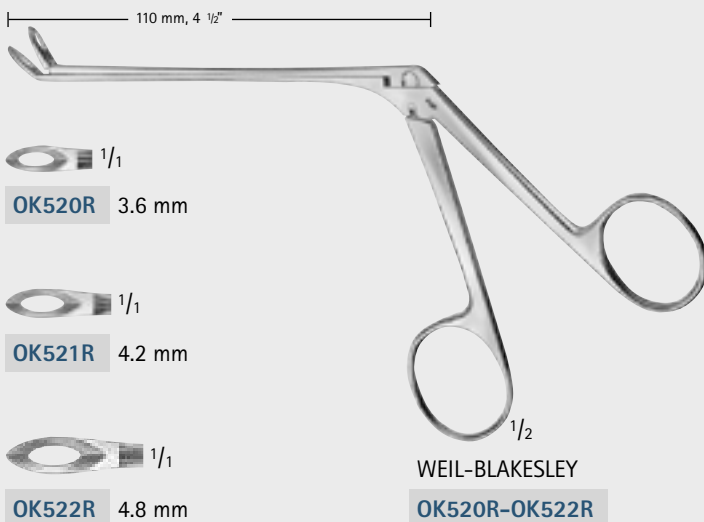

# FESS, Rhinology, Rhinoplasty – FESS, Rhinologie, Septum- und Nasenplastik

Rongeurs

Rongeurs

90°  
upwards angled  
aufwärts gewinkelt

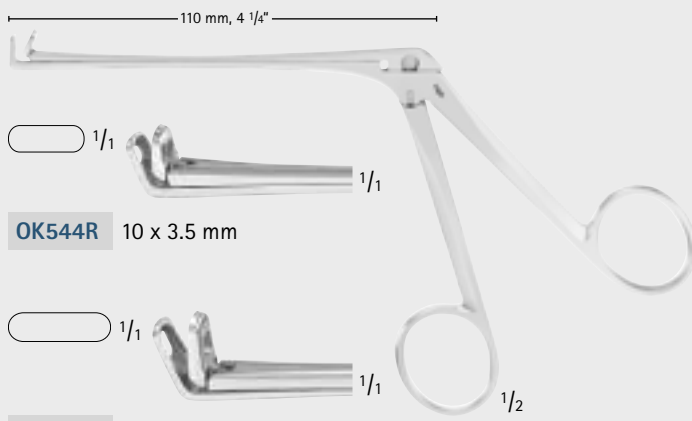

**OK544R** 10 x 3.5 mm

**OK545R** 13.5 x 3.8 mm



**OK546R** 14.3 x 5 mm

BLAKESLEY-WILDE

**OK544R-OK546R**

90°  
upwards angled  
aufwärts gewinkelt

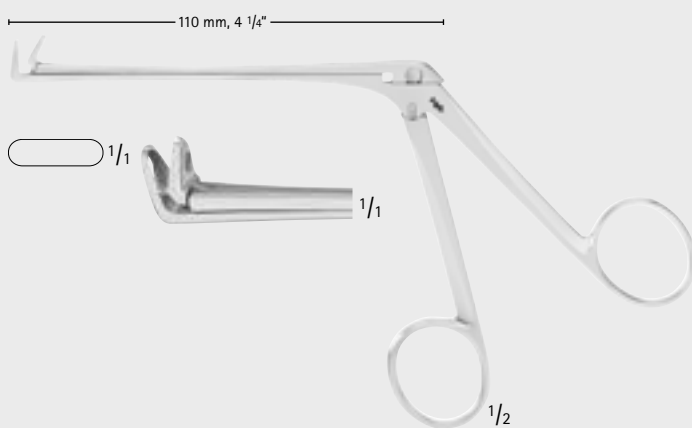

BLAKESLEY-WILDE

**OK547R** 12.5 x 3.5 mm

90° upwards angled, delicate

90° aufwärts gewinkelt, fein

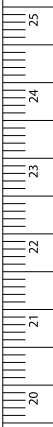

Rhinology  
Rhinologie

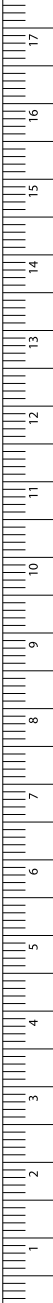

MILLIMETERS

# FESS, Rhinology, Rhinoplasty – FESS, Rhinologie, Septum- und Nasenplastik

Nasal Forceps, Rongeurs

Nasenzangen, Rongeurs

Rhinology  
Rhinologie

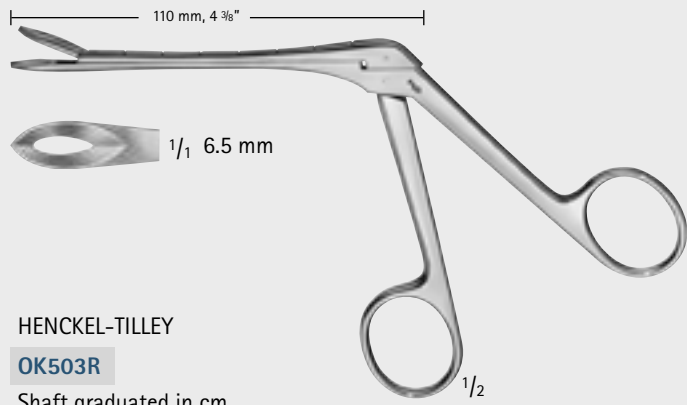

HENCKEL-TILLEY

OK503R

Shaft graduated in cm

Schaft graduiert in cm

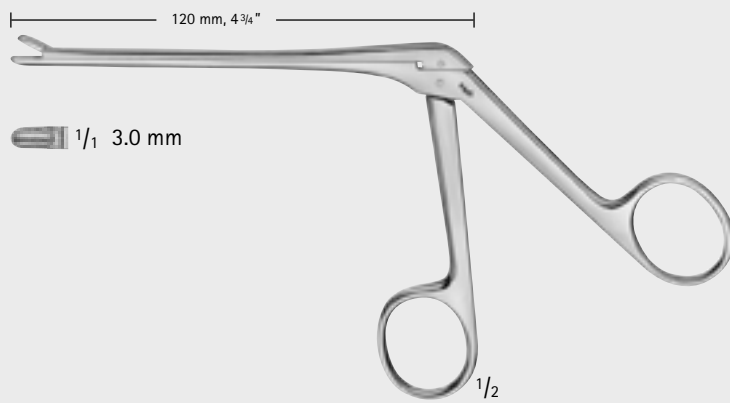

ST. BARTS

OK536R

140°

upwards angled

aufwärts gewinkelt

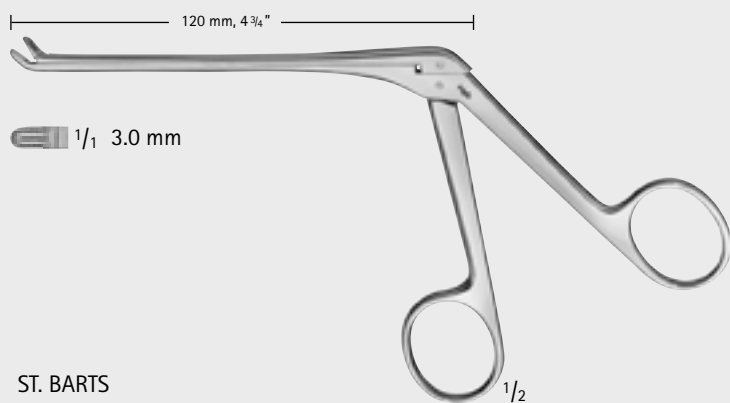

ST. BARTS

OK537R



# FESS, Rhinology, Rhinoplasty – FESS, Rhinologie, Septum- und Nasenplastik

Nasal Forceps, Rongeurs

Nasenzangen, Rongeurs

**140°**  
downbiting  
nach unten schneidend

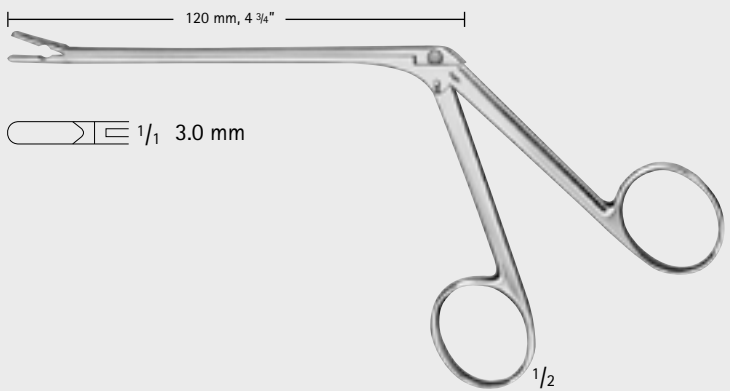
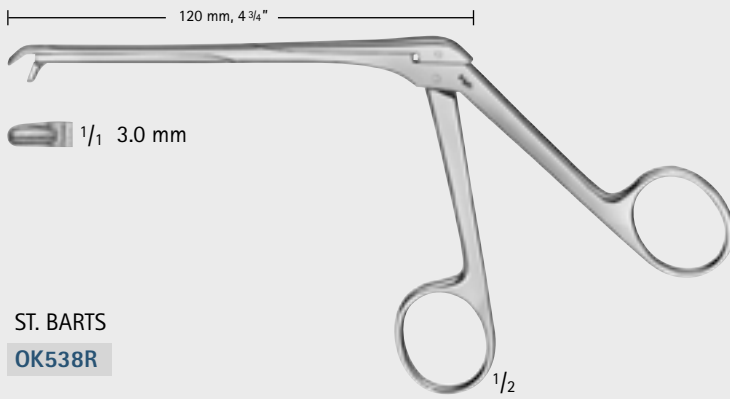

**130°**  
upwards angled  
aufwärts gewinkelt

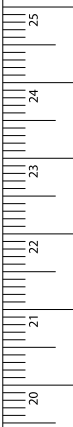
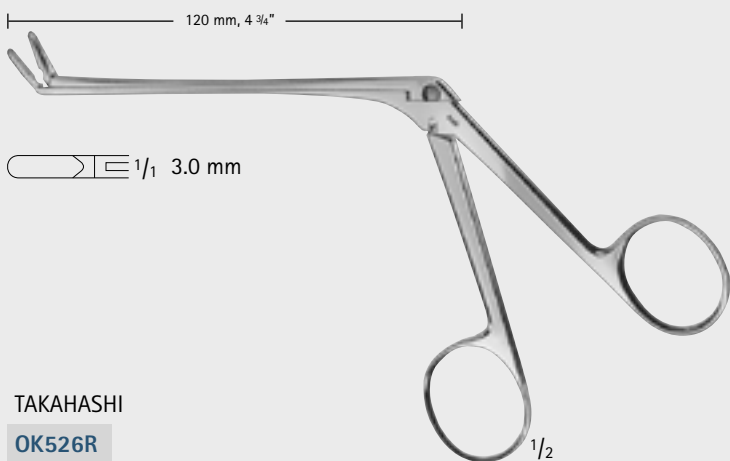

Rhinology  
Rhinologie

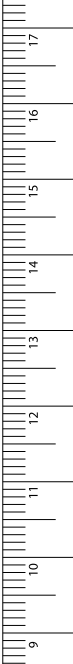

# FESS, Rhinology, Rhinoplasty – FESS, Rhinologie, Septum- und Nasenplastik

## Ethmoidal Forceps

Siebbeinzangen, Fasszange

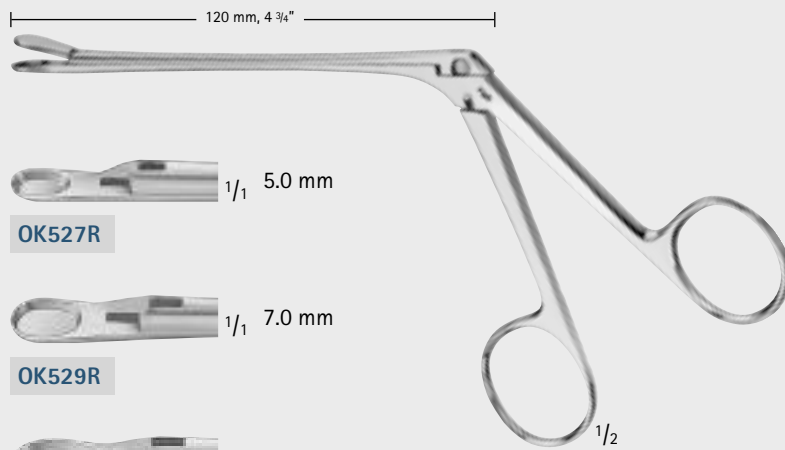
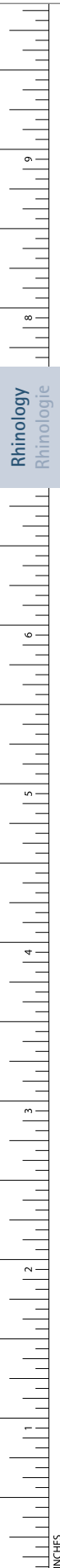

1/1 5.0 mm

**OK527R**

1/1 7.0 mm

**OK529R**

1/1 9.0 mm

**OK531R**

WATSON-WILLIAMS

**OK527R-OK531R**

Ethmoidal forceps

Siebbeinzange

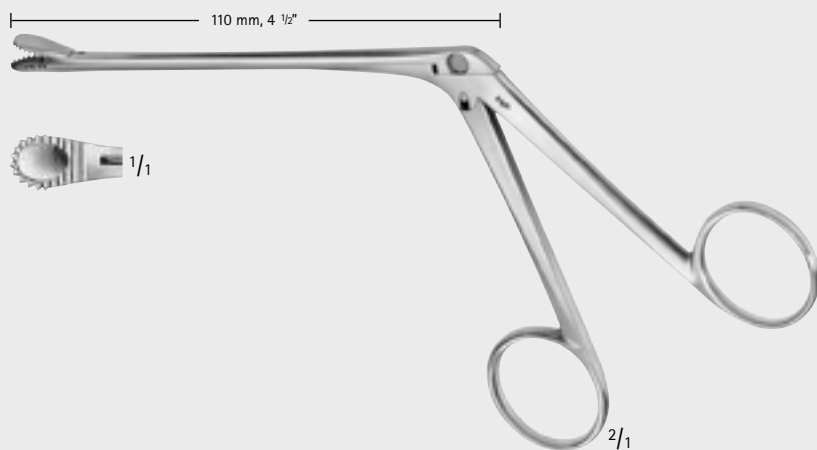

1/1

WATSON-WILLIAMS

**OK530R**

Ethmoidal forceps for mucosa,  
serrated jaws

Fasszange für Schleimhaut,  
gezahnt

# FESS, Rhinology, Rhinoplasty – FESS, Rhinologie, Septum- und Nasenplastik

Sickle Knife, Antrum Curettes, Frontal Sinus Curettes

Sichelmesser, Antrumlöffel, Stirnhöhlenlöffel



**OF601R**  
Sickle knife, sharp tip  
Sichelmesser, spitz  
190 mm, 7 1/2"



**FK650R**  
Antrum curette, oval  
Antrumlöffel, oval  
190 mm, 7 1/2"

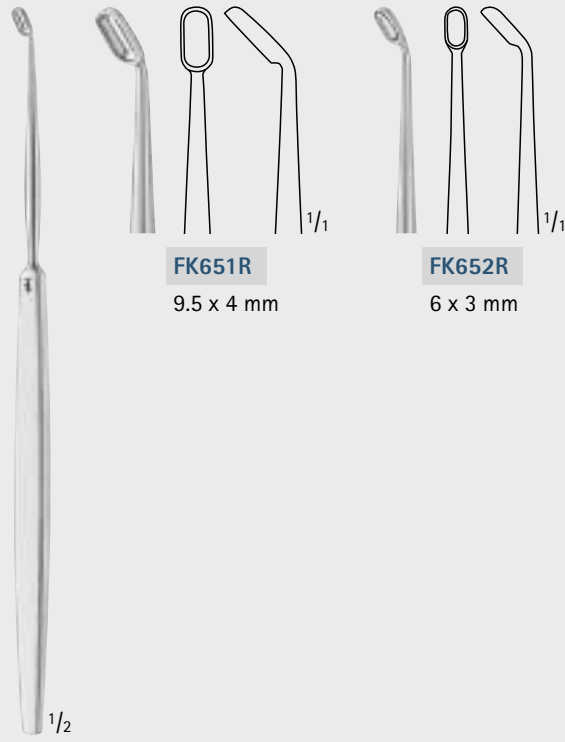

**FK651R**  
9.5 x 4 mm

**FK652R**  
6 x 3 mm

**FK651R-FK652R**  
Antrum curette, oval  
Antrumlöffel, oval  
190 mm, 7 1/2"

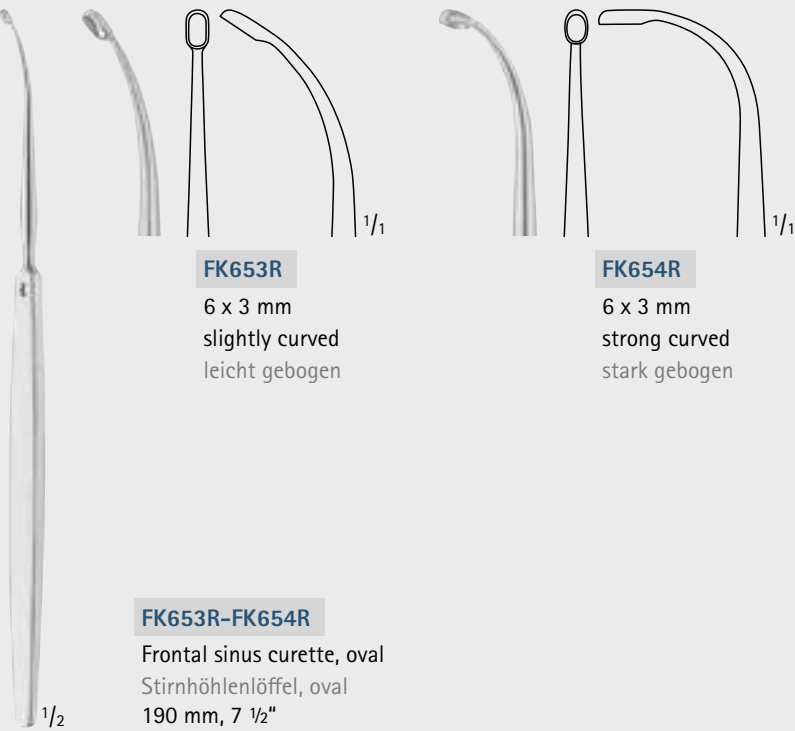

**FK653R**  
6 x 3 mm  
slightly curved  
leicht gebogen

**FK654R**  
6 x 3 mm  
strong curved  
stark gebogen

**FK653R-FK654R**  
Frontal sinus curette, oval  
Stirnhöhlenlöffel, oval  
190 mm, 7 1/2"

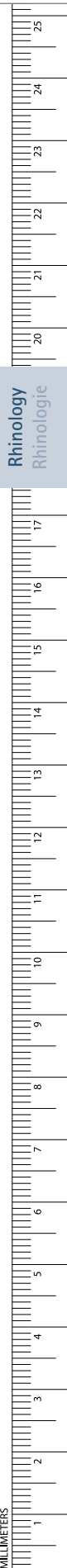

Rhinology  
Rhinologie

- Please find further curettes in chapter bone instruments, starting on page 216
- Weitere Löffel und Küretten, siehe Kapitel Knocheninstrumente, ab Seite 216

# FESS, Rhinology, Rhinoplasty – FESS, Rhinologie, Septum- und Nasenplastik

## Antrum Currettes, Antrum Retractor

Antrumküretten, Antrumahaken



Rhinology  
Rhinologie



OK811R

OK812R

OK813R

OK814R

OK815R

OK816R



COAKLEY

OK811R-OK816R

Antrum currettes

Antrumküretten

170 mm, 6 3/4"

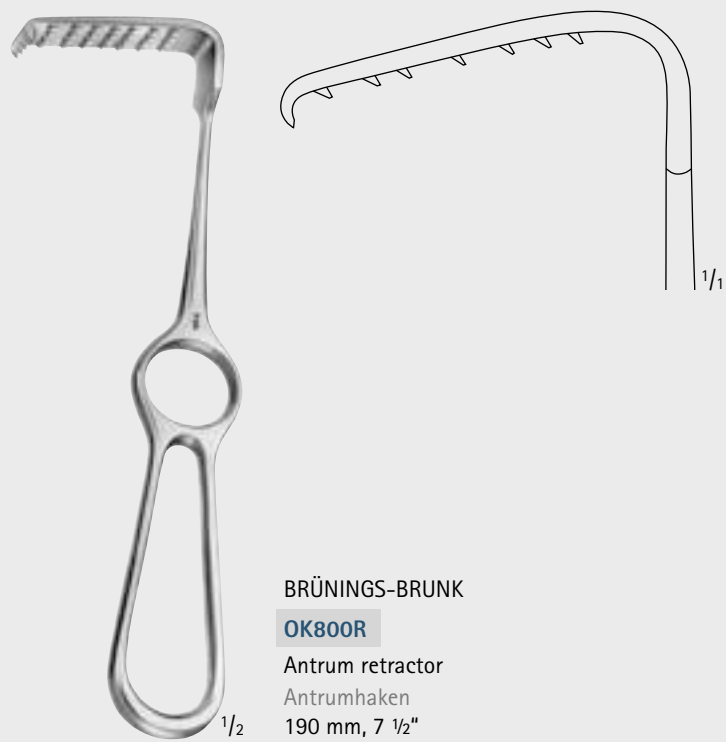

BRÜNINGS-BRUNK

OK800R

Antrum retractor

Antrumahaken

190 mm, 7 1/2"

- Please find further instruments for Neurosurgery in our separate catalog no. C20121
- Weitere Instrumente für die Neurochirurgie, siehe Katalog Nr. C20121

# FESS, Rhinology, Rhinoplasty – FESS, Rhinologie, Septum- und Nasenplastik

## Irrigating Cannulas, Antrum Trocars, Antrum Rasps

### Spülröhrchen, Antrumtrokare, Antrumtrephinen



**EICKEN**

Art. No. Art. Nr.	Diam. (mm) Ø (mm)	Length Länge
<b>OK874C</b>	2.5	130 mm, 5 1/8"
<b>OK875C</b>	3.0	130 mm, 5 1/8"

Irrigating cannula, LUER cone, strong curved, stainless steel  
Spülröhrchen, LUER Konus, stark gebogen, rostfreier Stahl



**EICKEN**

**OK876R**

Irrigating cannula, LUER cone, slightly curved  
Spülröhrchen, LUER Konus, leicht gebogen  
145 mm, 5 3/4"



**EICKEN**

**OK877R**

Irrigating cannula, LUER cone, shortly curved  
Spülröhrchen, LUER Konus, kurz gebogen  
145 mm, 5 3/4"

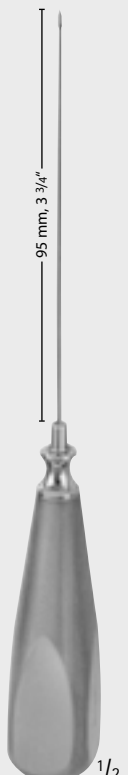

**TILLEY-LICHTWITZ**

**EJ315R-EJ316R**

Antrum trocar  
Antrumtrokar  
200 mm, 7 7/8"

**EJ315R**  
Diam./Ø 1.7 mm

**EJ316R**  
Diam./Ø 2.0 mm



**TILLEY-LICHTWITZ**

**EJ317R-EJ318R**

Antrum trocar  
Antrumtrokar  
185 mm, 7 1/4"

**EJ317R**  
Diam./Ø 2.3 mm

**EJ318R**  
Diam./Ø 2.7 mm



**OK804R-OK805R**

Antrum rasps, American pattern  
Antrumtrephine, amerikanisches Modell  
180 mm, 7"

**OK804R**  
sharp  
scharf

**OK805R**  
blunt  
stumpf

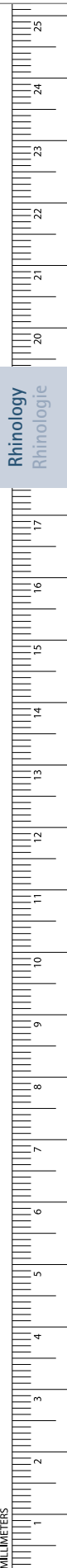

# FESS, Rhinology, Rhinoplasty – FESS, Rhinologie, Septum- und Nasenplastik

## Frontal Sinus Ostium Seeker, Trocars, Irrigating Cannula

### Stirnhöhle-Doppelinstrument, Trokare, Spülkanüle

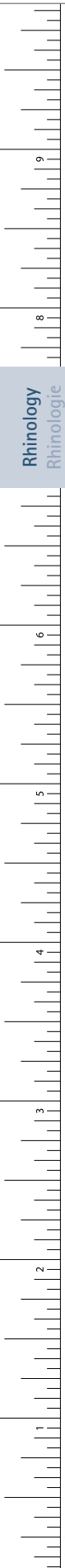

Rhinology  
Rhinologie

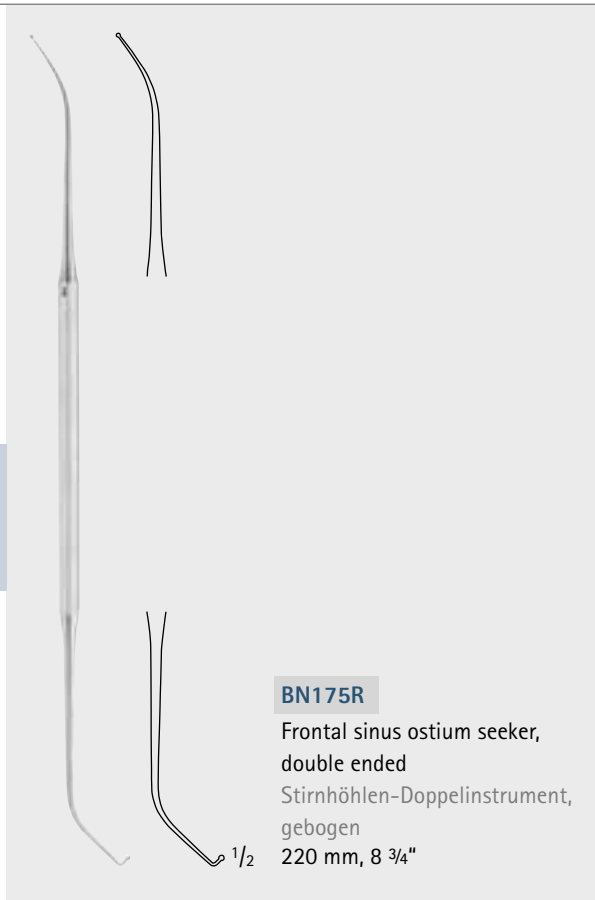

**BN175R**

Frontal sinus ostium seeker,  
double ended  
Stirnhöhlen-Doppelinstrument,  
gebogen  
220 mm, 8 3/4"

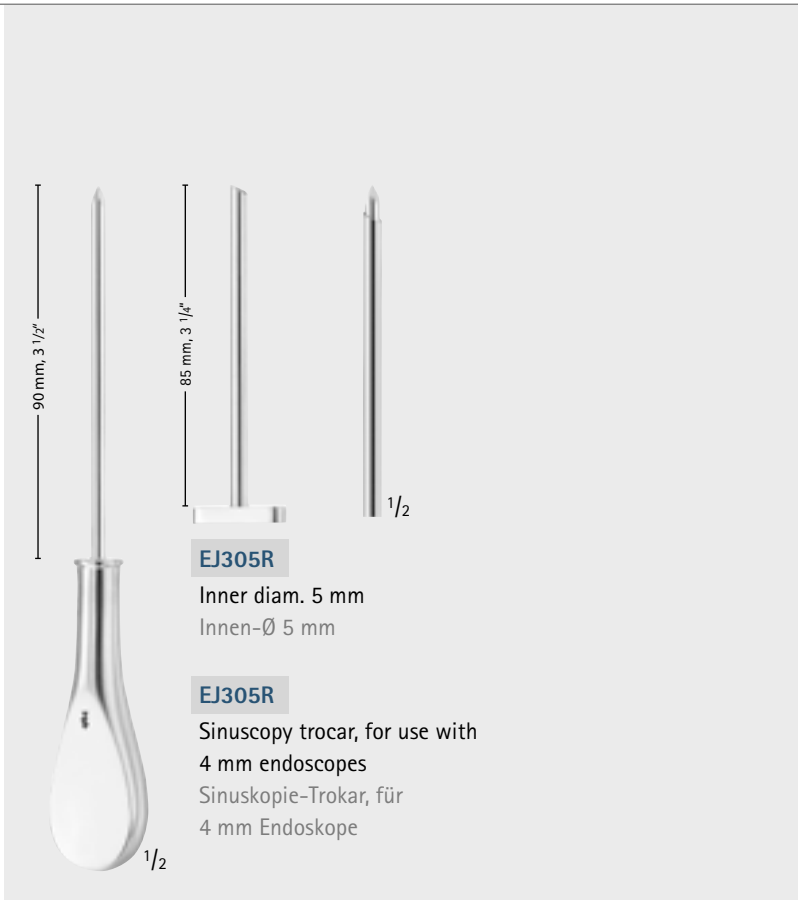

**EJ305R**

Inner diam. 5 mm  
Innen-Ø 5 mm

**EJ305R**

Sinuscopy trocar, for use with  
4 mm endoscopes  
Sinuskopie-Trokar, für  
4 mm Endoskope

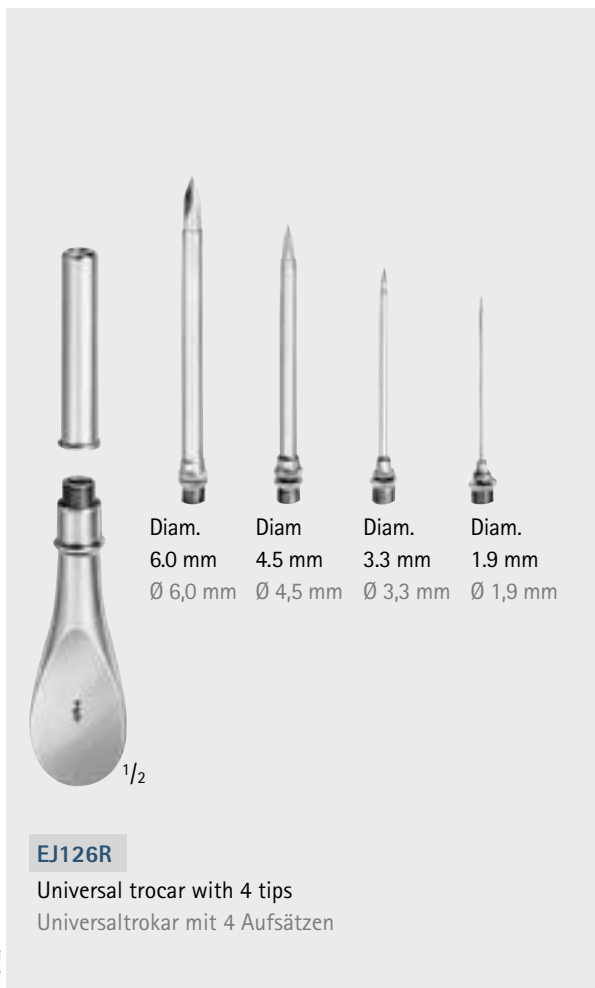

**EJ126R**

Universal trocar with 4 tips  
Universaltrokar mit 4 Aufsätzen

Diam.	Diam	Diam.	Diam.
6.0 mm	4.5 mm	3.3 mm	1.9 mm
Ø 6,0 mm	Ø 4,5 mm	Ø 3,3 mm	Ø 1,9 mm

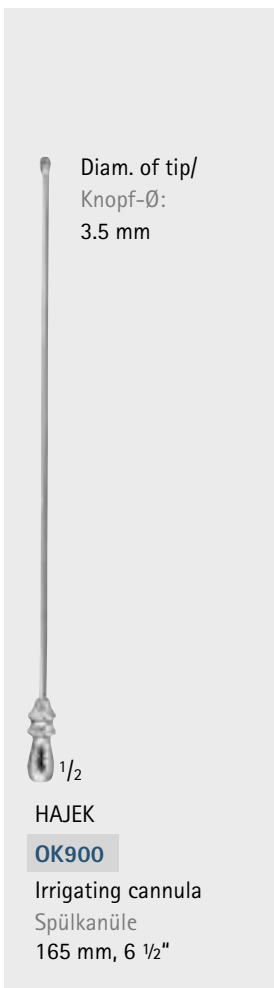

Diam. of tip/  
Knopf-Ø:  
3.5 mm

**HAJEK**

**OK900**

Irrigating cannula  
Spülkanüle  
165 mm, 6 1/2"

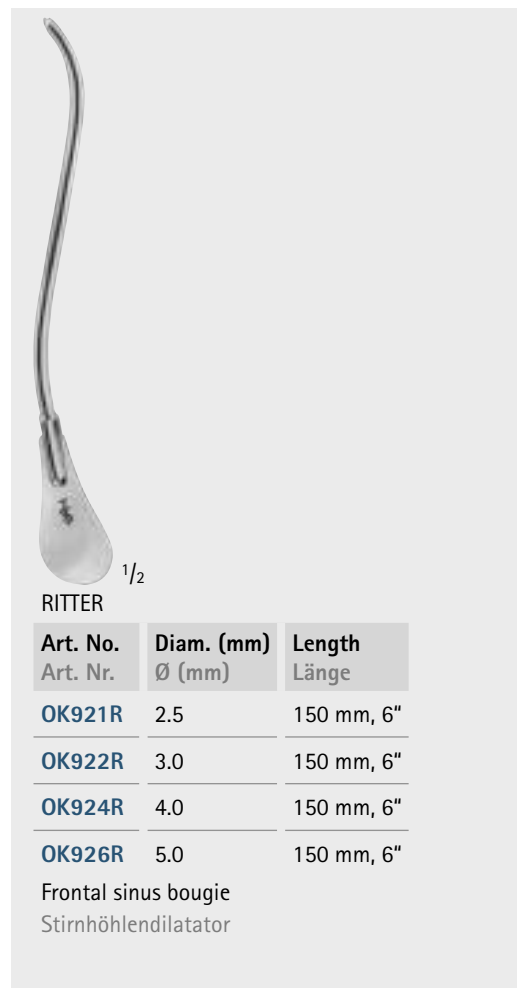

**RITTER**

Art. No. Art. Nr.	Diam. (mm) Ø (mm)	Length Länge
<b>OK921R</b>	2.5	150 mm, 6"
<b>OK922R</b>	3.0	150 mm, 6"
<b>OK924R</b>	4.0	150 mm, 6"
<b>OK926R</b>	5.0	150 mm, 6"

Frontal sinus bougie  
Stirnhöhlel dilatator

## FESS, Rhinology, Rhinoplasty – FESS, Rhinologie, Septum- und Nasenplastik

Hypophysectomy Specula

Hypophysektomie Spekula



## CUSHING-LANDOLT

Art. No.	Blade size (mm)
Art. Nr.	Blattgröße (mm)

OK100R	70 x 15
--------	---------

OK101R	90 x 15
--------	---------

OK102R	110 x 15
--------	----------

Specula for transsphenoidale hypophysectomy

Spekula für transsphenoidale Hypophysektomie



## LANDOLT

OK103R

Spreader, for spreading of specula

OK100R, OK101R, OK102R

Spreizzange, zum Spreizen der Spekula

OK100R, OK101R, OK102R

210 mm, 8 1/4"

# FESS, Rhinology, Rhinoplasty – FESS, Rhinologie, Septum- und Nasenplastik

## Hypophysectomy Specula

## Hypophysektomie Spekula

Rhinology  
Rhinologie

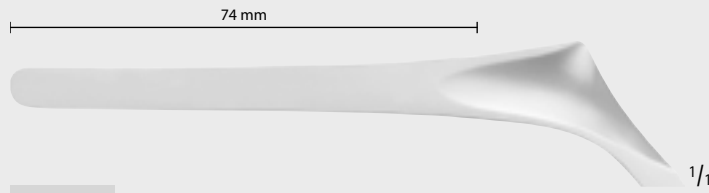

**OK090R**

Fig. 5

Selfretaining septum speculum suitable as introducer for FF590R, FF591R

Septum speculum, aseptic joint. Set-screw, with extra thin blades

Selbsthaltendes Septumspekulum, geeignet als Einführhilfe für FF590R, FF591R

Nasenspekula, mit Steckschluss und Stellschraube, mit besonders schlanken Blättern



COTTLE

**OK090R-OK108R**

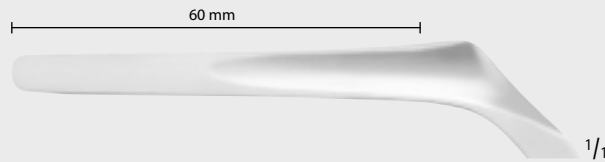

**OK108R**

Fig. 4

Selfretaining septum speculum suitable as introducer for FF589R

Nasal speculum with aseptic joint and set-screw

Selbsthaltendes Septumspekulum, geeignet als Einführungshilfe für FF589R

Nasenspekula mit Steckschluss und Stellschraube



PAPAVERO-CASPAR

Art. No.	Blade size (mm)
Art. Nr.	Blattgröße (mm)

**FF589R** 80 x 11

**FF590R** 90 x 13

**FF591R** 100 x 15

Slim profile and lightweighted specula for Transsphenoidal surgery with key TE749R

Schlanke und leichte Spekula für die Transsphenoidaloperation inkl. Spannschlüssel TE749R



**FF590B**

Noir® Transsphenoidal speculum with key TE749R

Noir® Hypophysenspekulum inkl. Spannschlüssel TE749R

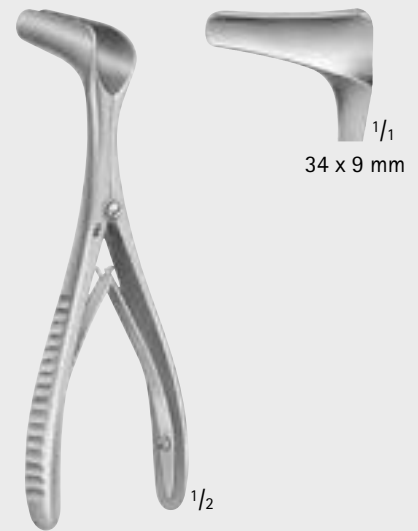

PAPAVERO-HARTMANN

**FF595R**

Spreader for specula FF589R, FF590R, FF591R

Spreizer für Spekula FF589R, FF590R, FF591R

140 mm, 5 1/2"



## FESS, Rhinology, Rhinoplasty – FESS, Rhinologie, Septum- und Nasenplastik

Micro Scissors and -Forceps

Mikro-Scheren und -Zangen

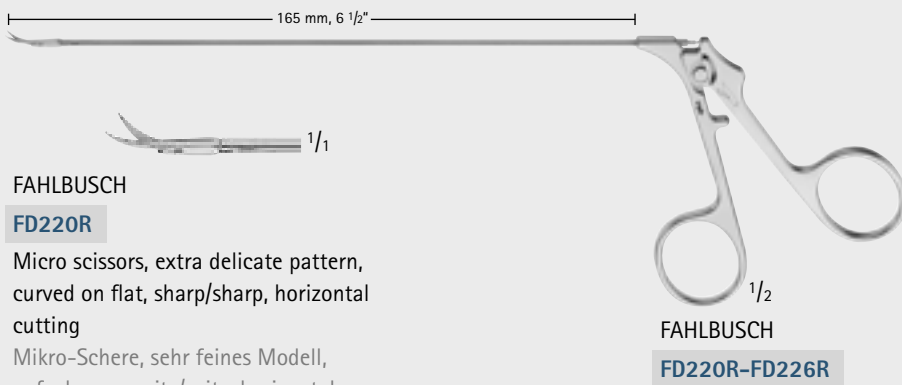

FD222R

Forceps, scoop-shaped, diam. 2.5 mm  
Scharfe Zange mit löffelförmigen Maul,  
Ø 2,5 mm



FD224R

Grasping forceps with long conical jaw  
Fasszange mit feinem Maul



FD226R

Micro scissors, straight  
Mikro-Schere, gerade

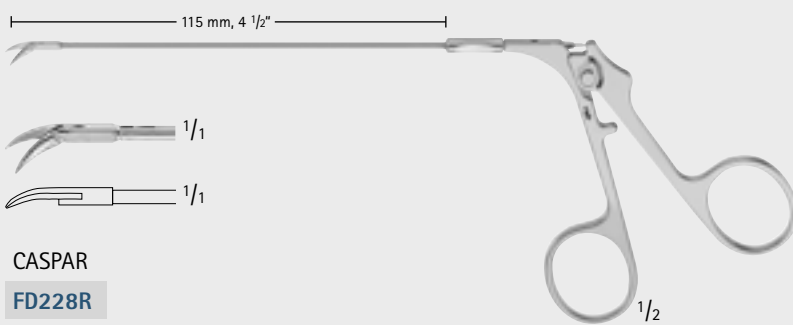

# FESS, Rhinology, Rhinoplasty – FESS, Rhinologie, Septum- und Nasenplastik

## Micro-Scissors, Micro Forceps

### Mikro-Scherchen, Mikro-Fasszängchen

180 mm, 7"

**FA072R**  
straight  
gerade

**FA073R**  
left curved  
links gebogen

**FA074R**  
right curved  
rechts gebogen

**FA075R**  
angular  
gewinkelt

**FA072R-FA075R**  
Micro scissors  
Mikro-Scherchen

Rhinology  
Rhinologie

INCHES

180 mm, 7"

**FA069R**  
straight  
gerade

**FA070R**  
right curved  
rechts gebogen

**FA071R**  
left curved  
links gebogen

**FA069R-FA071R**  
Micro forceps  
Mikro-Fasszängchen

INCHES

# FESS, Rhinology, Rhinoplasty – FESS, Rhinologie, Septum- und Nasenplastik

## Rongeurs, Tumor Grasping Forceps

### Rongeurs, Tumorfasszange

180 mm, 7"

1/1 Diam. / Ø 7.0 mm

**OLDBERG**  
**FF605R**  
 Rongeur  
 Rongeur

1/2

190 mm, 7 1/2"

1/1 Diam. / Ø 2.2 mm

**FF599R**

1/1 Diam. / Ø 3.5 mm

**FF600R**

**YASARGIL**  
**FF599R-FF600R**  
 Rongeur  
 Rongeur

1/2

210 mm, 8 1/4"

1/1

1/1 Diam. / Ø 9.0 mm

**LANDOLT**  
**FF345R**  
 Tumor grasping forceps, blunt  
 Tumorfasszange, stumpf

1/2

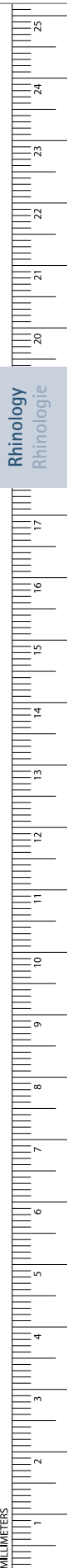

Rhinology  
 Rhinologie

MILLIMETERS

- Please find bone punches in chapter bone instruments, starting on page 255
- Knochenstanzen siehe Kapitel Knocheninstrumente, ab Seite 255

# FESS, Rhinology, Rhinoplasty – FESS, Rhinologie, Septum- und Nasenplastik

Curette, Knife, Dissector, deflectable, Currettes, Enucleators

Kürette, Messer, Dissektor, abwinkelbar, Küretten, Eukleatoren



**FD137R**

Deflectable curette  
Abwinkelbare Kürette



**FD138R**

Deflectable knife  
Abwinkelbares Messer



Width: 2.1 mm  
Breite: 2,1 mm

**FD139R**

Deflectable dissector  
Abwinkelbarer Dissektor

**FD137R-FD139R**

Working length: 135 mm, 5 1/4"  
Total length: 265 mm, 10 1/2"  
Arbeitslänge: 135 mm, 5 1/4"  
Gesamtlänge: 265 mm, 10 1/2"



**NICOLA**

**FA041R**

Curette,  
diam. 6.5 mm,  
45° vertical  
angled,  
long neck  
Kürette,  
Ø 6,5 mm,  
45° vertikal  
ewinkelt,  
langer Hals



**NICOLA**

**FA042R**

Curette,  
diam. 6.5 mm,  
45° horizontal  
angled,  
short neck  
Kürette,  
Ø 6,5 mm,  
45° horizontal  
ewinkelt,  
kurzer Hals



**HARDY**

**FA043R**

Enucleator,  
left cutting  
Eukleator,  
links schneidend



**HARDY**

**FA044R**

Enucleator,  
right cutting  
Eukleator,  
rechts schneidend



**HARDY**

**FA045R**

Curette,  
diam. 4.0 mm,  
90° left angled,  
long neck  
Kürette,  
Ø 4,0 mm,  
90° nach links  
ewinkelt,  
langer Hals



**HARDY**

**FA046R**

Curette,  
diam. 4.0 mm,  
90° left angled,  
short neck  
Kürette,  
Ø 4,0 mm,  
90° nach links  
gewinkelt,  
kurzer Hals

**FA041R-FA068R**

Working length: 130 mm, 5 1/8"  
Total length: 280 mm, 11"  
Arbeitslänge: 130 mm, 5 1/8"  
Gesamtlänge: 280 mm, 11"

Rhinology  
Rhinologie

INCHES

## FESS, Rhinology, Rhinoplasty – FESS, Rhinologie, Septum- und Nasenplastik

Curettes, Micro Hook, Dissector  
Küretten, Mikro-Häkchen, Dissektor

HARDY

**FA047R**

Curette,  
diam. 4.0 mm,  
90° right angled,  
long neck  
Kürette,  
Ø 4,0 mm,  
90° nach rechts  
gewinkelt,  
langer Hals



HARDY

**FA060R**

Curette,  
diam.  
4.0 mm,  
90° right angled,  
short neck  
Kürette,  
Ø 4,0 mm,  
90° nach rechts  
gewinkelt,  
kurzer Hals



HARDY

**FA061R**

Curette,  
diam. 4.0 mm,  
45° horizontal  
left angled,  
short neck  
Kürette,  
Ø 4,0 mm,  
45° horizontal  
nach links  
gewinkelt,  
kurzer Hals



HARDY

**FA062R**

Curette,  
diam. 4.0 mm,  
45° horizontal  
right angled,  
short neck  
Kürette,  
Ø 4,0 mm,  
45° horizontal  
nach rechts  
gewinkelt,  
kurzer Hals



HARDY

**FA063R**

Curette,  
diam. 6.0 mm,  
90° left angled,  
long neck  
Kürette,  
Ø 6,0 mm,  
90° nach links  
gewinkelt,  
langer Hals



HARDY

**FA064R**

Curette,  
diam. 6.0 mm,  
90° left angled,  
short neck  
Kürette,  
Ø 6,0 mm,  
90° nach links  
gewinkelt,  
kurzer Hals



HARDY

**FA065R**

Curette,  
diam. 6.0 mm,  
90° right angled,  
long neck  
Kürette,  
Ø 6,0 mm,  
90° nach rechts  
gewinkelt,  
langer Hals



HARDY

**FA066R**

Curette,  
diam. 6.0 mm,  
90° right angled,  
short neck  
Kürette,  
Ø 6,0 mm,  
90° nach rechts  
gewinkelt,  
kurzer Hals



LANDOLT-REULEN

**FA067R**

Micro hook,  
diam. 1.7 mm  
Mikro-Häkchen,  
Ø 1,7 mm



LANDOLT-REULEN

**FA068R**

Dissector,  
diam. 2.0 mm,  
blunt  
Dissektor,  
Ø 2,0 mm,  
stumpf

Rhinology  
Rhinologie

MILLIMETERS

# FESS, Rhinology, Rhinoplasty – FESS, Rhinologie, Septum- und Nasenplastik

Curettes, Enucleators, Micro Hook, Dissector

Küretten, Enukleatoren, Mikro-Häkchen, Dissektor

Rhinology  
Rhinologie

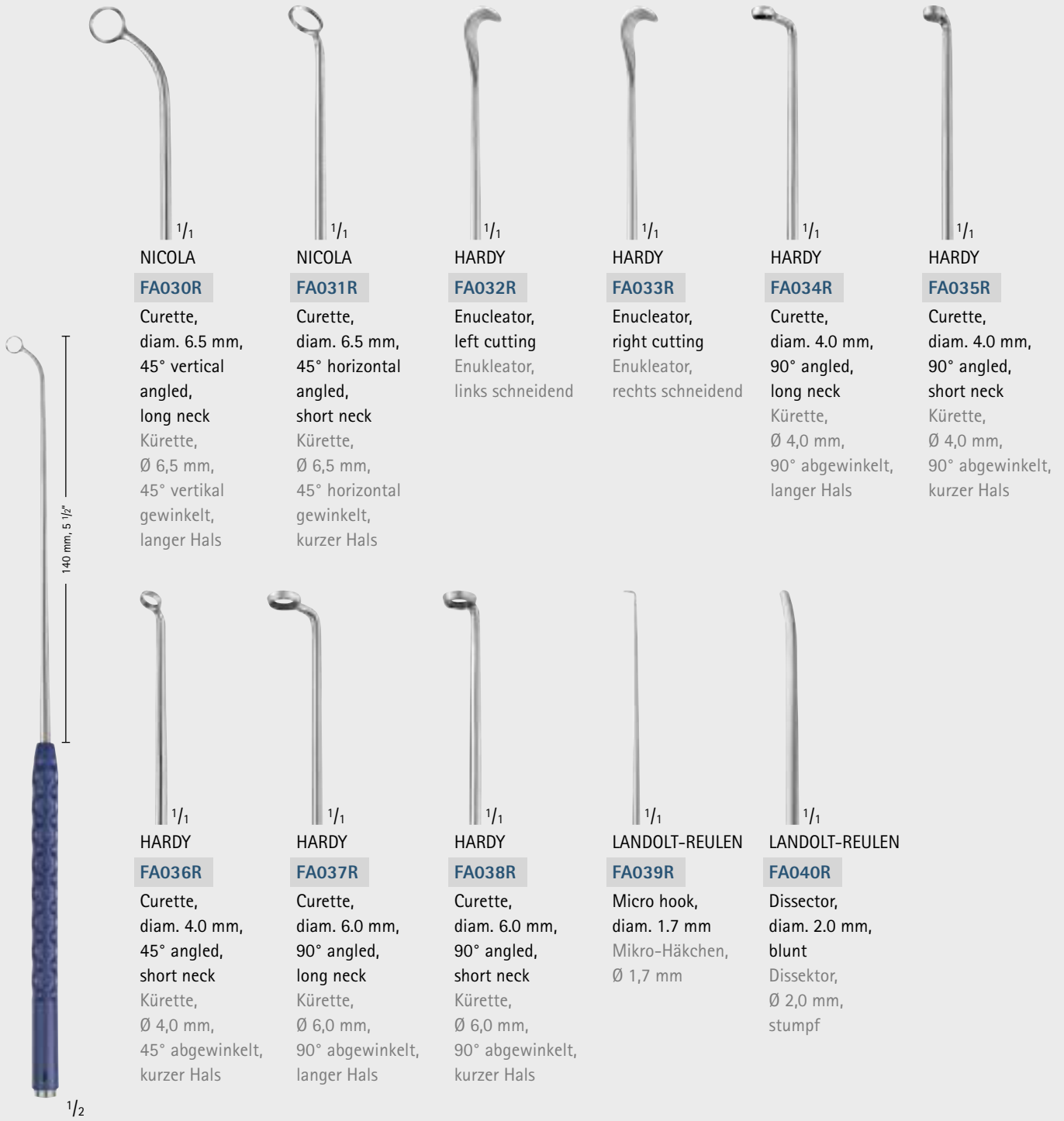

NICOLA  
**FA030R**

Curette,  
diam. 6.5 mm,  
45° vertical  
angled,  
long neck  
Kürette,  
Ø 6,5 mm,  
45° vertikal  
gewinkelt,  
langer Hals

NICOLA  
**FA031R**

Curette,  
diam. 6.5 mm,  
45° horizontal  
angled,  
short neck  
Kürette,  
Ø 6,5 mm,  
45° horizontal  
gewinkelt,  
kurzer Hals

HARDY  
**FA032R**

Enucleator,  
left cutting  
Enukleator,  
links schneidend

HARDY  
**FA033R**

Enucleator,  
right cutting  
Enukleator,  
rechts schneidend

HARDY  
**FA034R**

Curette,  
diam. 4.0 mm,  
90° angled,  
long neck  
Kürette,  
Ø 4,0 mm,  
90° abgewinkelt,  
langer Hals

HARDY  
**FA035R**

Curette,  
diam. 4.0 mm,  
90° angled,  
short neck  
Kürette,  
Ø 4,0 mm,  
90° abgewinkelt,  
kurzer Hals

HARDY  
**FA036R**

Curette,  
diam. 4.0 mm,  
45° angled,  
short neck  
Kürette,  
Ø 4,0 mm,  
45° abgewinkelt,  
kurzer Hals

HARDY  
**FA037R**

Curette,  
diam. 6.0 mm,  
90° angled,  
long neck  
Kürette,  
Ø 6,0 mm,  
90° abgewinkelt,  
langer Hals

HARDY  
**FA038R**

Curette,  
diam. 6.0 mm,  
90° angled,  
short neck  
Kürette,  
Ø 6,0 mm,  
90° abgewinkelt,  
kurzer Hals

LANDOLT-REULEN  
**FA039R**

Micro hook,  
diam. 1.7 mm  
Mikro-Häkchen,  
Ø 1,7 mm

LANDOLT-REULEN  
**FA040R**

Dissector,  
diam. 2.0 mm,  
blunt  
Dissektor,  
Ø 2,0 mm,  
stumpf

**FA030R-FA040R**

Working length: 140 mm, 5 1/2"  
Total length: 265 mm, 10 1/2"  
Straight design: with ergonomic  
grasping part and semi-sharp tips  
Arbeitslänge: 140 mm, 5 1/2"  
Gesamtlänge: 265 mm, 10 1/2"  
Schaftdesign: gerade, mit  
ergonomischem Handgriff und  
halbscharfen Arbeitsenden

# MINOP® TREND

TRansnasal ENDoscopic System



For further informations about Operating Manual and product overview see brochure no. C26402.

Weitere Informationen über OP-Anleitung und Produktübersicht MINOP® finden Sie im Prospekt Nr. C26402.

For further informations about Endoscopy Units and Accessories see brochure no. C46702.

Weitere Informationen über Geräte und Optiken finden Sie im Prospekt Nr. C46701.

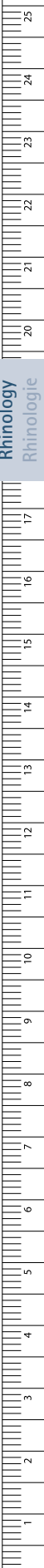

# FESS, Rhinology, Rhinoplasty - FESS, Rhinologie, Septum- und Nasenplastik

## Nasal Scissors

### Nasenscheren



Rhinology  
Rhinologie

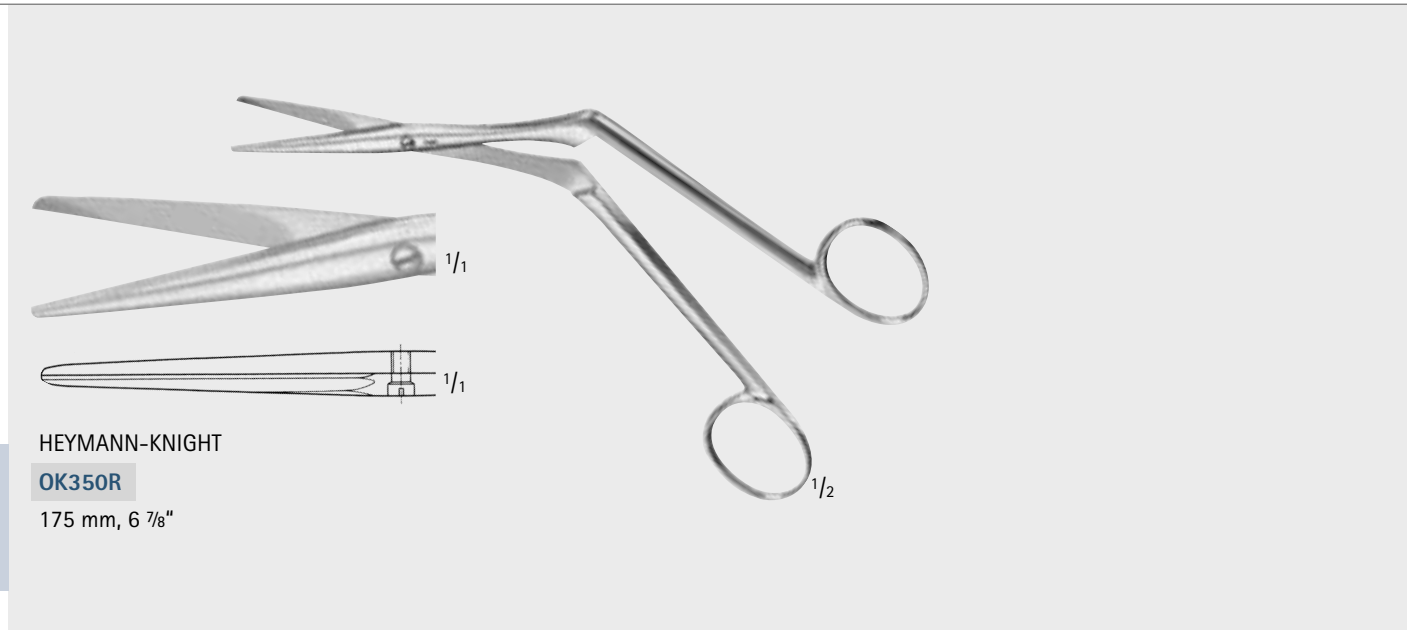

HEYMANN-KNIGHT

**OK350R**

175 mm, 6 7/8"

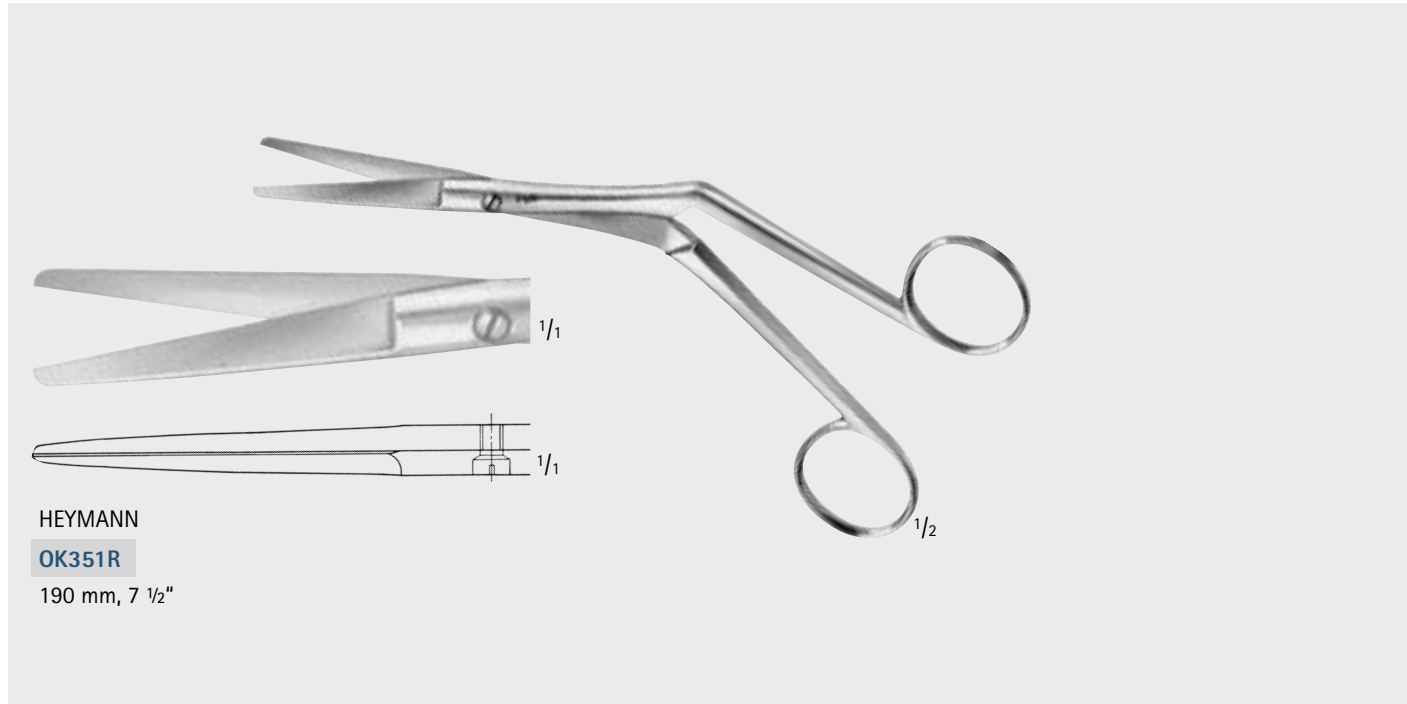

HEYMANN

**OK351R**

190 mm, 7 1/2"

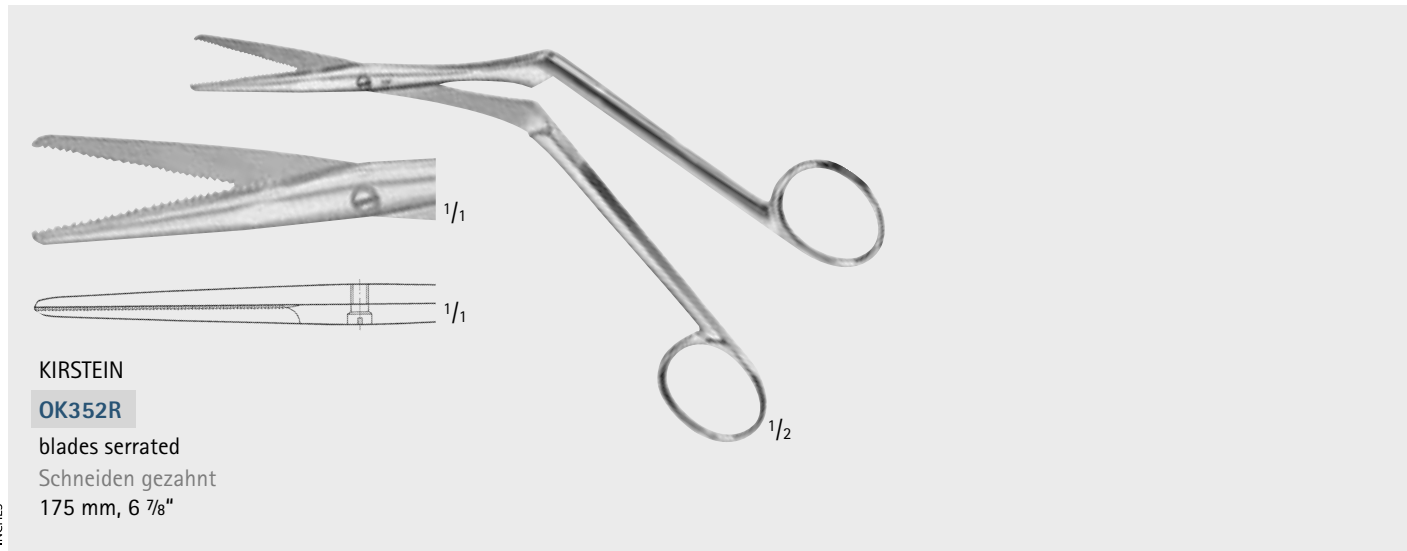

KIRSTEIN

**OK352R**

blades serrated

Schneiden gezahnt

175 mm, 6 7/8"



# FESS, Rhinology, Rhinoplasty – FESS, Rhinologie, Septum- und Nasenplastik

## Nasal Scissors, Septum Scissors

### Nasenscheren, Septumschere

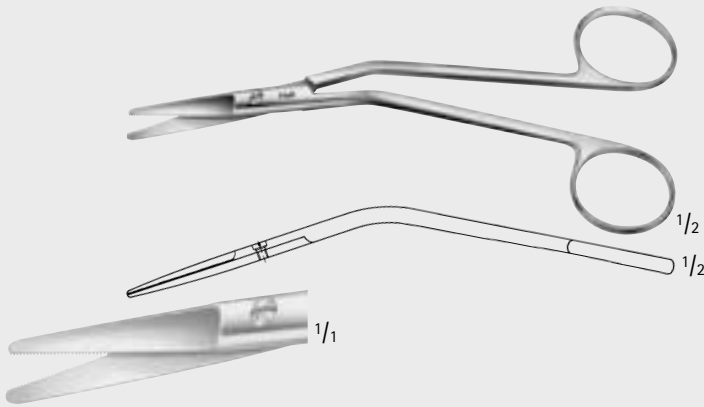

FOMON

**OK370R**

Nasal scissors, straight, serrated blades, angled handle, blunt/blunt  
 Nasenschere, beide Schneiden gezahnt, kniegebogen, stumpf/stumpf  
 145 mm, 5 3/4"

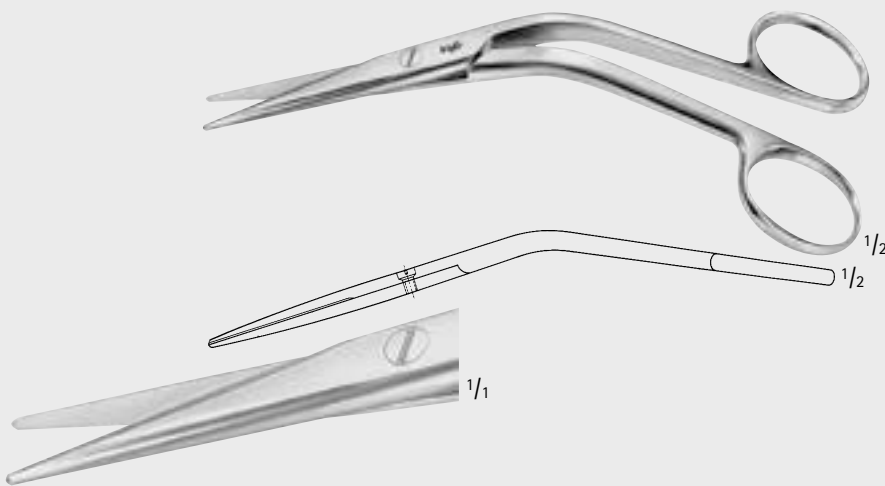

COTTLE

**OK371R**

Nasal scissors, straight blades, angled handle, blunt/blunt  
 Nasenschere, kniegebogen, stumpf/stumpf  
 165 mm, 6 1/2"

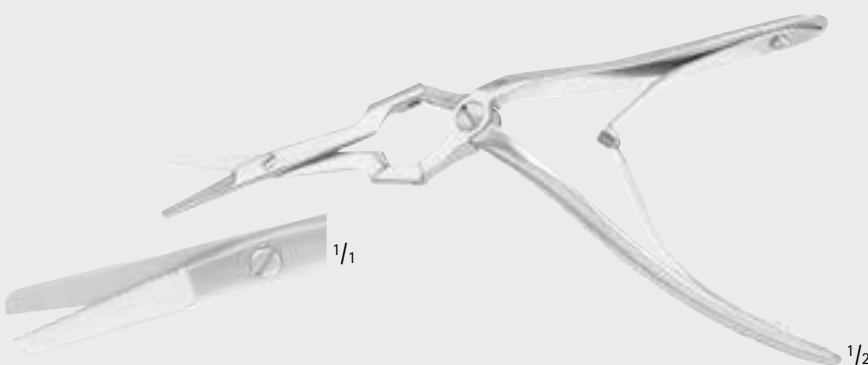

**OK353R**

Septum scissors with double joint, blades serrated  
 Septumschere mit Doppelgelenk, Schneiden gezahnt  
 180 mm, 7"



Rhinologie  
 Rhinologie

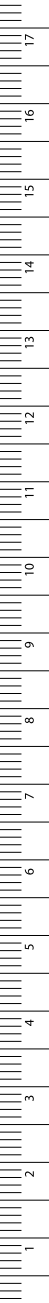

MILLIMETERS

# FESS, Rhinology, Rhinoplasty – FESS, Rhinologie, Septum- und Nasenplastik

## Nasal Dressing Forceps

### Nasentamponzangen

Rhinology  
Rhinologie

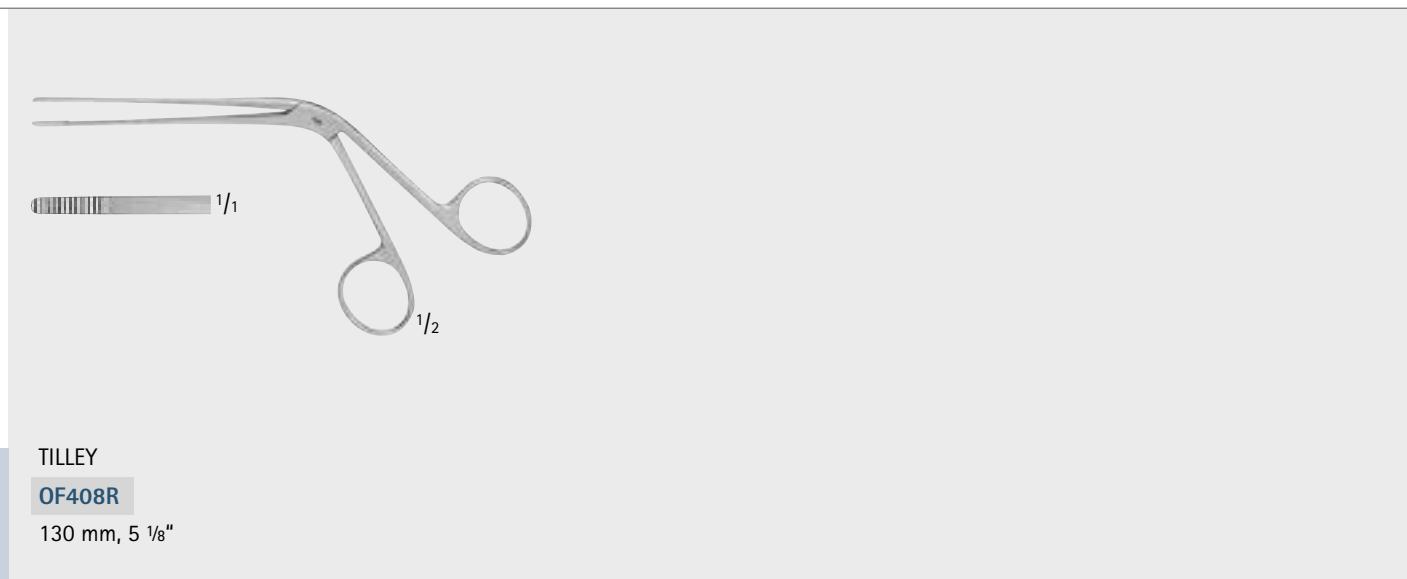
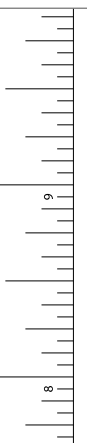

TILLEY  
**OF408R**  
130 mm, 5 1/8"

Rhinology  
Rhinologie



LUBET-BARBON  
**OK225R**  
200 mm, 7 7/8"

Rhinology  
Rhinologie

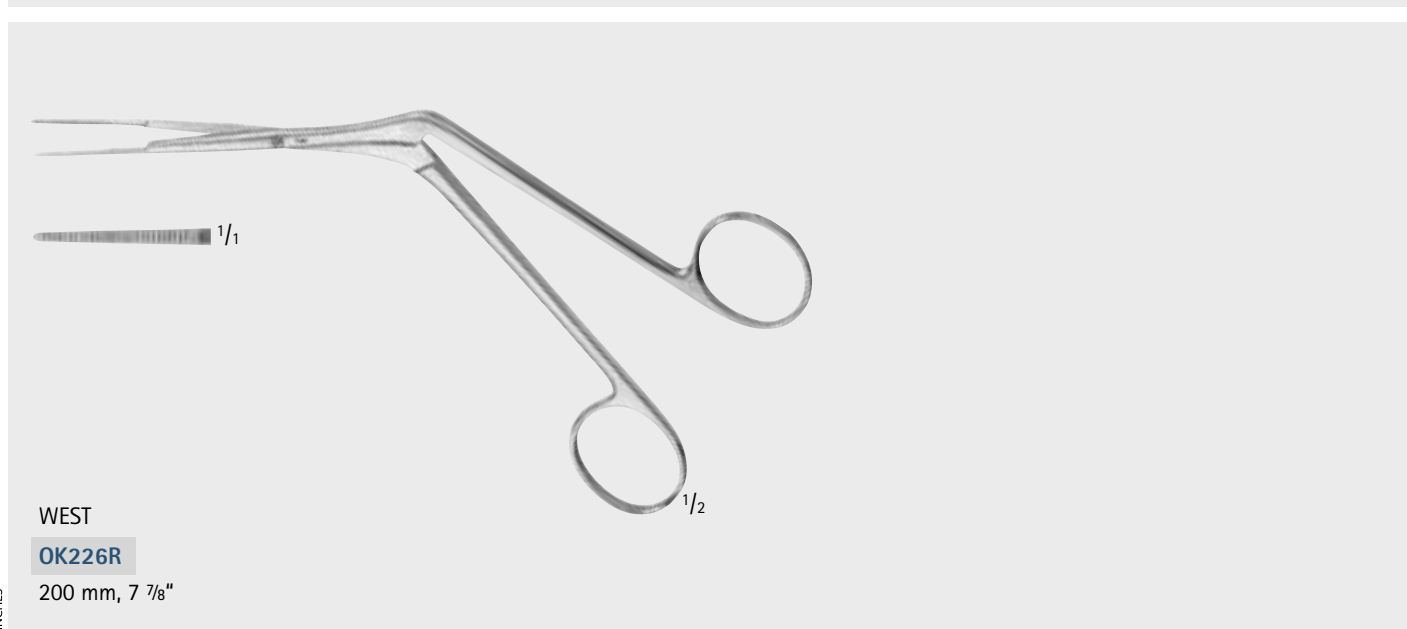

WEST  
**OK226R**  
200 mm, 7 7/8"

# FESS, Rhinology, Rhinoplasty – FESS, Rhinologie, Septum- und Nasenplastik

## Nasal Dressing Forceps

### Nasentamponzangen

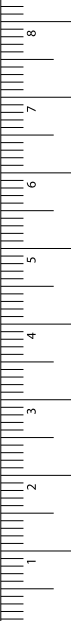
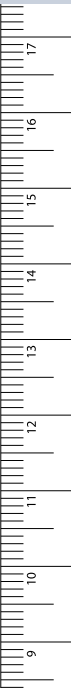
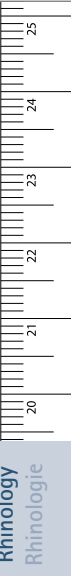
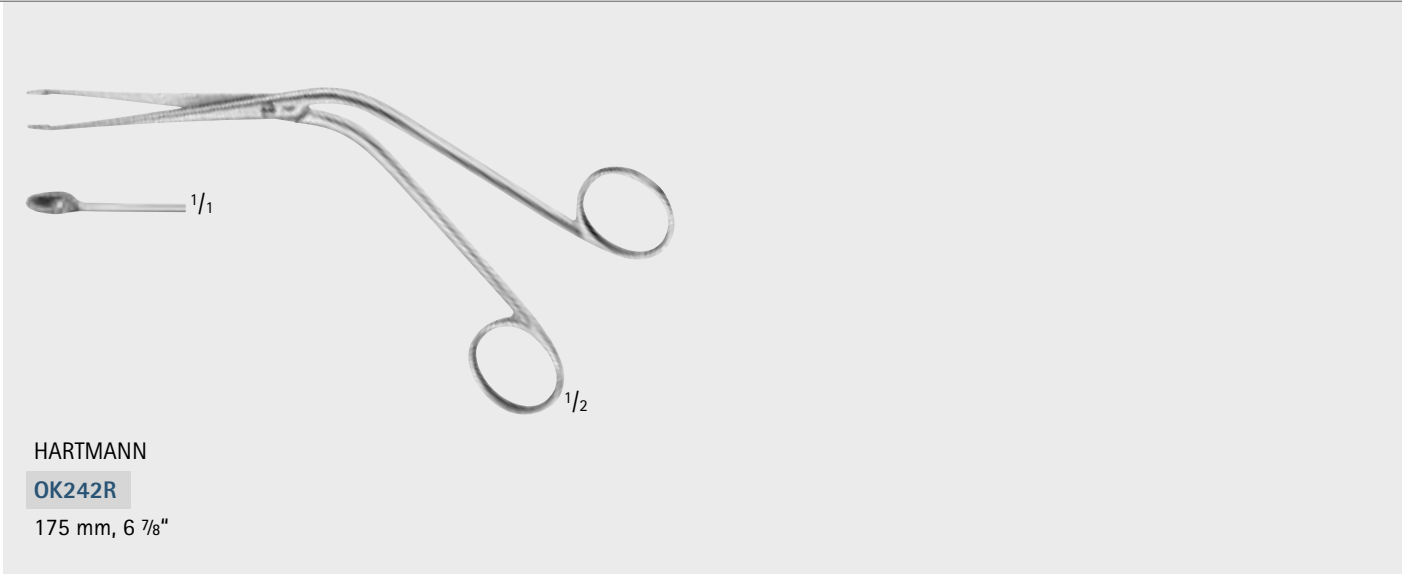

# FESS, Rhinology, Rhinoplasty – FESS, Rhinologie, Septum- und Nasenplastik

## Nasal Forceps

### Nasenzangen

Rhinology  
Rhinologie



JANSEN-MIDDLETON

**OK400R**

spoon-shaped, biting  
aufeinanderschneidend  
200 mm, 7 7/8"

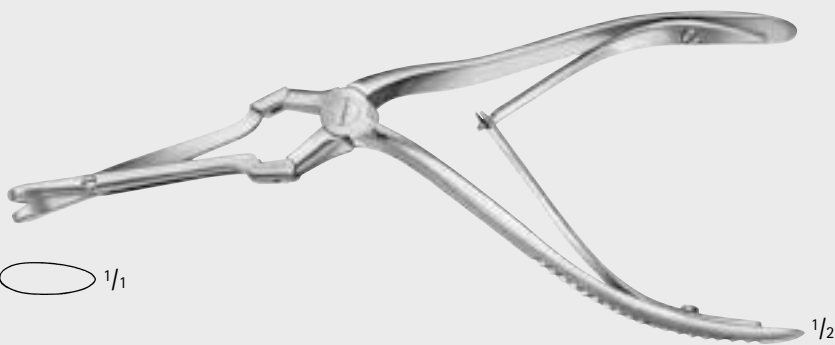

JANSEN-MIDDLETON

**OK405R**

through cutting  
durchschneidend  
210 mm, 8 1/4"

## FESS, Rhinology, Rhinoplasty – FESS, Rhinologie, Septum- und Nasenplastik

Septum Forceps

Septumzangen

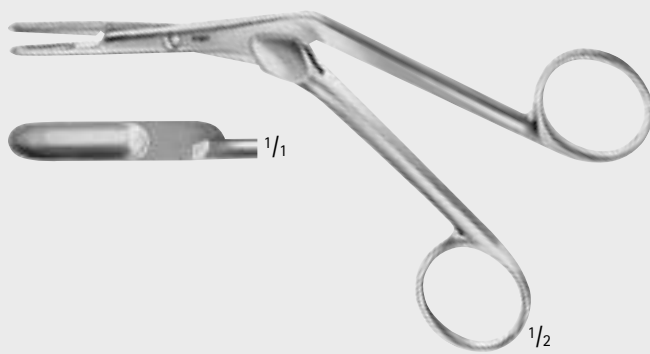

CRAIG

**OK410R**

Septum bone cutting and breaking forceps, straight, sharp spoons

Vomerzange, gerade, scharfe Löffel

165 mm, 6 1/2"

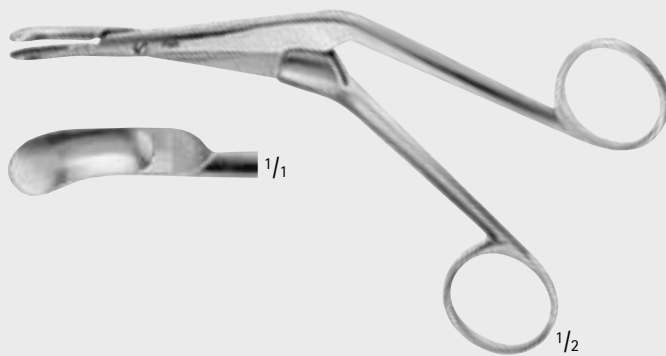

CRAIG-DOMNICK

**OK412R**

Septum bone cutting and breaking forceps, curved to the left, sharp spoons

Vomerzange, linksgebogen, scharfe Löffel

165 mm, 6 1/2"

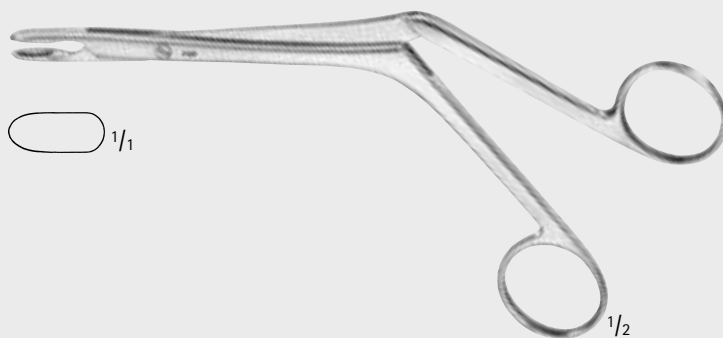

HEYMANN-KNIGHT

**OK422R**

Septum forceps, with sharp oval spoons

Septumzange, mit scharfen, ovalen Löffeln

190 mm, 7 1/2"

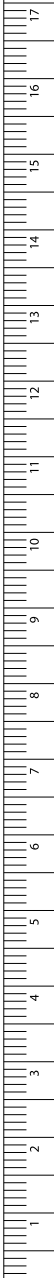
Rhinology  
Rhinologie

MILLIMETERS

# FESS, Rhinology, Rhinoplasty – FESS, Rhinologie, Septum- und Nasenplastik

Nasal Mirror, Mucous Knife, Swivel Knife

Nasenspiegel, Mukosamesser, Schwingmesser

Rhinology  
Rhinologie

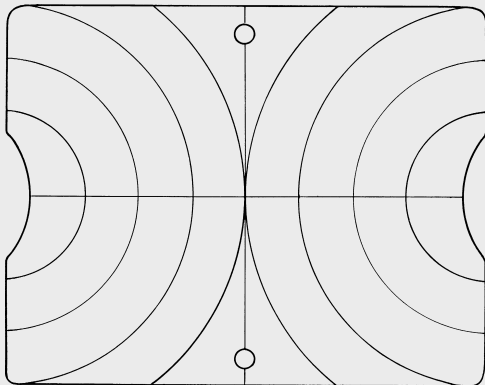

GLATZEL

**OK001**

Nasal mirror

Nasenspiegel

200 x 130 mm, 7 7/8 x 5 1/8"



CASTROVIEJO

**OB792R**

Caliper,

measuring range 0-15 mm

Messzirkel,

Messbereich 0-15 mm

75 mm, 3"



FREER

**OL120R**

Mucous knife

Mukosamesser

150 mm, 6"



BALLENGER

**OL354R-OL356R**

Swivel knife, bayonet shaped

Schwingmesser, bajonettförmig

210 mm, 8 1/4"

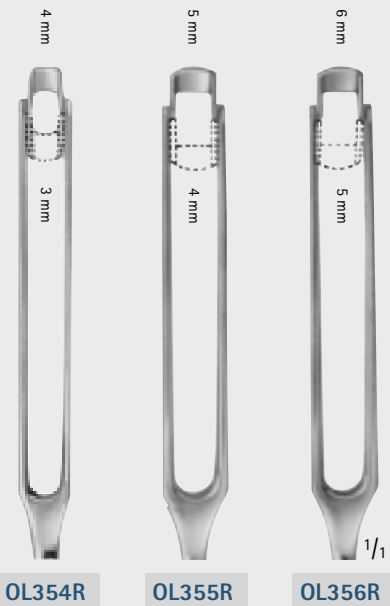

**OL354R**

**OL355R**

**OL356R**

# FESS, Rhinology, Rhinoplasty – FESS, Rhinologie, Septum- und Nasenplastik

## Cartilage Slitting Knife, Nasal Knives

### Knorpelritz-, Nasenmesser



MASING

**OL114R**

Cartilage slitting knife,  
curved blade, pointed  
Knorpelritzmesser,  
in der Spitze gebogen  
130 mm, 5 1/8"



JOSEPH

**OL102R-OL104R**

double-edged nasal knives,  
pointed  
Plastikmesser  
145 mm, 5 3/4"



JOSEPH

**OL107R**

Button-end knife, angled,  
for removal of cartilage  
Zugmesser zum Abtragen von  
Knorpelvorsprüngen des Septums  
175 mm, 6 7/8"

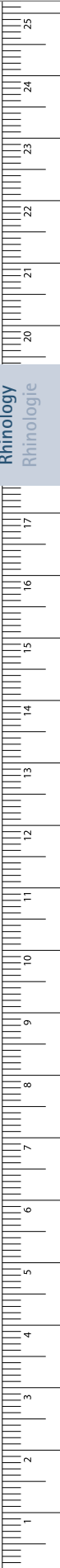

# FESS, Rhinology, Rhinoplasty – FESS, Rhinologie, Septum- und Nasenplastik

## Nasal Knives, Milium Knife, Lupus Spatula

### Nasen-, Milienmesser, Lupuspatel



Rhinology  
Rhinologie



CONVERSE

**OL109R**

Button-end knife,  
curved

Plastikmesser, gebogen,  
Spitze verrundet  
150 mm, 6"



JOSEPH

**OL111R**

Button-end knife,  
straight

Plastikmesser, gerade,  
Spitze verrundet  
140 mm, 5 1/2"



COTTLE

**OL112R**

Septum knife  
Septummesser

150 mm, 6"



COTTLE

**OL113R**

Septum knife, stiff blade  
with rounded edge

Septummesser,  
abgerundete Kanten  
140 mm, 5 1/2"



VIDAL

**OL699R**

Lupus spatula  
Lupuspatel

135 mm, 5 1/4"



# FESS, Rhinology, Rhinoplasty – FESS, Rhinologie, Septum- und Nasenplastik

## Nasal Saws, Raspatory, Elevators



### Nasensägen, Raspatorium, Elevatorien



4.1 mm  
35 mm

**JOSEPH**  
**OL448R**  
Nasal saw, straight  
Nasensäge, gerade  
195 mm, 7 3/4"

1/2

1/1

**JOSEPH**  
**OL451R**  
Nasal saw, bayonet shaped,  
curved to the right  
Nasensäge, bajonettförmig,  
rechts gebogen  
195 mm, 7 3/4"

1/2



**JOSEPH**  
**OL452R**  
Nasal saw, bayonet shaped,  
curved to the left  
Nasensäge, bajonettförmig,  
links gebogen  
195 mm, 7 3/4"



1/2



1/1

**PENNINGTON**  
**OL151R**  
Raspatory  
Raspatorium  
210 mm, 8 1/4"



1/2 1/1

1/1

**COTTLE**  
**OL152R**  
Elevator, graduated  
Elevatorium mit  
Graduierung  
200 mm, 7 7/8"

1/2 1/1

1/1

**MASING**  
**OL153R**  
Elevator, graduated  
Elevatorium mit  
Graduierung  
200 mm, 7 7/8"

1/2 1/1

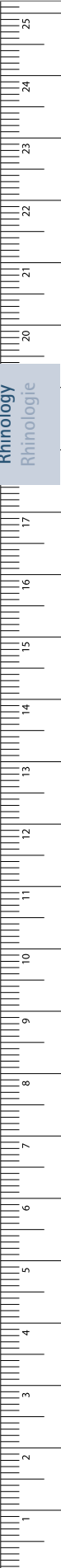

# FESS, Rhinology, Rhinoplasty – FESS, Rhinologie, Septum- und Nasenplastik

## Raspatories, Dissectors, Elevators

### Raspatorien, Elevatoren, Dissektoren



Rhinology  
Rhinologie

**KILLIAN**  
**OL170R**  
blunt/sharp  
stumpf/scharf  
185 mm, 7 1/4"

**MAC DONALD**  
**FK291R**  
blunt/blunt  
stumpf/stumpf  
185 mm, 7 1/4"

**WATSON-CHEYNE**  
**FK292R-FK293R**  
**FK292R**  
blunt/blunt  
stumpf/stumpf  
130 mm, 5 1/8"  
**FK293R**  
blunt/blunt  
stumpf/stumpf  
190 mm, 7 1/2"

**FREER**  
**OL164R**  
sharp/blunt  
scharf/stumpf  
180 mm, 7"

**FREER**  
**OL165R**  
blunt/sharp  
stumpf/scharf  
185 mm, 7 1/4"

**FREER**  
**OL154R**  
blunt/sharp  
stumpf/scharf  
185 mm, 7 1/4"

**FREER-YASARGIL**  
**OL166R**  
sharp/sharp  
scharf/scharf  
185 mm, 7 1/4"

FESS, Rhinology, Rhinoplasty – FESS, Rhinologie, Septum- und Nasenplastik

Raspatory, Elevators

Raspatorium, Elevatoren

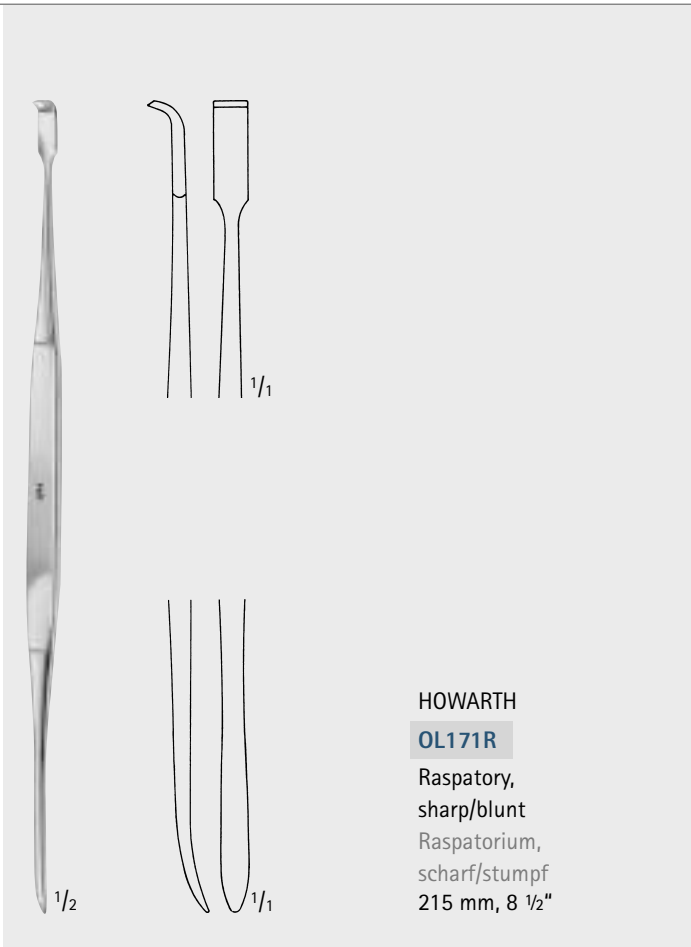

**HOWARTH**  
**OL171R**  
 Raspatory,  
 sharp/blunt  
 Raspatorium,  
 scharf/stumpf  
 215 mm, 8 1/2"

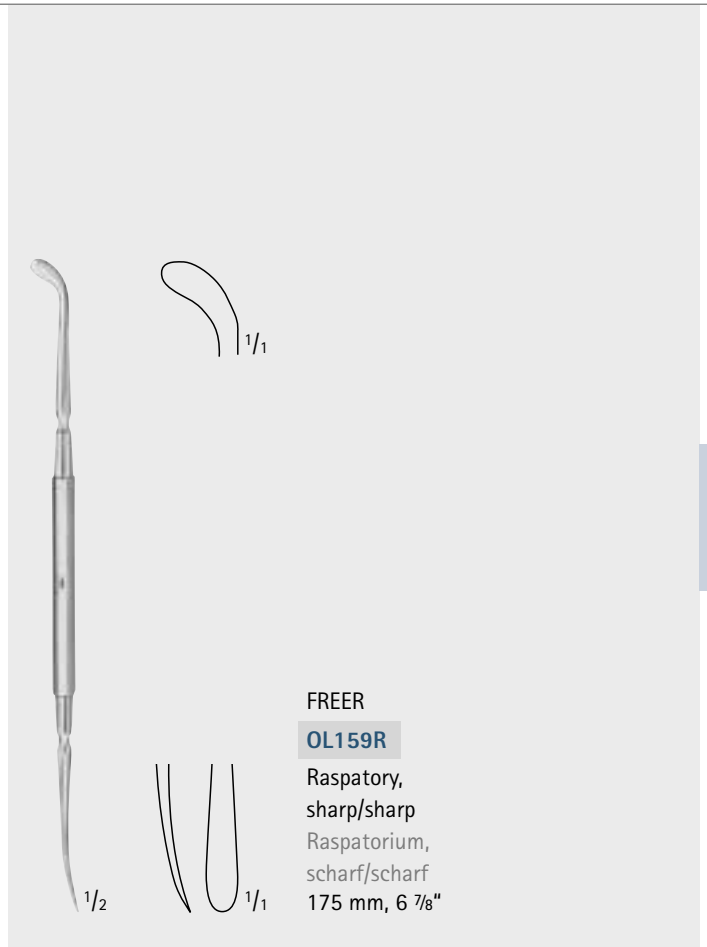

**FREER**  
**OL159R**  
 Raspatory,  
 sharp/sharp  
 Raspatorium,  
 scharf/scharf  
 175 mm, 6 7/8"

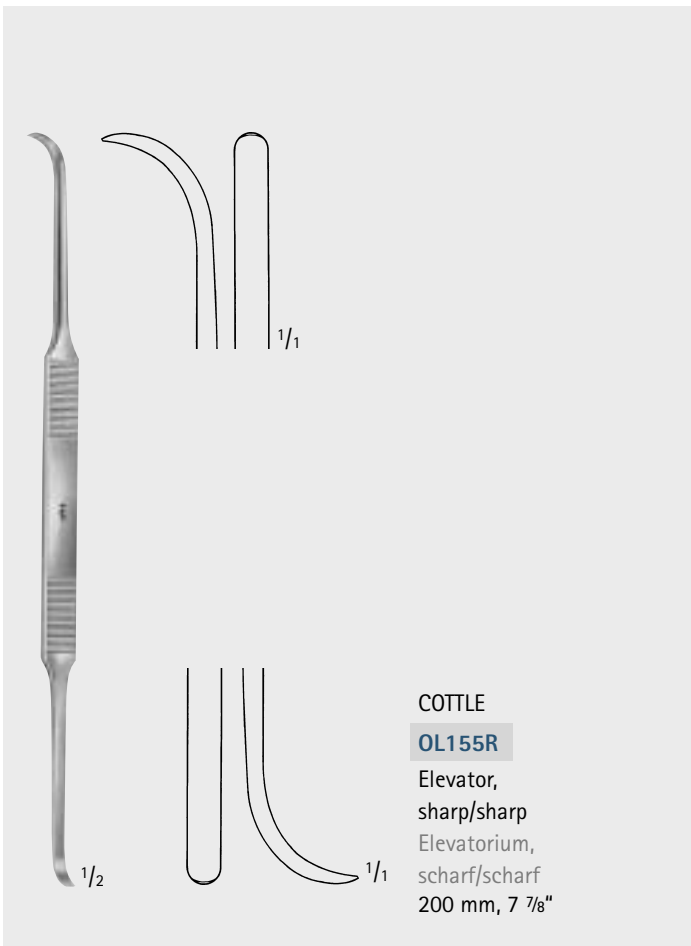

**COTTLE**  
**OL155R**  
 Elevator,  
 sharp/sharp  
 Elevatorium,  
 scharf/scharf  
 200 mm, 7 7/8"

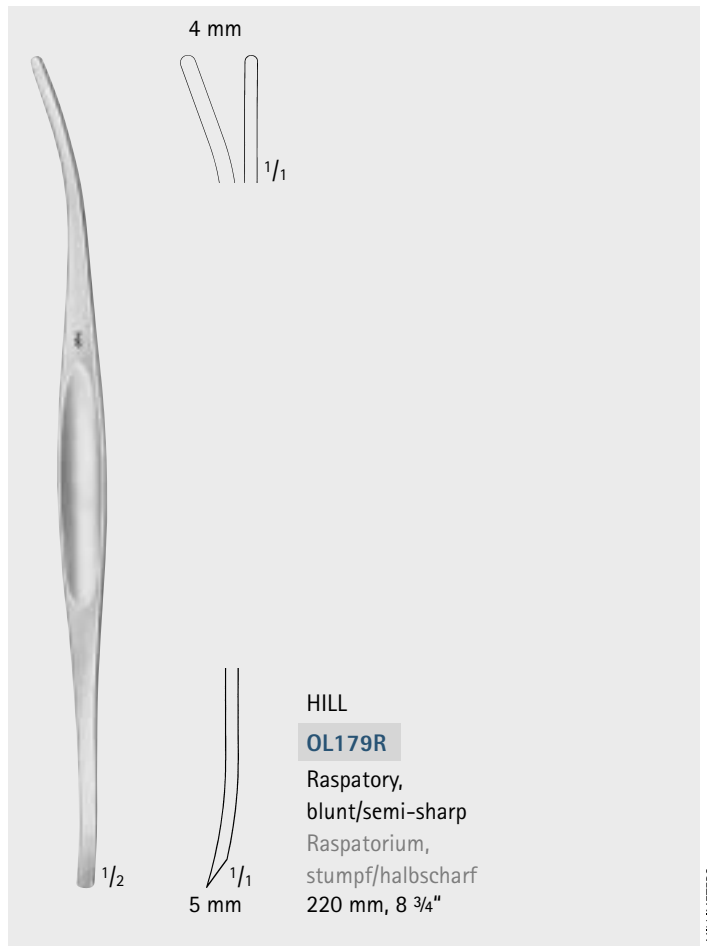

**HILL**  
**OL179R**  
 Raspatory,  
 blunt/semi-sharp  
 Raspatorium,  
 stumpf/halbscharf  
 220 mm, 8 3/4"

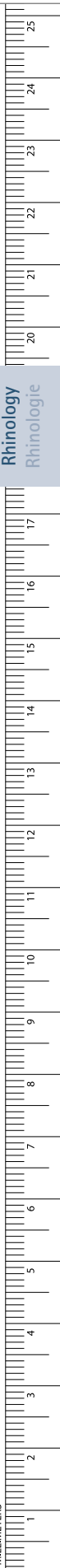

# FESS, Rhinology, Rhinoplasty – FESS, Rhinologie, Septum- und Nasenplastik

## Alar Retractors

### Nasenflügelretraktoren

Rhinology  
Rhinologie

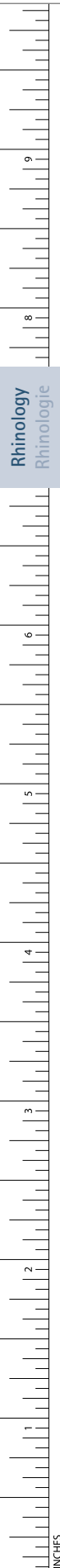

**FOMON**  
**OL202R**  
Alar retractor, 2 prongs,  
blunt/blunt  
Nasenflügelretractor, 2-zinkig,  
stumpf/stumpf  
145 mm, 5 3/4"

**COTTLE**  
**OL203R**  
Alar retractor, 2 prongs,  
blunt/sharp  
Nasenflügelretractor, 2-zinkig,  
stumpf/spitz  
145 mm, 5 3/4"

**COTTLE**  
**OL204R**  
Alar retractor, 2 prongs,  
sharp/blunt  
Nasenflügelretractor, 2-zinkig,  
spitz/stumpf  
145 mm, 5 3/4"

**COTTLE**  
**OL214R**  
Alar retractor, with saw  
and knife guide, 2 prongs,  
blunt/blunt  
Nasenflügelretractor, mit Säge-  
oder Messerführung, 2-zinkig,  
stumpf/stumpf  
200 mm, 7 7/8"

**OL210R**  
Alar retractor  
Nasenflügelhaken  
195 mm, 7 3/4"

# FESS, Rhinology, Rhinoplasty – FESS, Rhinologie, Septum- und Nasenplastik

## Nasal Retractor, Double-ended Retractor

### Nasenretraktor, Doppelhaken



AUFRICHT

**OK099R**

Nasal retractor

Nasenretraktor

175 mm, 6 7/8"

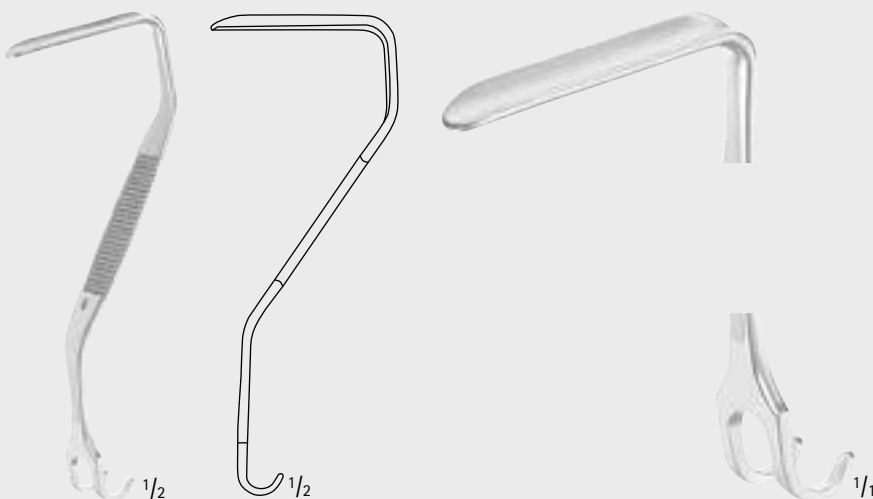

WALTER

**OL218R**

Double-ended retractor

Doppelhaken

130 mm, 5 1/8"

- Please find more hooks in chapter retractors and hooks, starting on page 290
- Weitere Wundhaken, siehe Kapitel Retraktoren und Wundhaken, ab Seite 290

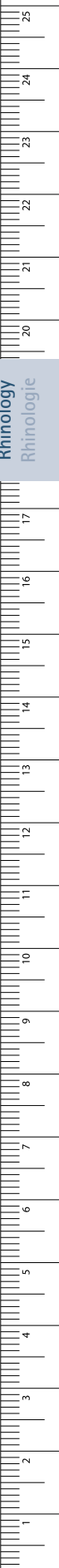

# FESS, Rhinology, Rhinoplasty – FESS, Rhinologie, Septum- und Nasenplastik

## Suction Dissectors, -Raspatories, Dissecting Suction Tube

### Saugdissektoren, -raspatorium, Präpariersauger

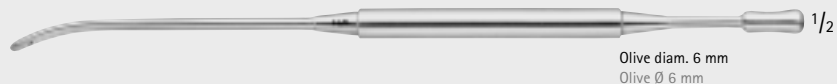
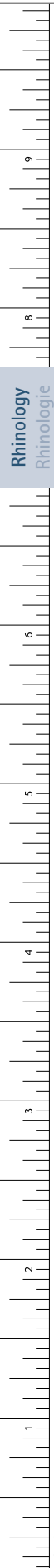

Olive diam. 6 mm  
Olive Ø 6 mm

NEGUS

**OL177R**

Suction dissector  
Saugdissektor  
210 mm, 8 1/4"



Olive diam. 6 - 10 mm  
Olive Ø 6 - 10 mm

GORNEY

**OL168R**

Suction dissector  
Saugdissektor  
180 mm, 7"



Olive diam. 6 - 9 mm  
Olive Ø 6 - 9 mm

Art. No.	Diam. (mm)	Length
Art. Nr.	Ø (mm)	Länge
<b>OL195R</b>	4	200 mm, 7 7/8"
<b>OL196R</b>	5	200 mm, 7 7/8"

Suction raspatory, sharp, bayonet-shaped, with stylet  
Saugraspatorium, scharf, bajonettförmig gebogen, mit Mandarin



Olive diam. 6 - 9 mm  
Olive Ø 6 - 9 mm

LANDOLT

Art. No.	Diam. (mm)	Length
Art. Nr.	Ø (mm)	Länge
<b>GF980R</b>	3.2	200 mm, 7 7/8"

Dissecting suction tube for hypophysectomie and ENT, sharp angled point  
Präpariersauger für Hypophysektomie und HNO, winklige Spitze, scharf

- Please find more suction cannulas in chapter suction instruments, starting on page 525
- Weitere Saugkanülen, siehe Kapitel Sauger, ab Seite 525

# FESS, Rhinology, Rhinoplasty – FESS, Rhinologie, Septum- und Nasenplastik

## Osteotomes, Septum Gouge

### Osteotome, Septum-Hohlmeißel

**OL321R**  
curved left  
links gebogen

**OL322R**  
curved right  
rechts gebogen

**OL323R**  
straight  
gerade

**MASING**  
**OL321R-OL323R**  
Osteotomes, single guarded  
Osteotome  
175 mm, 6 7/8"

**OL338R** **OL339R**

**FOMON**  
**OL338R-OL339R**  
Osteotomes, single guarded  
Osteotome mit einseitig verrundeter Ecke  
170 mm, 6 3/4"

Diam. of tip: 4 mm  
Knopf-Ø: 4 mm

Diam. of tip: 6 mm  
Knopf-Ø: 6 mm

**DO704R** **DO706R**

**CINELLI**  
**DO704R-DO706R**  
Osteotomes for septum  
Nasenseptum Osteotome  
185 mm, 7 1/4"

**OL326R** **OL327R**

**OL328R** **OL329R**

**BALLENGER**  
**OL318R**  
Septum gouge, with notch, straight  
Septum-Hohlmeißel mit Kerbe, gerade  
150 mm, 6"

# FESS, Rhinology, Rhinoplasty – FESS, Rhinologie, Septum- und Nasenplastik

## Osteotomes

### Osteotome

Rhinology  
Rhinologie



COTTLE

Art. No. Art. Nr.	Tip Size (mm) Arbeitsende (mm)	Length Länge
<b>OL294R</b>	4	180 mm, 7"
<b>OL296R</b>	6	180 mm, 7"
<b>OL298R</b>	8	180 mm, 7"
<b>OL299R</b>	10	180 mm, 7"
<b>OL300R</b>	12	180 mm, 7"

with depth markings  
mit Graduierung

COTTLE

Art. No. Art. Nr.	Tip Size (mm) Arbeitsende (mm)	Length Länge
<b>OL301R</b>	4	180 mm, 7"
<b>OL302R</b>	7	180 mm, 7"
<b>OL303R</b>	9	180 mm, 7"
<b>OL304R</b>	12	180 mm, 7"

Chisel Osteotome with depth markings  
mit einseitigem Anschliff und Graduierung

6 mm

COTTLE  
**OL305R**  
with depth markings  
mit Graduierung  
180 mm, 7"

8 mm

COTTLE  
**OL307R**  
Fishtail osteotom, with protected ends  
Fischschwanzosteotom  
180 mm, 7"

2 mm    4 mm    6 mm    7 mm    9 mm    12 mm

**OL270R**    **OL271R**    **OL272R**    **OL273R**    **OL274R**    **OL275R**

COTTLE  
**OL270R-OL275R**  
Osteotomes with depth markings and handle, straight  
Osteotom mit Graduierung und Griffbalken, gerade  
180 mm, 7"

- Please find further bone instruments in chapter bone instruments, starting on page 199
- Weitere Knocheninstrumente siehe Kapitel Knocheninstrumente, ab Seite 199



# FESS, Rhinology, Rhinoplasty – FESS, Rhinologie, Septum- und Nasenplastik

## Gouges, Osteotomes

### Hohlmeißel, Osteotome

6 mm

1/2

**KILLIAN**  
**OL336R**

Septum gouge round cutting edge, bayonet shaped  
Septum-Hohlmeißel mit runder Schneide, bajonettförmig gebogen  
170 mm, 6 3/4"

6 mm

1/2

**KILLIAN-CLAUS**  
**OL335R**

Septum gouge with notch, bayonet shaped  
Septum-Hohlmeißel mit Kerbe, bajonettförmig gebogen  
170 mm, 6 3/4"

2 mm    3 mm    4 mm    7 mm    9 mm

1/2

**WALTER**  
**OL390R-OL394R**

Osteotomes  
Osteotome  
190 mm, 7 1/2"

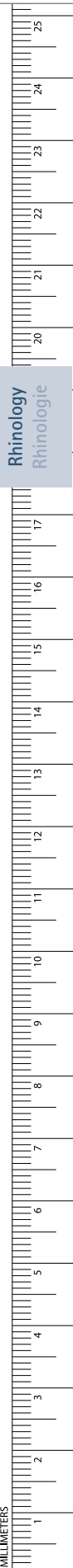

# FESS, Rhinology, Rhinoplasty – FESS, Rhinologie, Septum- und Nasenplastik

## Chisels

### Meißel



Rhinology  
Rhinologie

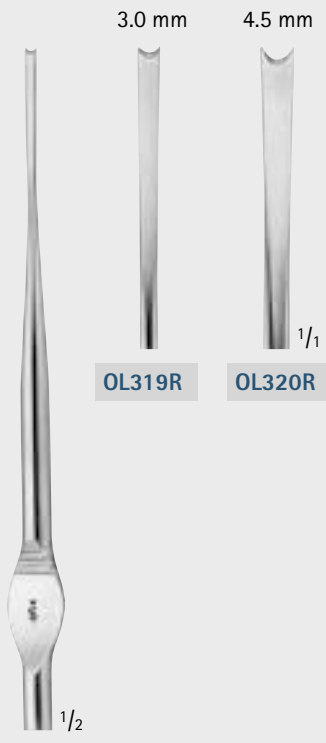

3.0 mm      4.5 mm  
OL319R      OL320R <sup>1/1</sup>

WALTER

**OL319R-OL320R**

Chisels with notch, double guarded

Flachmeißel mit Hohlkehle, Spitzen verrundet

180 mm, 7"

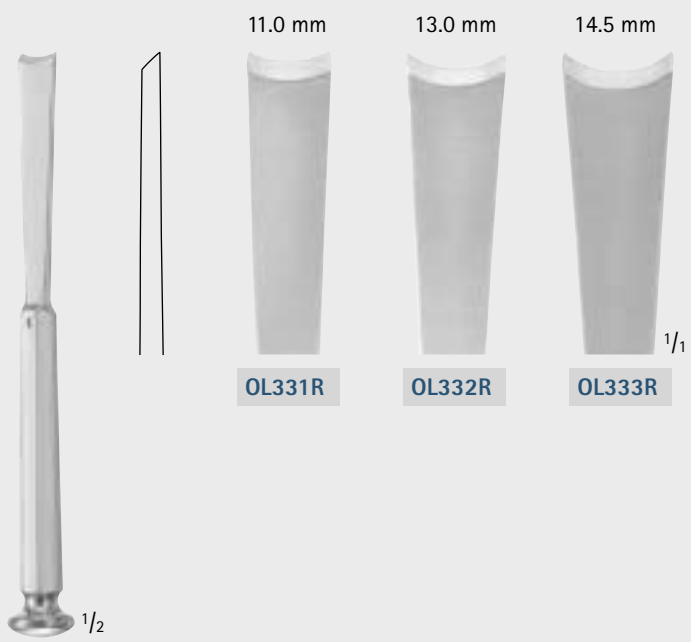

11.0 mm      13.0 mm      14.5 mm  
OL331R      OL332R      OL333R <sup>1/1</sup>

MC INDOE

**OL331R-OL333R**

Chisels with notch, double guarded

Meißel mit Hohlkehle, Spitzen verrundet

155 mm, 6 1/8"

## FESS, Rhinology, Rhinoplasty – FESS, Rhinologie, Septum- und Nasenplastik

## Bone Crusher

## Knochen-Knorpelquetsche

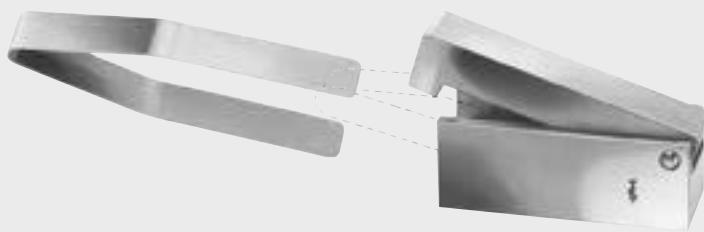
**OL460R**

Bone crusher, for preparation of cartilage  
implant material, complete with clamp

Knochen-Knorpelquetsche mit Metallklammer  
zum Entnehmen der Knochen-Knorpeltrümmer

**OL461R**

Bone crusher, for pieces up to 40 mm diameter

Knochen-Knorpelquetsche für Stücke bis zu 40 mm Durchmesser

# FESS, Rhinology, Rhinoplasty – FESS, Rhinologie, Septum- und Nasenplastik

## Micro Bone Mill, Bone Mill Cleaners

### Mikro-Knochenmühle, Reinigungsinstrumente

Rhinology  
Rhinologie

#### ERGOPLANT Micro Bone-Mill

- small and handy
- interchangeable cutting disks
- cutting disks available for finer or coarser bone particles
- easy to clean due special cleaning instruments
- easy mounting and demounting
- maximum bone yield requires less bone harvesting

#### ERGOPLANT Mikro Knochenmühle

- kompakt und handlich
- auswechselbare Schneideplatten
- Schneideplatten für feine oder grobe Knochenpartikel erhältlich
- leicht zu reinigen durch spezielle Reinigungsinstrumente
- einfache Montage / Demontage
- maximale Knochenausbeute, dadurch weniger Knochenentnahme nötig

#### ■ ERGOPLANT



#### DX801R

Micro bone mill  
(delivered with coarse  
cutting disk DX803R)  
Mikro-Knochenmühle  
(Lieferung mit grober  
Schneideplatte DX803R)

#### ■ ERGOPLANT

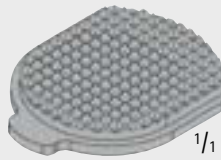

#### DX802R

Cutting disc for DX801R, fine  
Schneideplatte für DX801R, fein

#### ■ ERGOPLANT

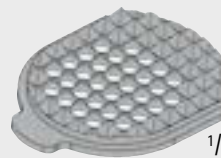

#### DX803R

Cutting disc for DX801R, coarse  
Schneideplatte für DX801R, grob

#### ■ ERGOPLANT



#### DX810R

Bone mill cleaner  
for DX802R, fine  
Reinigungsinstrument  
für DX802R, fein  
195 mm, 7 3/4"

#### ■ ERGOPLANT



#### DX811R

Bone mill cleaner  
for DX802R, coarse  
Reinigungsinstrument  
für DX802R, grob  
195 mm, 7 3/4"

## FESS, Rhinology, Rhinoplasty – FESS, Rhinologie, Septum- und Nasenplastik

## Micro Bone Mill Kit

## Mikro-Knochenmühle Kit

**DX800**

Aesculap® Micro Bone Mill Kit,  
consisting of:

- DX801R** 1 ERGOPLANT Micro bone-mill  
(incl. DX803R cutting disk, coarse)
- DX802R** 1 ERGOPLANT Cutting disk, fine
- DX810R** 1 ERGOPLANT Bone mill-cleaner, fine
- DX811R** 1 ERGOPLANT Bone mill-cleaner, coarse
- JF284R** 1 Tray (274 x 172 x 60 mm)  
with storage aid for micro bone-mill,  
suitable for dental container JN095
- TE888** 1 Packing stencil (only available for DX800)

**DX800**

Aesculap® Mikro-Knochenmühlen Kit,  
bestehend aus:

- DX801R** 1 ERGOPLANT Mikro-Knochenmühle  
(inkl. DX803R Schneideplatte, grob)
- DX802R** 1 ERGOPLANT Schneideplatte, fein
- DX810R** 1 ERGOPLANT Knochenmühlenreiniger, fein
- DX811R** 1 ERGOPLANT Knochenmühlenreiniger, grob
- JF284R** 1 Siebtray (274 x 172 x 60 mm)  
mit Lagerung für Knochenmühlen Set,  
passend in Dental Container JN095
- TE888** 1 Packschablone (nur für DX800 erhältlich)

# FESS, Rhinology, Rhinoplasty – FESS, Rhinologie, Septum- und Nasenplastik

## Septum Straightening Forceps

### Septumzangen



Rhinology  
Rhinologie



ASH  
**OL470R**  
220 mm, 8 3/4"

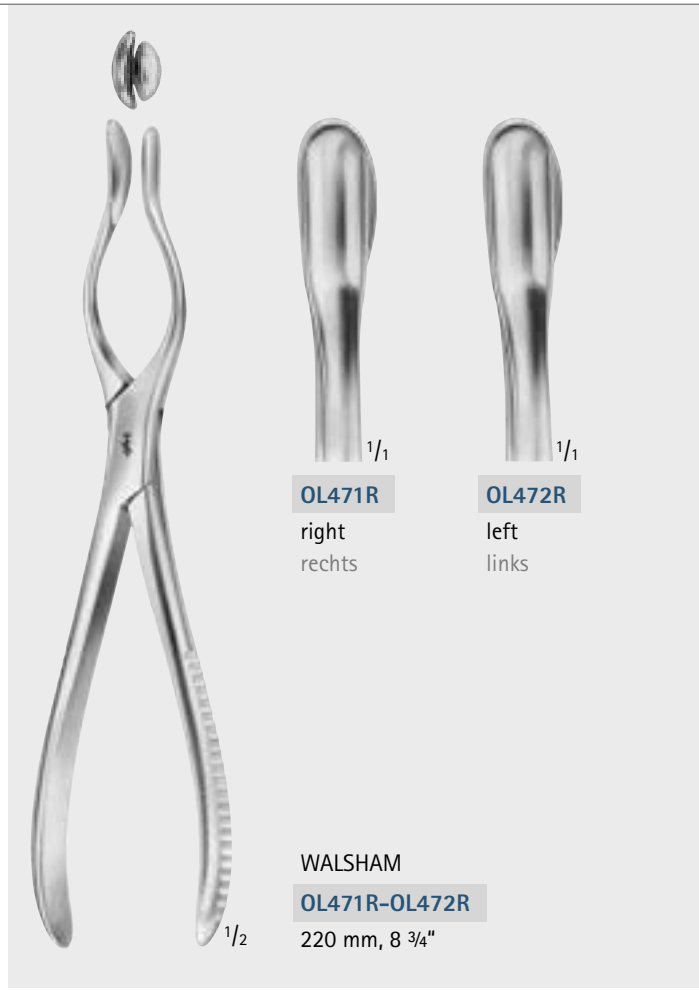

**OL471R**  
right  
rechts

**OL472R**  
left  
links

WALSHAM  
**OL471R-OL472R**  
220 mm, 8 3/4"



COTTLE-WALSHAM  
**OL473R**  
with aseptic lock  
mit aseptischem Schluss  
220 mm, 8 3/4"

# FESS, Rhinology, Rhinoplasty – FESS, Rhinologie, Septum- und Nasenplastik

Cartilage Morselizer Forceps, Nasal Fracture-, Septum Elevator, Columella Clamp, Forceps

Knorpelritzzange, Nasenfrakturaufrichter, Columella-Klemme, Fixierpinzette



**OL474R**

Cartilage morselizer forceps with removeable guard, converts cartilage into a membranous-like structure, which permits repositioning of the septum to midline

Knorpelritzzange mit abnehmbarem einseitigem Schutz für rechts und links sowie ohne Schutz für ein gleichzeitiges Einritzen beider Knorpelseiten  
200 mm, 7 7/8"



**BOIES**

**OL477R**

Nasal fracture elevator, a strong instrument with blunt edges for elevating nasal fractures oval  
Nasenfrakturaufrichter, ovale Form, mit stumpfen Kanten  
180 mm, 7"



**GOLDMANN**

**OL479R**

Nasal fracture elevator, rounded (displacer)  
Nasenfrakturaufrichter, runde Form  
200 mm, 7 7/8"



**COTTLE**

**OL010R**

Columella clamp, with fixation bearings and adjusting screw  
Columella-Klemme, mit feststehenden Fixierrollen und Stellschraube  
100 mm, 4"

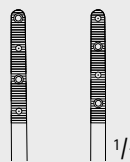

toothed and serrated  
gezahnt und gerieft

**COTTLE**

**OL011R**

Forceps  
Fixierpinzette  
140 mm, 5 1/2"

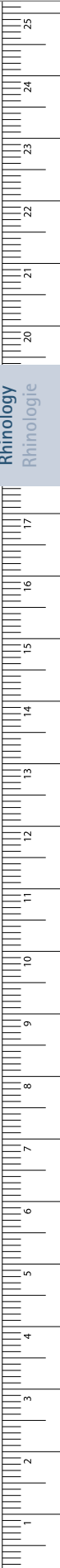

# FESS, Rhinology, Rhinoplasty – FESS, Rhinologie, Septum- und Nasenplastik

## Nasal Polypus Snare, Wire Loops For Nasal Snares

### Nasenpolypenschnürer, Schlingen für Nasenpolypenschnürer

Rhinology  
Rhinologie

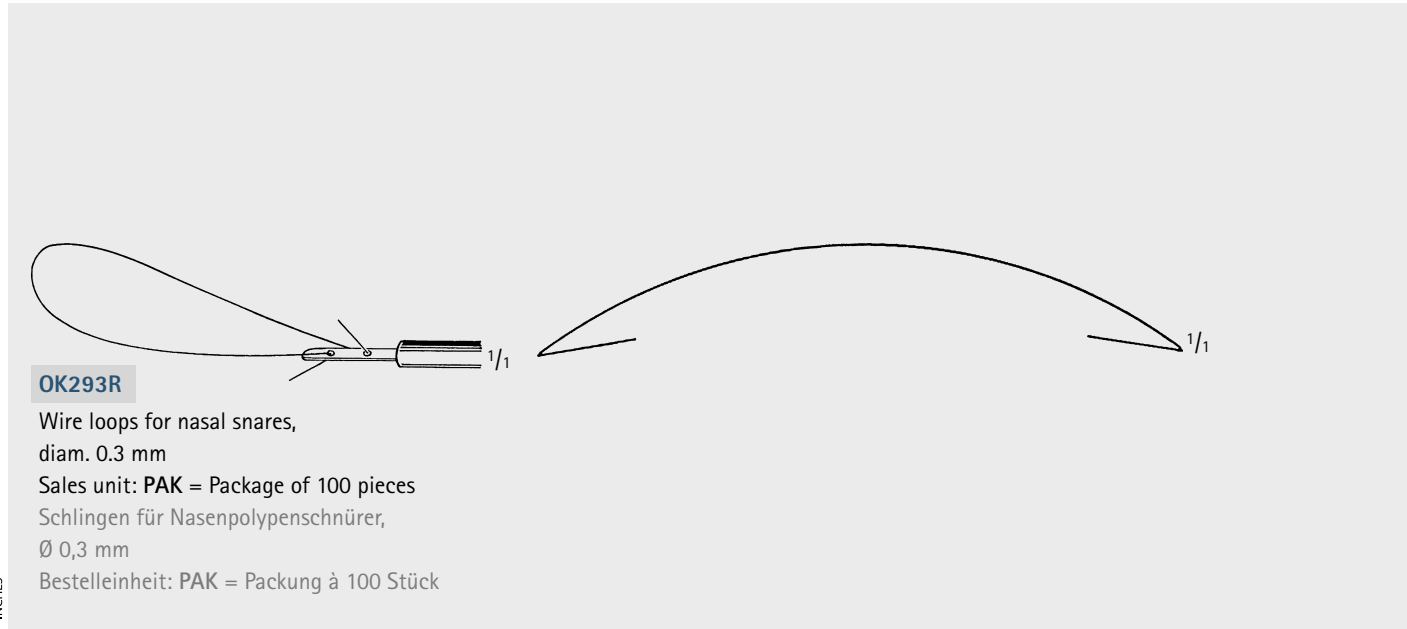
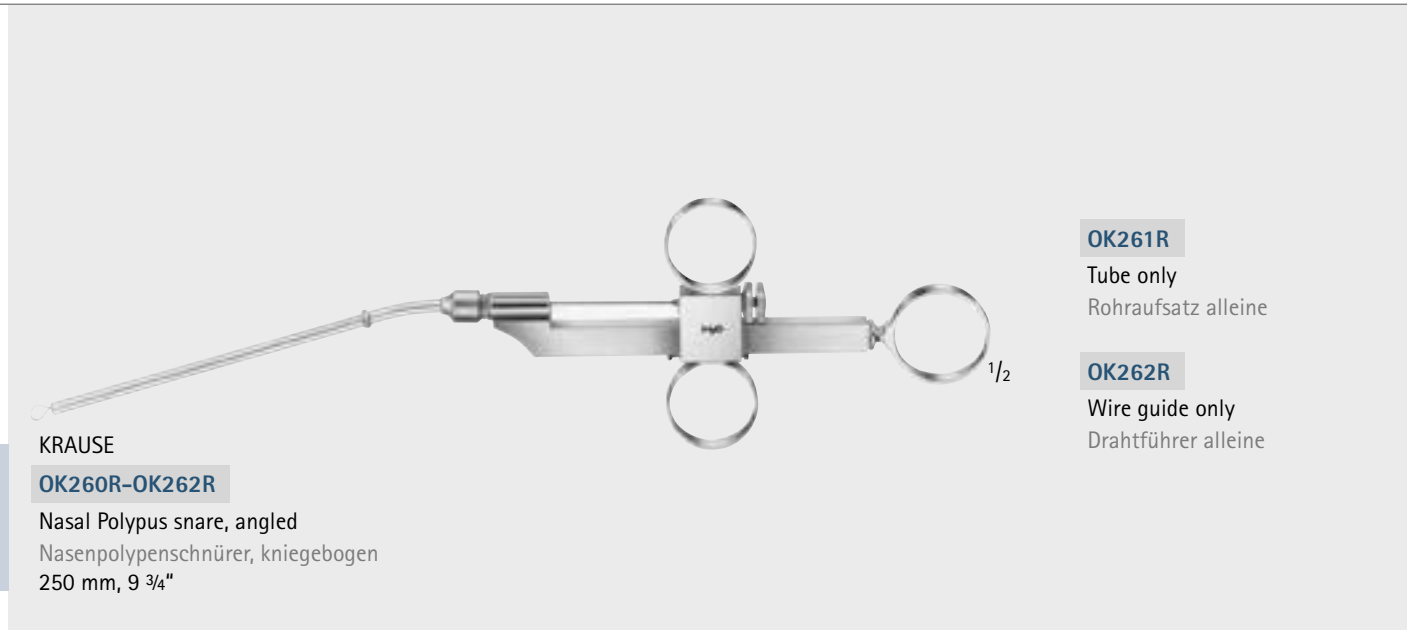
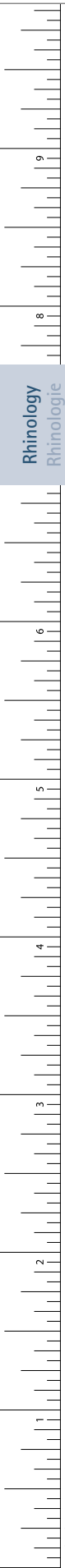



# FESS, Rhinology, Rhinoplasty – FESS, Rhinologie, Septum- und Nasenplastik

## Derma Punch, Dermatomes, Spare Blade, Skin Straightening Plate

### Hautstanze, Dermatom, Ersatzklingen, Spannplatte



KEYES

**OL670R**

Derma punch, complete with 5 interchangeable tips, handle and rack

Hautstanze, komplett, mit 5 auswechselbaren Aufsätzen, Griff und Gestell



SCHINK

**BA706R**

Dermatome, adjustable from 0.1 to 2.0 mm, complete, with 1 interchangeable blade and 2 skin straightening plates

Dermatom, einstellbar von 0,1 bis 2,0 mm, komplett, mit 1 auswechselbaren Klinge und 2 Spannplatten  
300 mm, 11 3/4"



**BA708R**

Spare blade only  
Ersatzklinge allein



**BA709R**

Skin straightening plate only  
Spannplatte allein



SILVER

**BA715R**

Skin graft knife without blade  
Dermatom, ohne Klinge  
190 mm, 7 1/2"

SILVER

**BA716SU**

Spare blade, sterile

Sales unit:

PAK = Package of 5 pieces

Ersatzklinge, steril

Bestelleinheit:

PAK = Packung à 5 Stück  
40 mm, 1 1/2"

Rhinology  
Rhinologie

MILLIMETERS

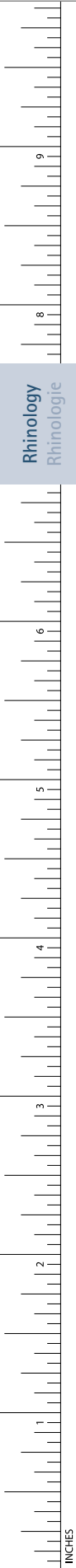

Rhinology  
Rhinologie

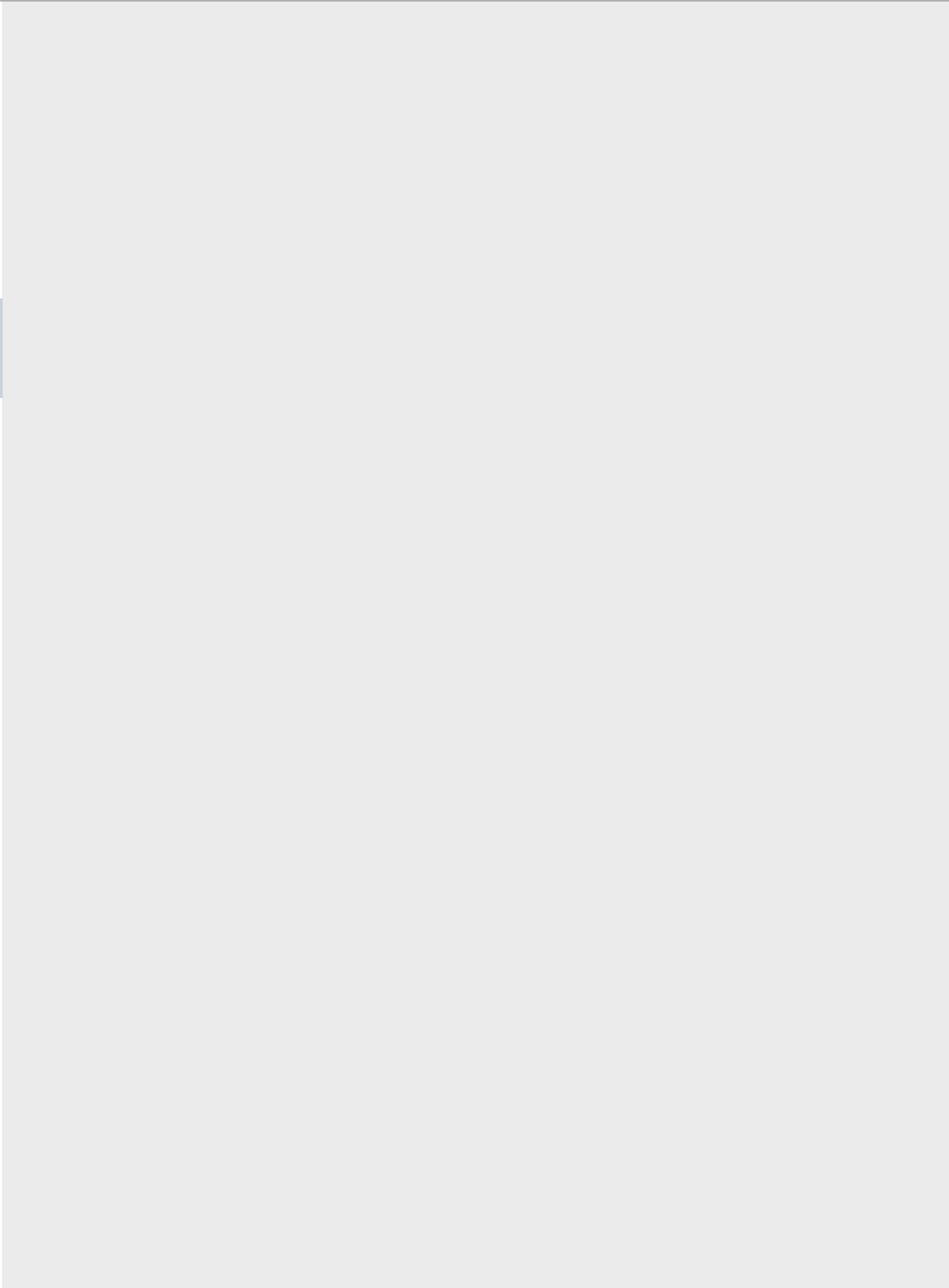

Adenoidectomy, Tonsillectomy  
Adenotomie, Tonsillektomie



# Adenoidectomy, Tonsillectomy – Adenotomie, Tonsillektomie

## Tongue Depressors

### Zungenspatel



Adenotomy  
Adenotomie

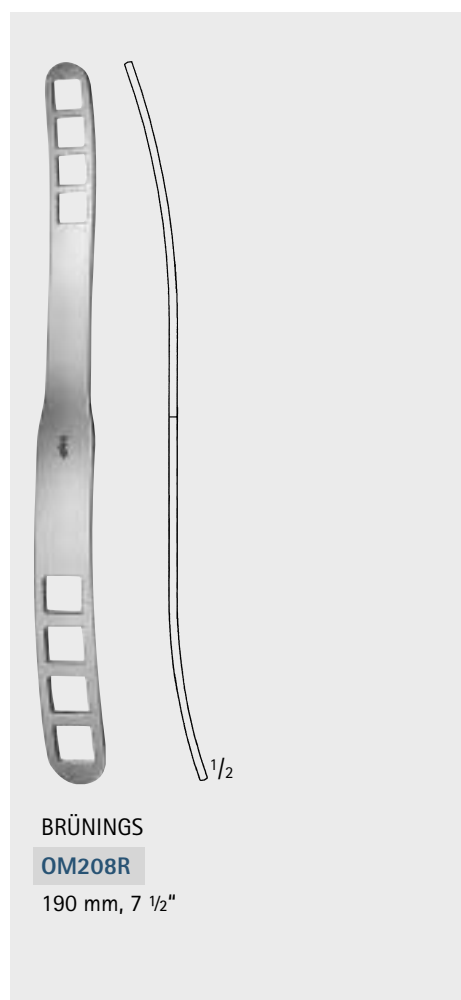
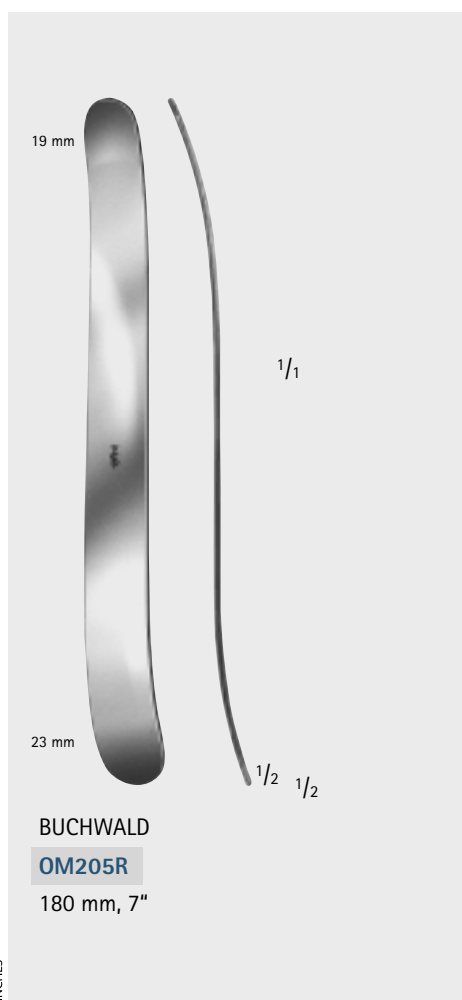
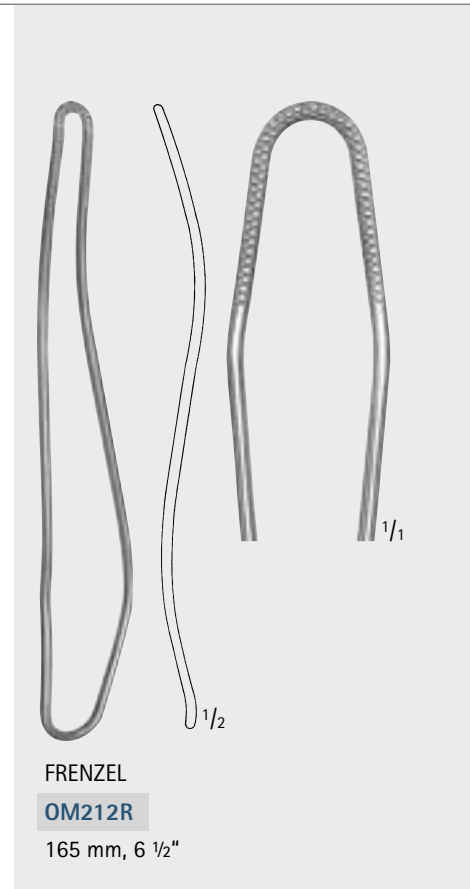
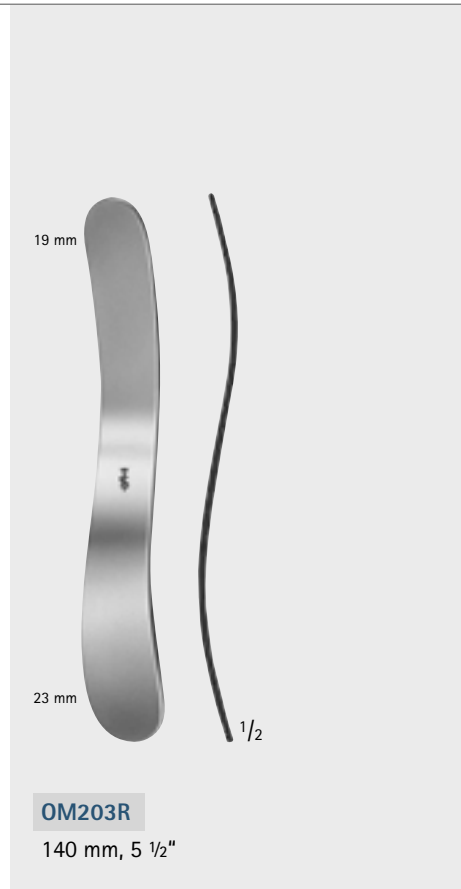
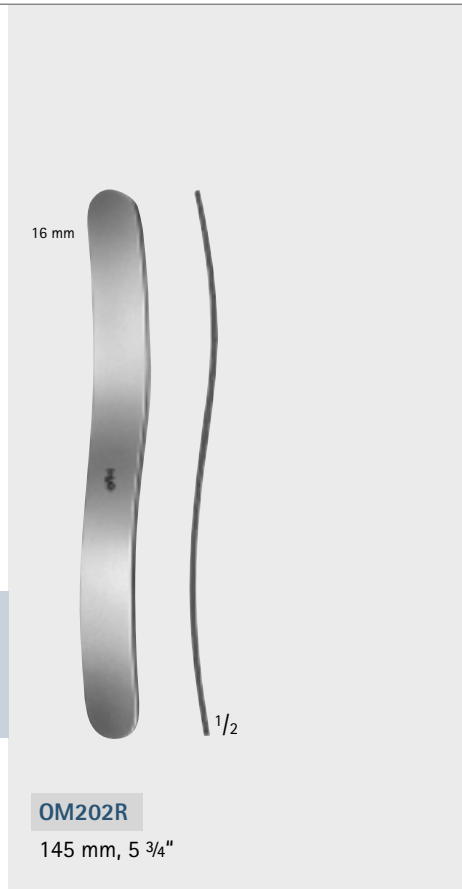

# Adenoidectomy, Tonsillectomy – Adenotomie, Tonsillektomie

Tongue Depressors, Tongue Forceps

Zungenspatel, Zungenzange



1/2

LACK

Art. No.	Width (mm)
Art. Nr.	Breite (mm)

OM220R	13.0
--------	------

OM221R	19.0
--------	------

OM222R	22.0
--------	------

curved  
gebogen



1/2



OM236R



1/1

OM237R

WEDER

OM236R-OM237R

fenestrated  
gefenstert  
125 mm, 5"

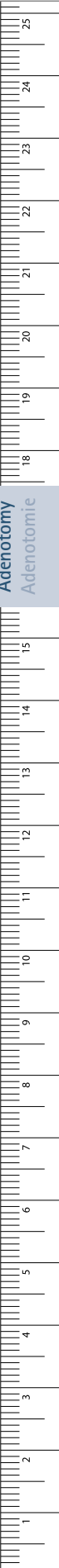

# Adenoidectomy, Tonsillectomy – Adenotomie, Tonsillektomie

## Tongue Retractors

## Zungenretraktoren



Adenotomy  
Adenotomie



HARTMANN  
**OM230R**  
with fenestrated handle  
mit Gittergriff  
150 mm, 6"



TOBOLD  
**OM235R**  
160 mm, 6 1/4"

### ■ ERGOPLANT



**DX105R**  
190 mm, 7 1/2"

# Adenoidectomy, Tonsillectomy – Adenotomie, Tonsillektomie

Mouth Gags

Mundsperrerr



HEISTER

**OM030R**

130 mm, 5 1/8"



MOLT

**OM038R**

for children  
für Kinder  
100 mm, 4"



DOYEN-COLLIN

**OM040R**

120 mm, 4 3/4"

**TA009706**

Spare silicone tube only, latex-free  
Ersatz-Silikonschlauch, Latex-frei  
Length/Länge: 1 m



DOYEN-JANSEN

**OM041R**

140 mm, 5 1/2"

**TA005771**

Spare silicone tube only,  
latex-free  
Ersatz-Silikonschlauch,  
Latex-frei  
Length/Länge: 1 m

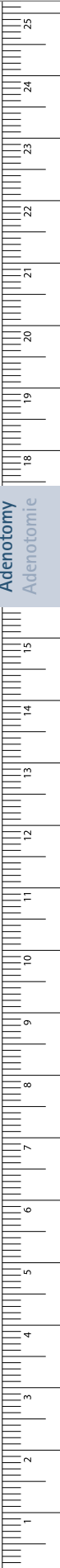

# Adenoidectomy, Tonsillectomy – Adenotomie, Tonsillektomie

## ERGOPLANT Mouth Wedges, Chain

### ERGOPLANT Mundkeile, Kette

- The mouth wedges are particularly advantageous for longer implantations and also provide support for the patient.
- Die Mundkeile sind besonders bei längeren Implantationen von Vorteil und unterstützen zudem den Patienten.



**DX113–DX115**

Sales unit:  
**PAK = Package of 2 pieces**  
 Bestelleinheit:  
 PAK = Packung à 2 Stück



**DX120R**

Chain with clip lock for DX113–DX115  
 Kette mit Klemmverschluss für DX113–DX115  
 450 mm, 17 3/4"



**DX113**

Silicone mouth wedge  
 Size: S  
 Silikon-Mundkeil  
 Größe: S

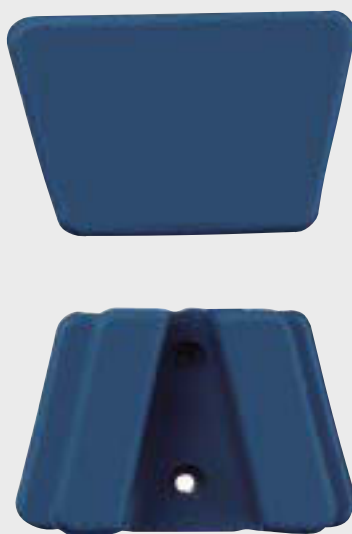

**DX114**

Silicone mouth wedge with metal core  
 Size: M  
 Silikon-Mundkeil mit Metallkern  
 Größe: M



**DX115**

Silicone mouth wedge with metal core  
 Size: L  
 Silikon-Mundkeil mit Metallkern  
 Größe: L

Adenotomy  
Adenotomie



# Adenoidectomy, Tonsillectomy – Adenotomie, Tonsillektomie

Mouth Gags

Mundsperrer



FERGUSSON-ACKLAND

**OM044R**

145 mm, 5 3/4"



DENHARDT

**OM047R**

125 mm, 5"



ROSER-KÖNIG

**OM048R**

160 mm, 6 1/4"



ROSER-KÖNIG

**OM049R**

185 mm, 7 1/4"

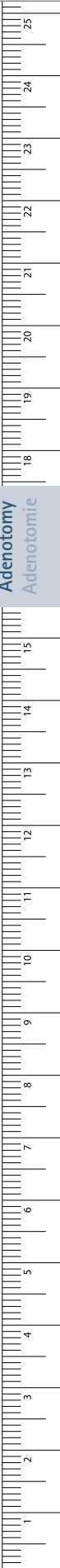

# Adenoidectomy, Tonsillectomy - Adenotomie, Tonsillektomie

Mouth Gag

Mundsperrerr

Adenotomy  
Adenotomie

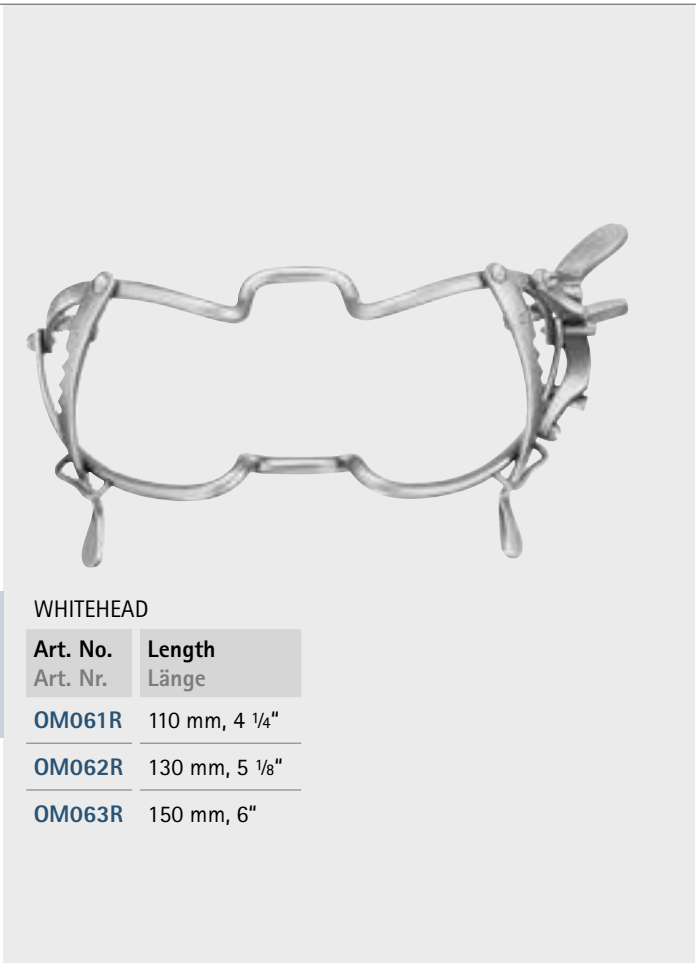
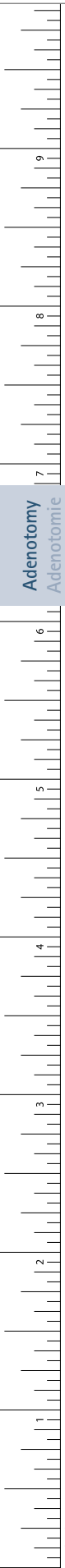

**WHITEHEAD**

Art. No.	Length
Art. Nr.	Länge
OM061R	110 mm, 4 1/4"
OM062R	130 mm, 5 1/8"
OM063R	150 mm, 6"

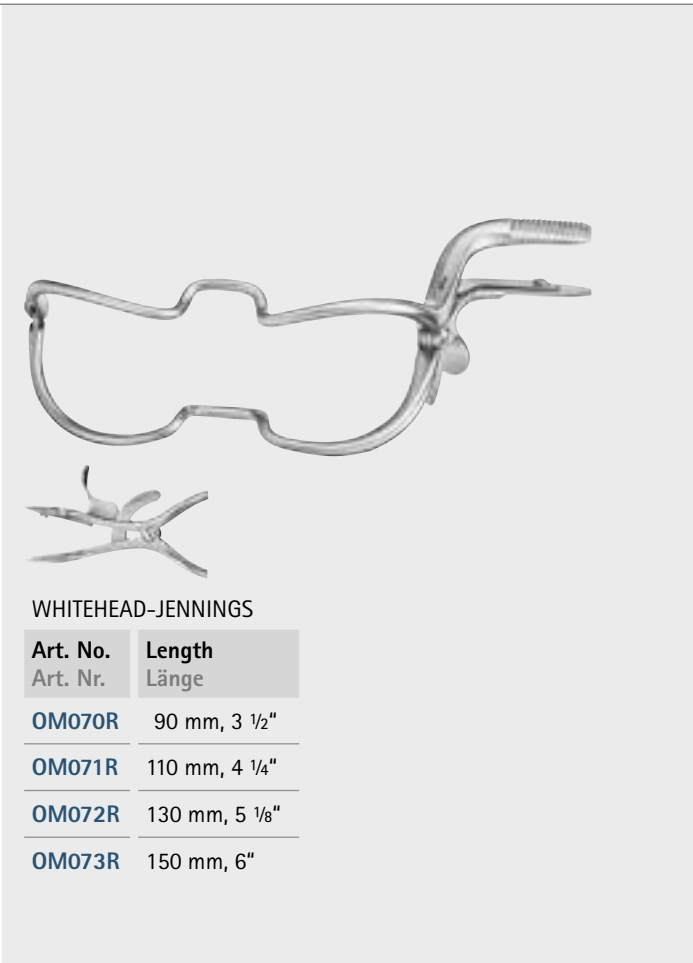

**WHITEHEAD-JENNINGS**

Art. No.	Length
Art. Nr.	Länge
OM070R	90 mm, 3 1/2"
OM071R	110 mm, 4 1/4"
OM072R	130 mm, 5 1/8"
OM073R	150 mm, 6"

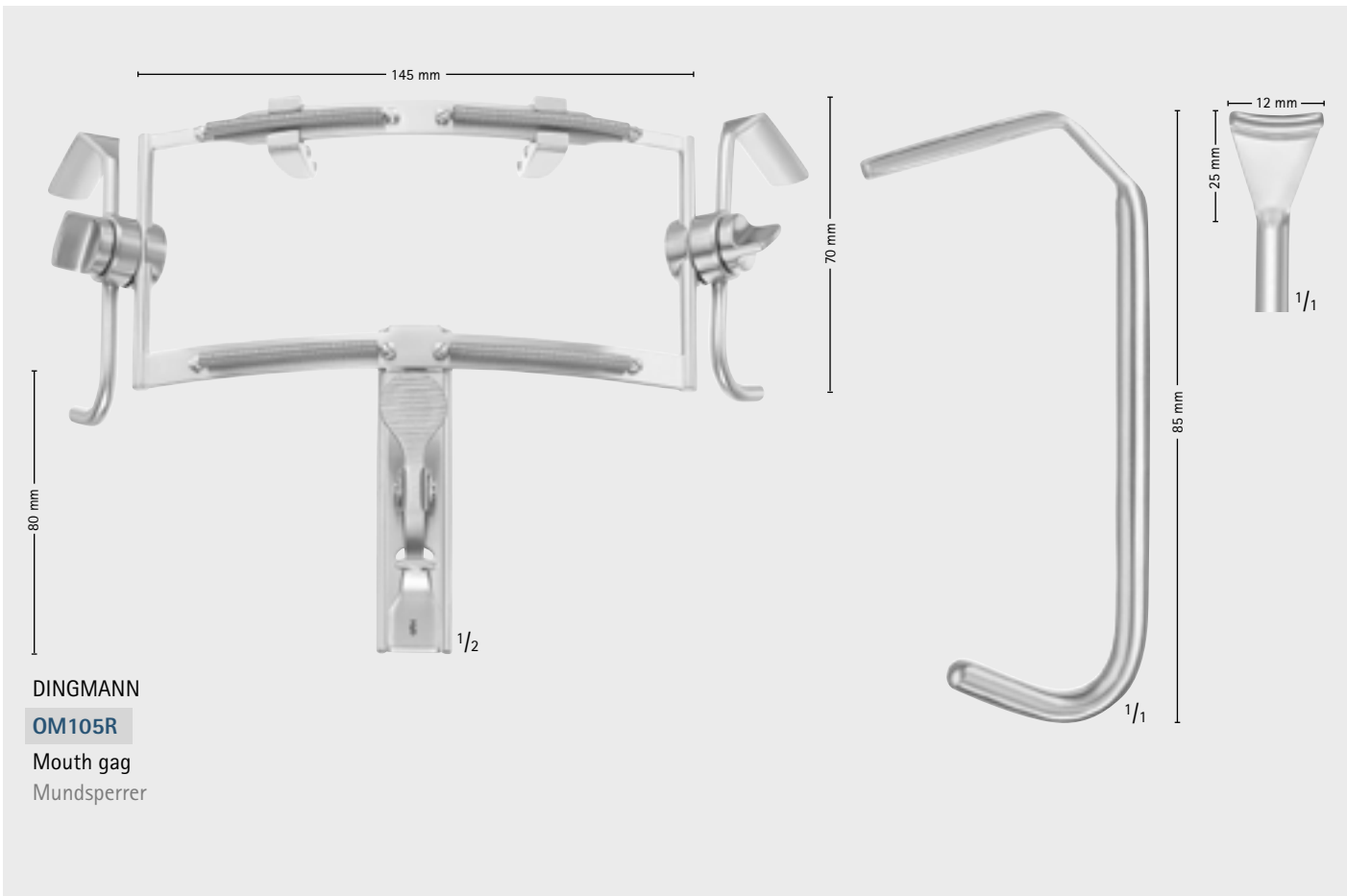

**DINGMANN**

**OM105R**  
Mouth gag  
Mundsperrerr

145 mm

80 mm

70 mm

85 mm

25 mm

12 mm

1/2

1/1

# Adenoidectomy, Tonsillectomy – Adenotomie, Tonsillektomie

Frame for Mouth Gag, Palate Plate, Silicone Insert  
 Bügel für Mundsperrer, Gaumenplatte, Silikoneinlagen

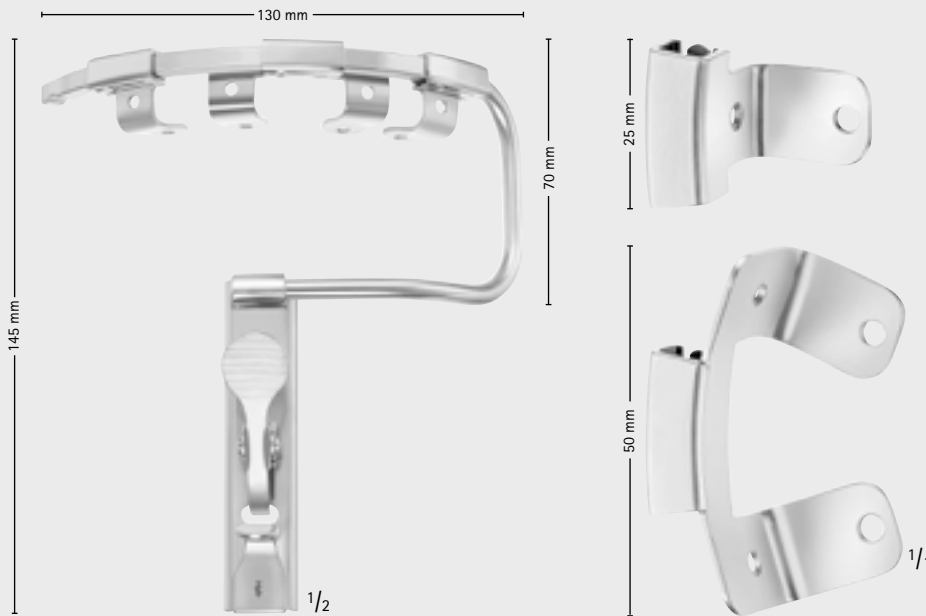

DAVIS-MEYER

**OM169R**

Frame only, with 2 single bites and 1 double bite, with interchangeable silicone inserts, suitable for all tongue depressors as shown on pages 127-133

Bügel, allein, mit 2 Einzelgebissplatten und 1 Doppelgebissplatte mit auswechselbaren Silikoneinlagen, passend für alle Zungenspatel, siehe Seite 127-133



**OM179R**

Palate plate to use with OM169R, for toothless patients

Gaumenplatte zu Bügel OM169R, für zahnlose Patienten



MC IVOR

**OM104R**

Frame only, suitable for all tongue depressors as shown on pages 127-133

Bügel, allein, passend für alle Zungenspatel, siehe Seite 127-133

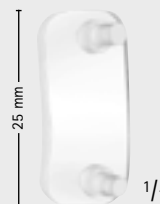

**OM170**

Silicone insert only for OM104R, OM116R, OM118R, OM119R, OM169R

Silikoneinlagen allein, für OM104R, OM116R, OM118R, OM119R, OM169R

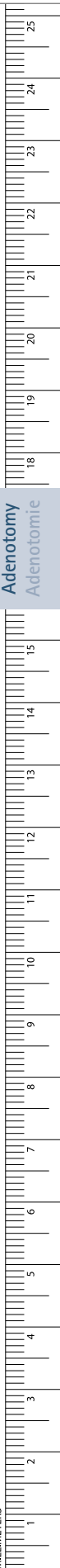

Adenotomie  
 Adenotomie

# Adenoidectomy, Tonsillectomy – Adenotomie, Tonsillektomie

## Frame for Mouth Gag

### Bügel für Mundsperrerr



Adenotomy  
Adenotomie

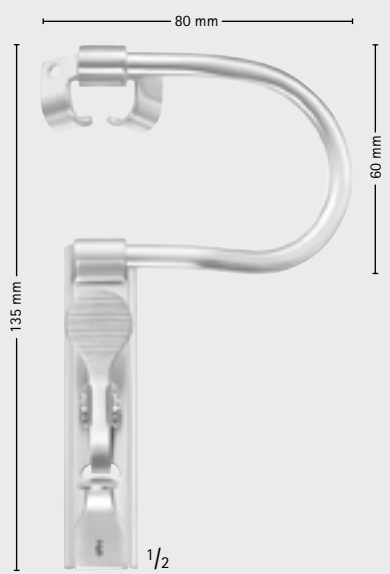

**DAVIS-BOYLE**  
**OM118R**

Frame only, for children, with interchangeable silicone inserts, suitable for all tongue depressors as shown on pages 127-133  
Bügel, allein, für Kinder, mit auswechselbaren Silikon-einlagen passend für alle Zungenspatel, siehe Seite 127-133

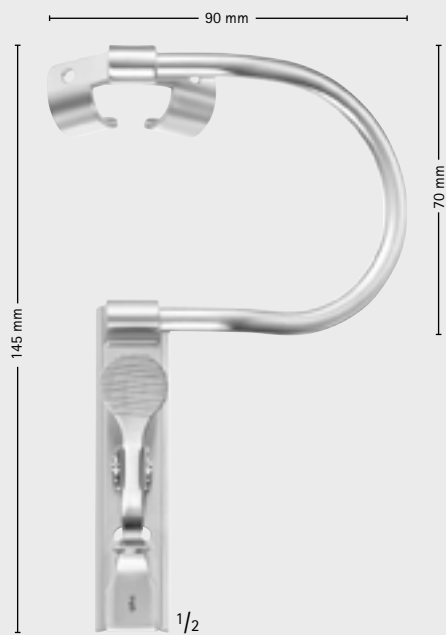

**DAVIS-BOYLE**  
**OM119R**

Frame only, for adolescents, with interchangeable silicone inserts, suitable for all tongue depressors as shown on pages 127-133  
Bügel, allein, für Jugendliche, mit auswechselbaren Silikon-einlagen passend für alle Zungenspatel, siehe Seite 127-133



**DAVIS-BOYLE**  
**OM116R**

Frame only, for adults, with interchangeable silicone inserts, suitable for all tongue depressors as shown on pages 127-133  
Bügel, allein, für Erwachsene, mit auswechselbaren Silikon-einlagen passend für alle Zungenspatel, siehe Seite 127-133

## Adenoidectomy, Tonsillectomy – Adenotomie, Tonsillektomie

Tongue Blades

Zungenspatel



## RUSSEL-DAVIS

Art. No.	Blade size (mm)
Art. Nr.	Blattgröße (mm)
OM171R	29 x 67
OM172R	33 x 75
OM173R	38 x 85
OM174R	40 x 92
OM175R	46 x 100

A groove holds the endotracheal tube, protects it from moving, kinking or closure by teeth, suitable for OM104R, OM105R, OM116R, OM118R, OM119R, OM169R

Mit Mittelrinne für Intubationstubus, passend für OM104R, OM105R, OM116R, OM118R, OM119R, OM169R

# Adenoidectomy, Tonsillectomy – Adenotomie, Tonsillektomie

## Tongue Blades

## Zungenspatel

Adenotomy  
Adenotomie



RUSSEL-DAVIS

Art. No.	Blade size (mm)
Art. Nr.	Blattgröße (mm)
OM176R	18 x 57
OM177R	22 x 67
OM178R	25 x 75

Narrow pattern, with groove for endotracheal tubes, suitable for OM104R, OM105R, OM116R, OM118R, OM119R, OM169R

Extra schmale Modelle, allein, mit Mittelrinne für Intubationstubus, passend für OM104R, OM105R, OM116R, OM118R, OM119R, OM169R

## Adenoidectomy, Tonsillectomy – Adenotomie, Tonsillektomie

Tongue Blades

Zungenspatel



GAST

Art. No.	Blade size (mm)
Art. Nr.	Blattgröße (mm)
OM181R	28 x 64
OM182R	34 x 74
OM183R	38 x 87

only, with groove for endotracheal tubes and lateral slot,  
suitable for OM104R, OM105R, OM116R, OM118R,  
OM119R, OM169R

allein, mit Mittelrinne für Intubations-Katheter und  
seitlichem Einschnitt, passend für OM104R, OM105R,  
OM116R, OM118R, OM119R, OM169R

Adenotomie  
Adenotomie

MILLIMETERS

# Adenoidectomy, Tonsillectomy – Adenotomie, Tonsillektomie

## Tongue Blades

### Zungenspatel

Adenotomy  
Adenotomie



OM101R



OM102R



OM103R



MC IVOR

Art. No.	Blade size (mm)
Art. Nr.	Blattgröße (mm)
OM101R	25 x 55
OM102R	25 x 62
OM103R	25 x 75

only, suitable for OM104R, OM105R, OM116R,  
OM118R, OM119R, OM169R  
allein, passend für OM104R, OM105R, OM116R,  
OM118R, OM119R, OM169R



## Adenoidectomy, Tonsillectomy – Adenotomie, Tonsillektomie

Tongue Blades

Zungenspatel



## DAVIS-BOYLE

Art. No. Art. Nr.	Blade size (mm) Blattgröße (mm)	Description Beschreibung
OM111R	19 x 25	without anesthesia channel ohne Insufflationsrohr
OM112R	25 x 62	with anesthesia channel mit Insufflationsrohr
OM113R	25 x 75	with anesthesia channel mit Insufflationsrohr
OM114R	25 x 92	with anesthesia channel mit Insufflationsrohr
OM115R	25 x 108	with anesthesia channel mit Insufflationsrohr

only, suitable for OM104R, OM105R, OM116R,  
OM118R, OM119R, OM169R  
allein, passend für OM104R, OM105R, OM116R,  
OM118R, OM119R, OM169R

Adenotomie  
Adenotomie

MILLIMETERS

# Adenoidectomy, Tonsillectomy – Adenotomie, Tonsillektomie

Tongue Blades

Zungenspatel

Adenotomy  
Adenotomie



OM154R



OM155R



OM157R



OM156R



OM158R

DOUGHTY

Art. No.	Blade size (mm)
Art. Nr.	Blattgröße (mm)
OM154R	65
OM155R	75
OM156R	90
OM157R	102
OM158R	115

with slot for endotracheal tubes for use with  
OM116R, OM118R, OM119R DAVIS-BOYLE frames  
mit Mittelrinne für Intubationstubus, passend zu  
OM116R, OM118R, OM119R DAVIS-BOYLE Bügeln

## Adenoidectomy, Tonsillectomy – Adenotomie, Tonsillektomie

Tongue Blades

Zungenspatel

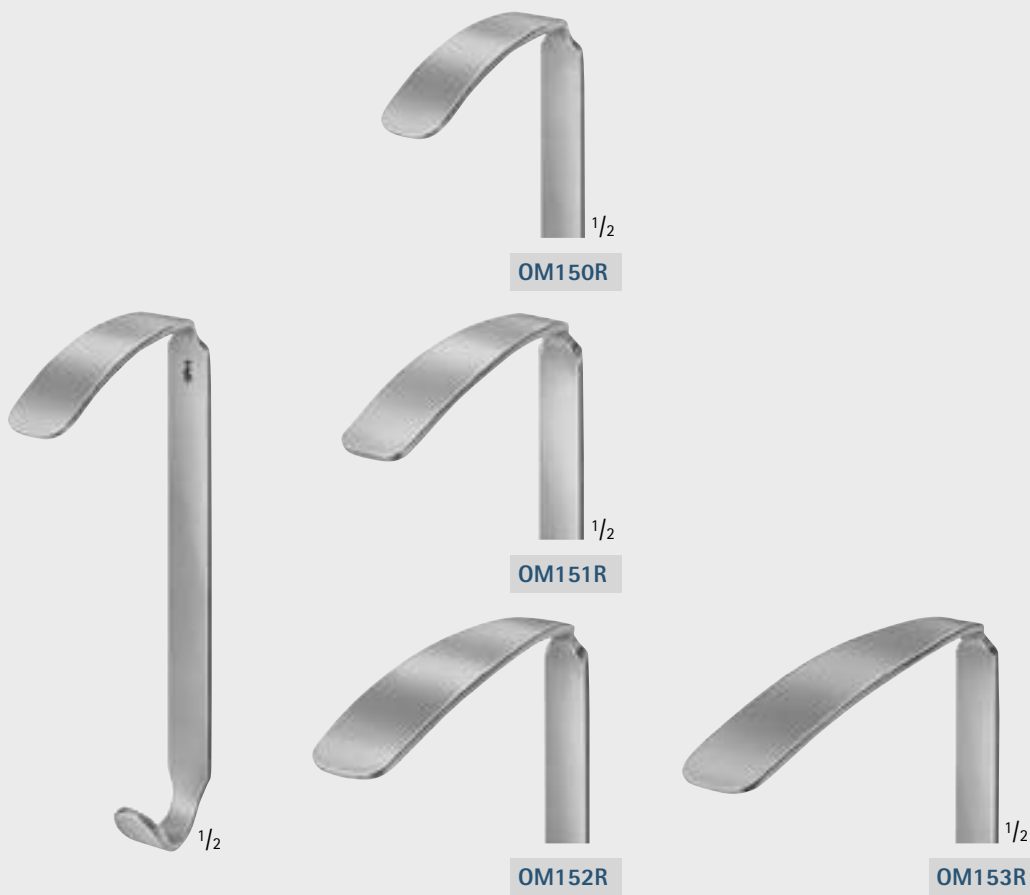

Art. No.	Blade size (mm)
Art. Nr.	Blattgröße (mm)
OM150R	65
OM151R	75
OM152R	90
OM153R	102

plain for use with OM116R, OM118R, OM119R  
 DAVIS-BOYLE frames  
 allein, passend zu OM116R, OM118R, OM119R  
 DAVIS-BOYLE Bügeln

Adenotomie  
Adenotomie

MILLIMETERS

# Adenoidectomy, Tonsillectomy – Adenotomie, Tonsillektomie

## Chest Support with Accessories

### Bruststütze mit Zubehör

Adenotomy  
Adenotomie



NEGUS

**OM185R**

Chest Support, for use with tongue blades and mouth gag

Bruststütze

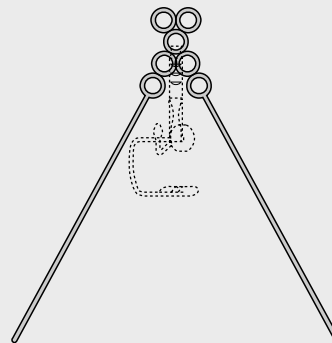

DRAFFIN

**OM186R**

Bipod fitted with 4 rings for varying heights

Rahmen mit 4 Stufen zur Höheneinstellung

480 mm, 18 7/8"

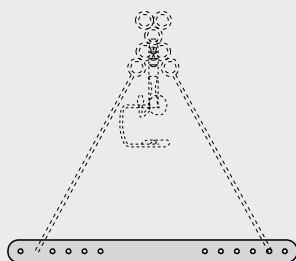

MAGAURAN

**OM187R**

Plate for holding Draffin bipod

Platte zum Befestigen des

Draffin-Rahmens

405 mm, 16"

INCHES

# Adenoidectomy, Tonsillectomy – Adenotomie, Tonsillektomie

## Organ- and Tissue Grasping Forceps

### Hakenfazzzangen, Arterienfazzzange

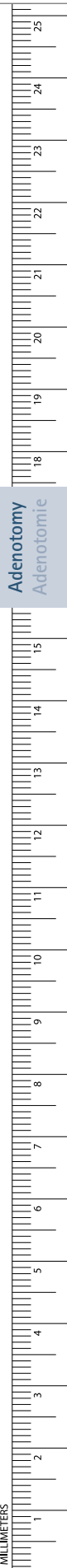
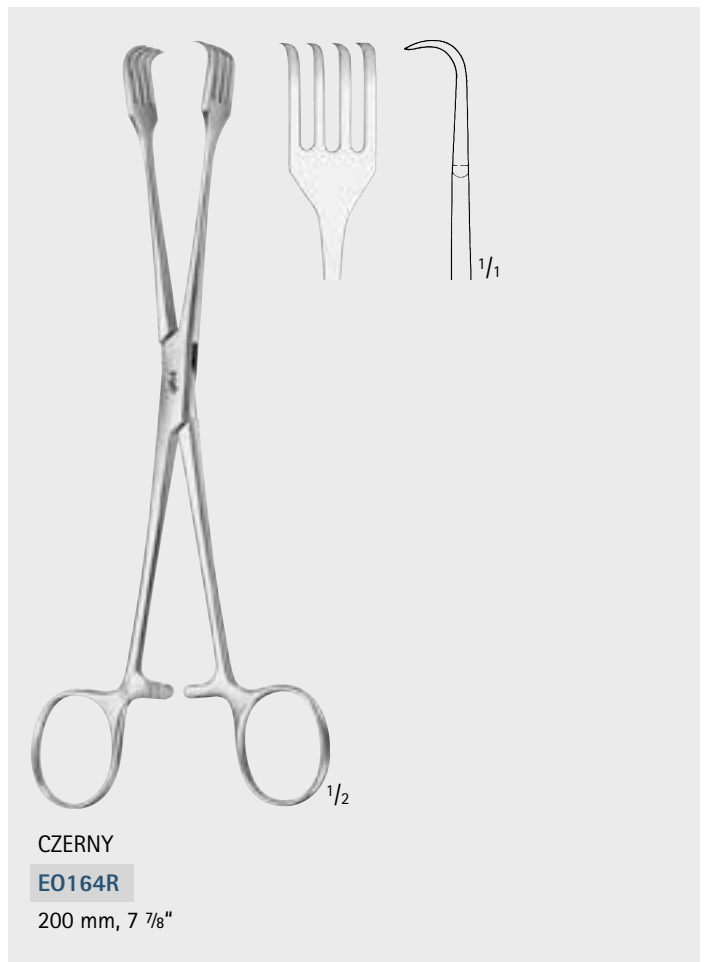
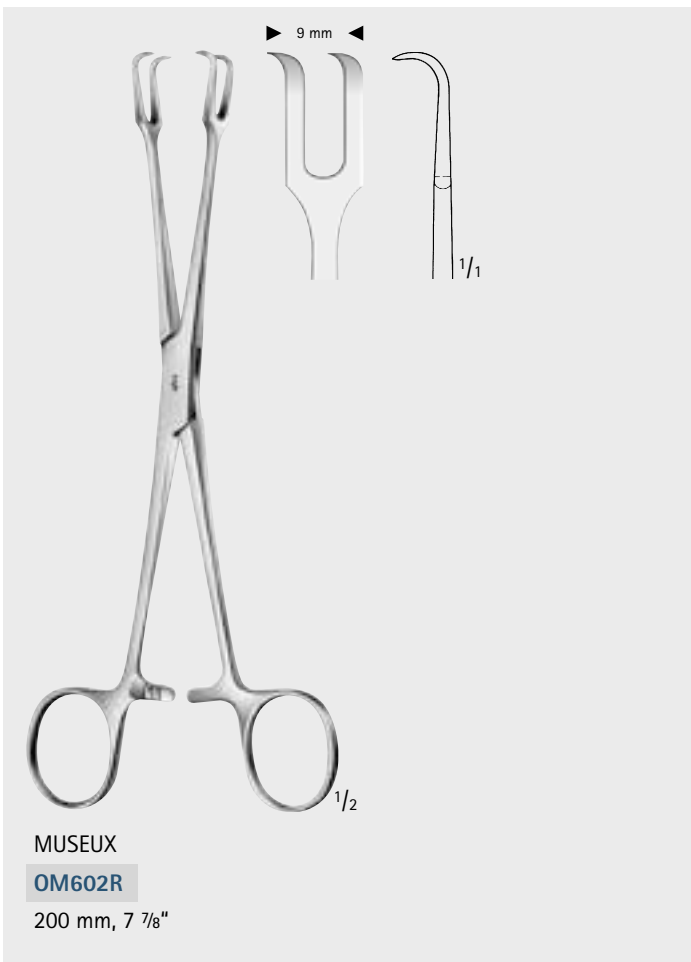
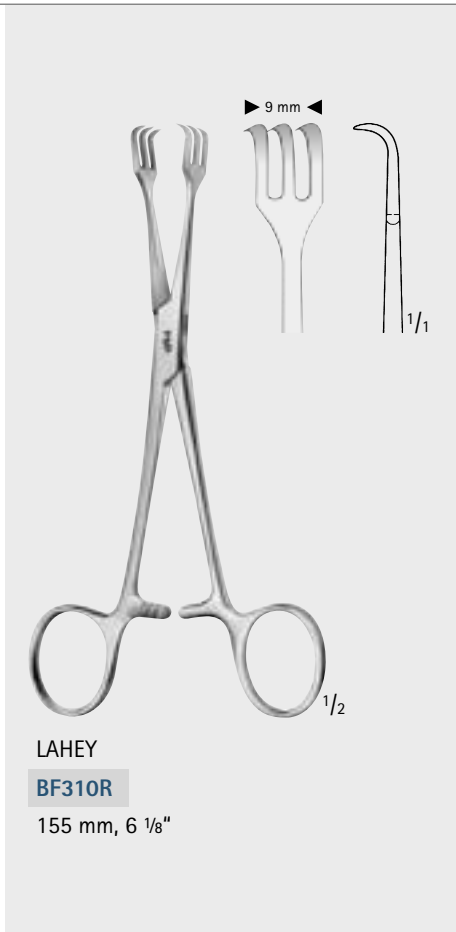
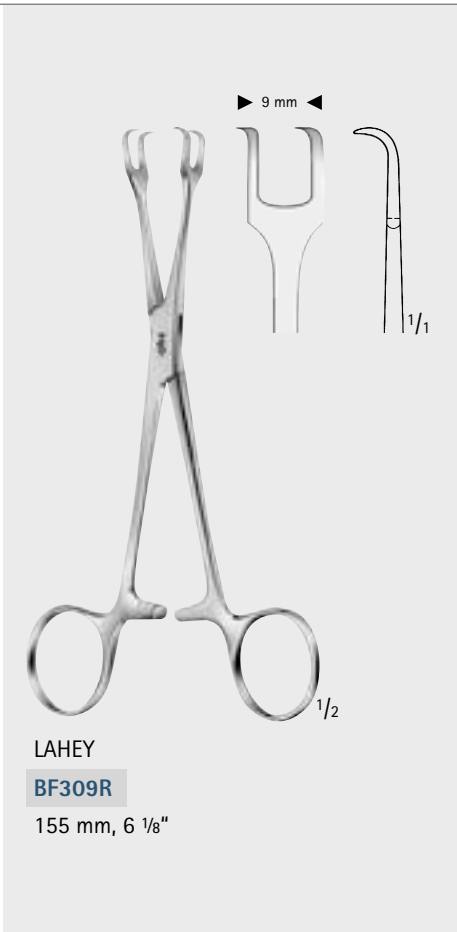

# Adenoidectomy, Tonsillectomy – Adenotomie, Tonsillektomie

## Tonsil Grasping Forceps

### Tonsillenfasszangen



Adenotomy  
Adenotomie

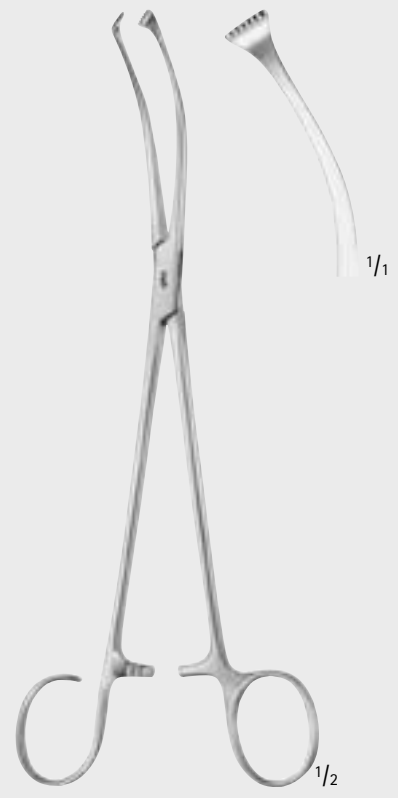

**COLVER**  
**OM611R**  
200 mm, 7 7/8"

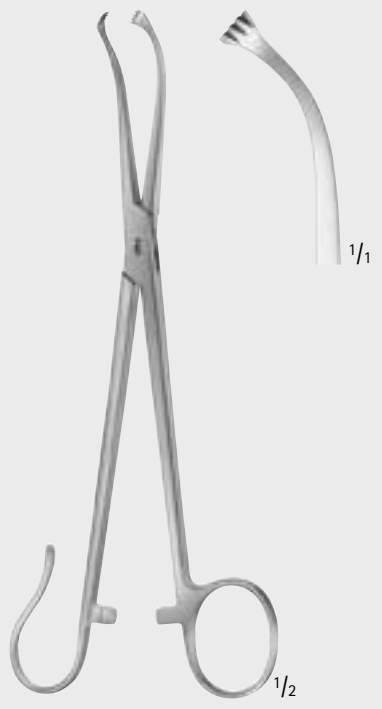

**WHITE**  
**OM612R**  
180 mm, 7"



**WHITE**  
**OM613R**  
235 mm, 9 1/4"

# Adenoidectomy, Tonsillectomy – Adenotomie, Tonsillektomie

## Tonsil Grasping Forceps

### Tonsillenfasszangen

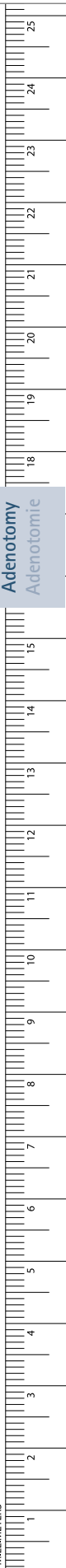
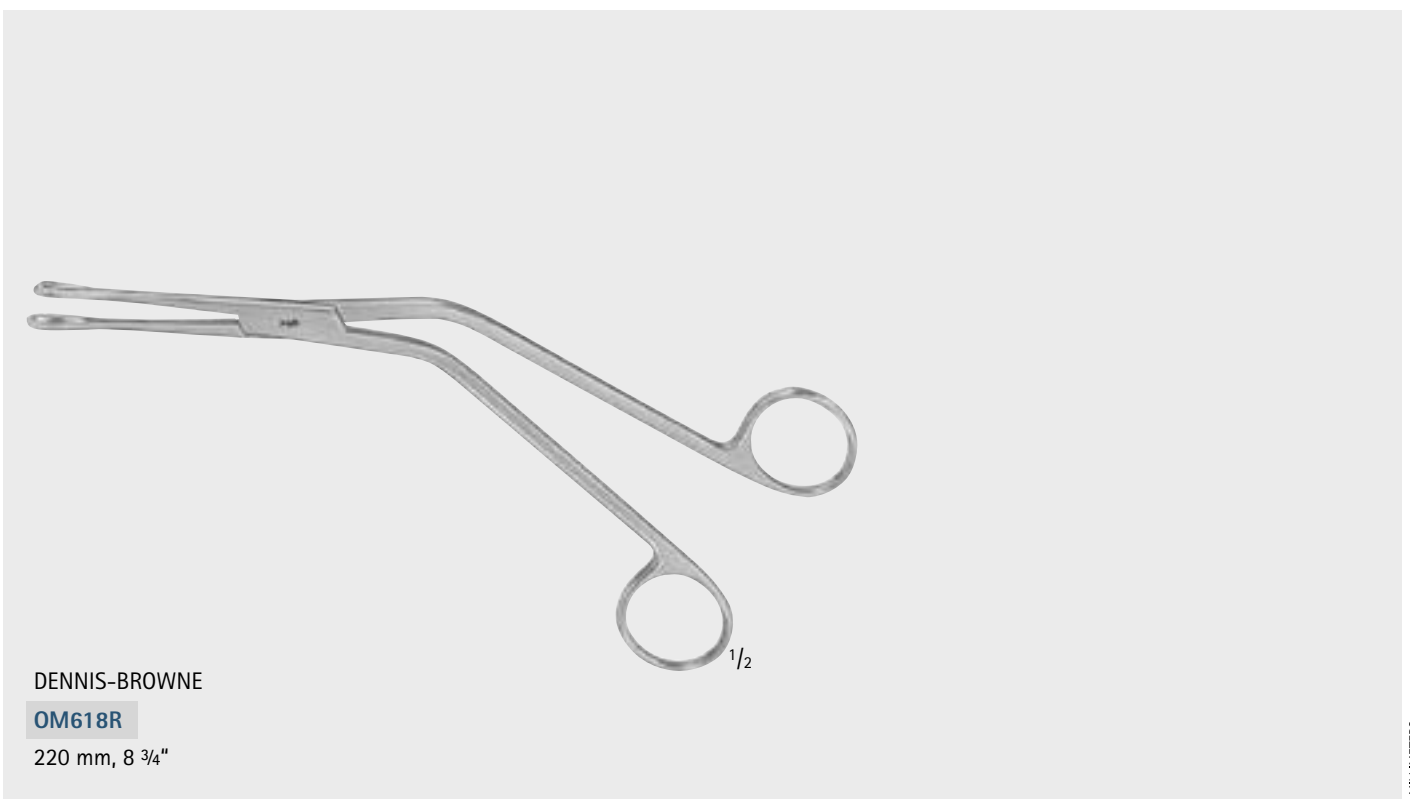
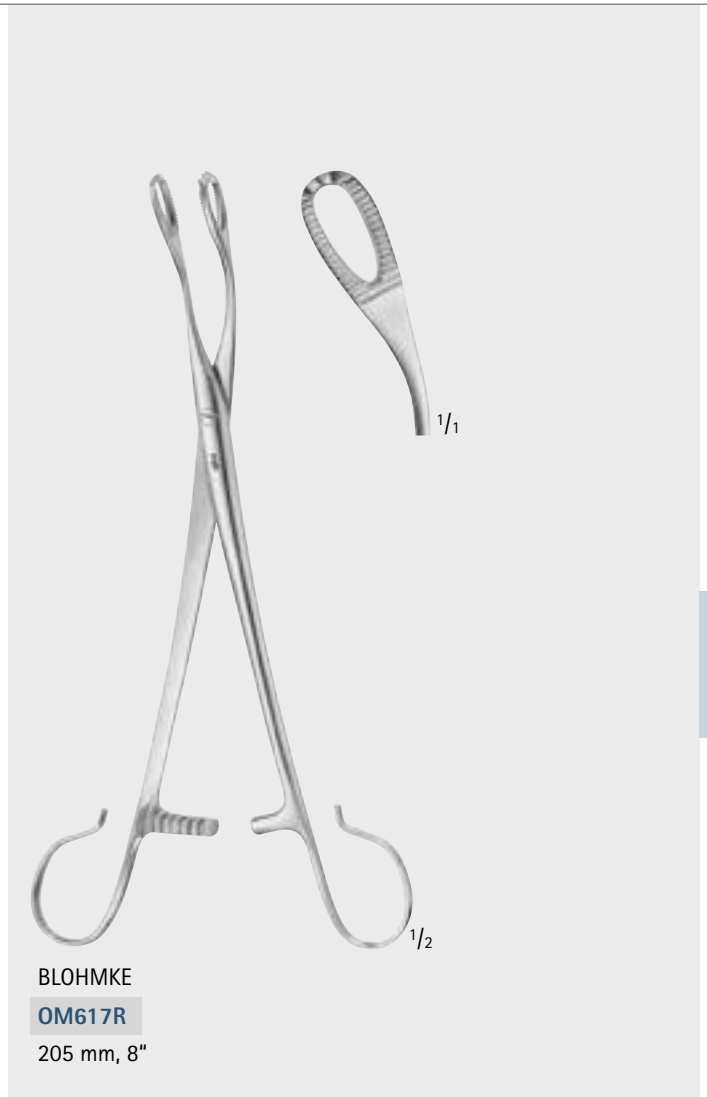
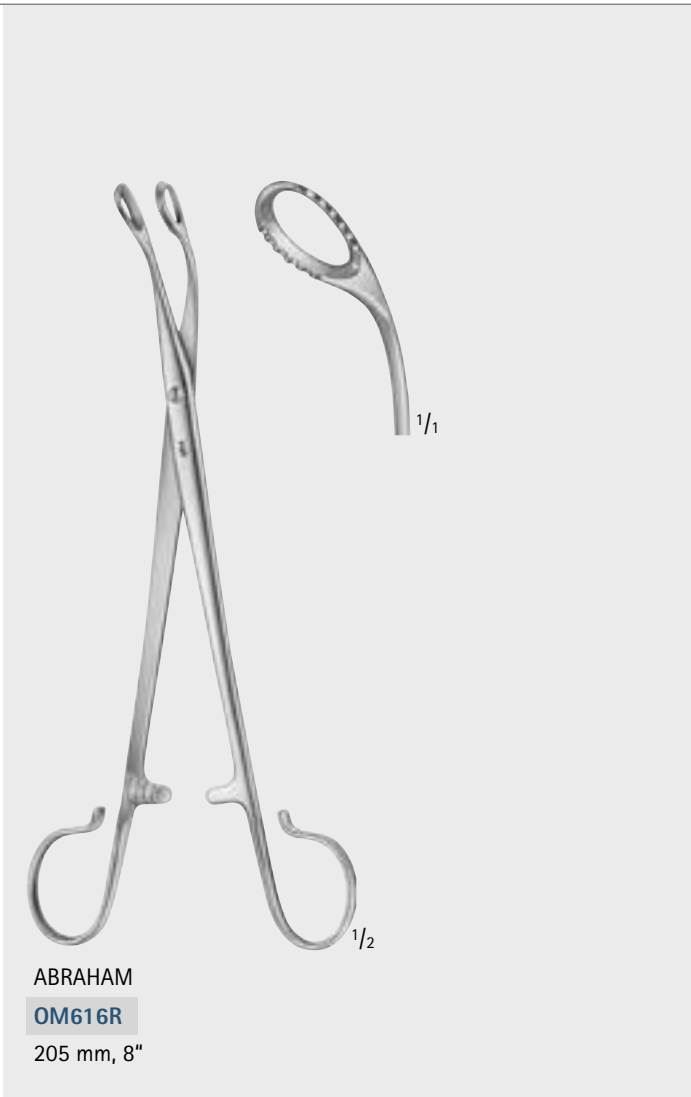

# Adenoidectomy, Tonsillectomy – Adenotomie, Tonsillektomie

## Tonsil Dissectors and Pillar Retractors

### Tonsillendissektoren und -retraktoren



Adenotomy  
Adenotomie



6 mm

1/1

1/2

1/1

HURD

**OM660R**

215 mm, 8 1/2"

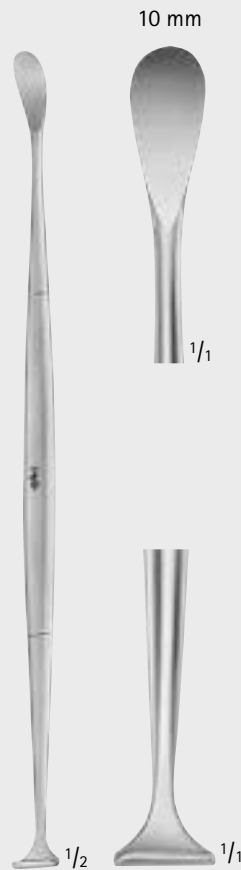

10 mm

1/1

1/2

1/1

HURD

**OM661R**

215 mm, 8 1/2"

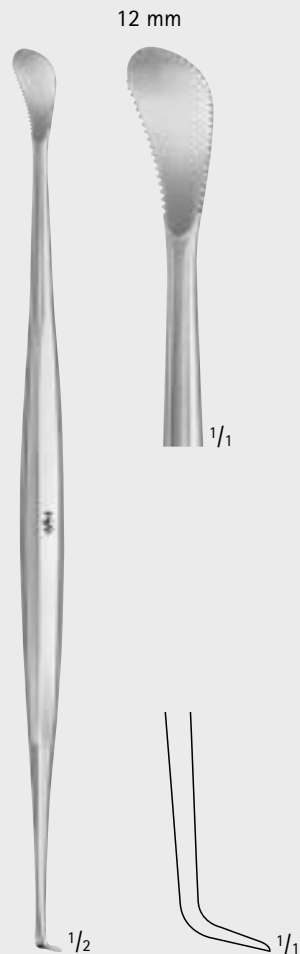

12 mm

1/1

1/2

1/1

HENKE

**OM668R**

235 mm, 9 1/4"

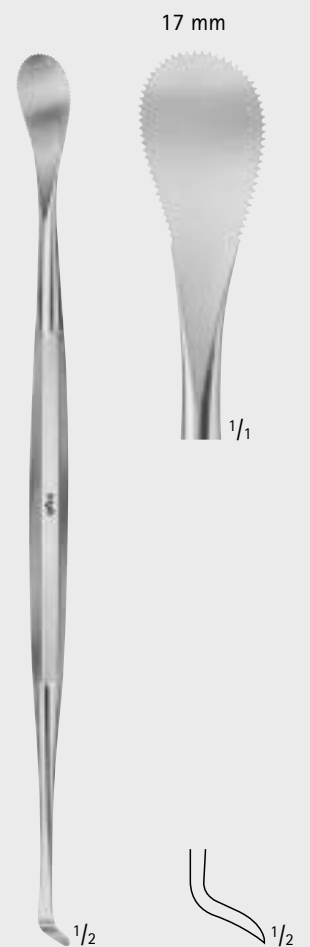

17 mm

1/1

1/2

1/2

HENKE

**OM669R**

235 mm, 9 1/4"



# Adenoidectomy, Tonsillectomy – Adenotomie, Tonsillektomie

## Tonsil Dissectors and Pillar Retractors

## Tonsillendissektoren und -retraktoren



GWYNNE-EVANS

**OM663R-OM664R**

Tonsil dissector, double ended  
Tonsillendissektor, doppelendig  
200 mm, 7 7/8"



SYME

**OM665R**

Tonsil dissector,  
blunt and sharp  
Tonsillendissektor,  
stumpf und scharf  
185 mm, 7 1/4"



MOLLINSON

**OM666R**

Tonsil dissector and pillar retractor,  
semi-sharp  
Tonsillendissektor und -retraktor,  
halb-scharf  
185 mm, 7 1/4"

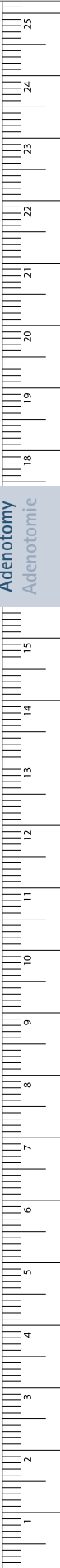

- Please find suction cannulas in chapter suction instruments, starting on page 525
- Saugkanülen, siehe Kapitel Sauger, ab Seite 525

# Adenoidectomy, Tonsillectomy – Adenotomie, Tonsillektomie

Sickle Knife, Tonsil Knife, Tonsil Retractor

Sichelmesser, Tonsillmesser, Tonsillenretraktor



Adenotomy  
Adenotomie



**OF601R**

Sickle knife, sharp tip  
Sichelmesser, spitz  
190 mm, 7 1/2"



**FOWLER**

**OM680R**

Tonsil knife  
Tonsillmesser  
200 mm, 7 7/8"



**ABRAHAM**

**OM681R**

Tonsil knife  
Tonsillmesser  
220 mm, 8 3/4"



**FISHER**

**OM688R**

Tonsil knife  
Tonsillmesser  
205 mm, 8"



**NAGER**

**OM637R**

Tonsil retractor  
Tonsillenretraktor  
230 mm, 9"

# Adenoidectomy, Tonsillectomy – Adenotomie, Tonsillektomie

## Tonsil Scissors Tonsillenscheren

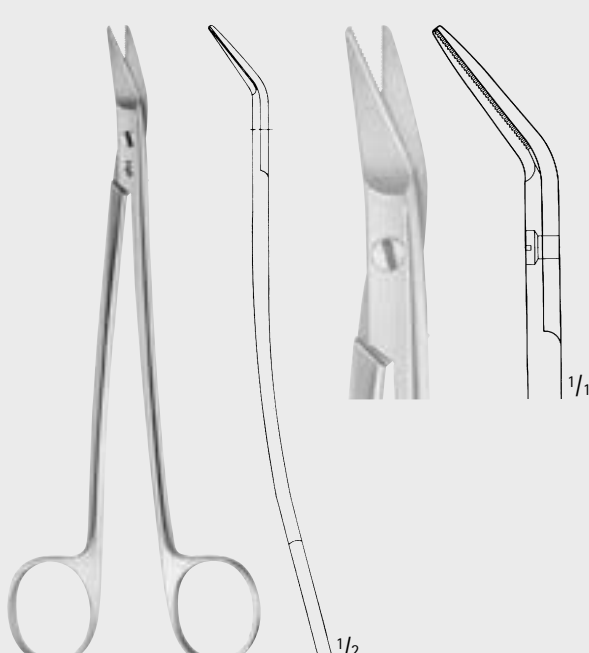

DEAN  
**OM700R**  
with angled serrated blades  
aufgebogen, Schneiden fein  
gezahnt  
170 mm, 6 3/4"



BOETTCHER  
**OM707R**  
180 mm, 7"

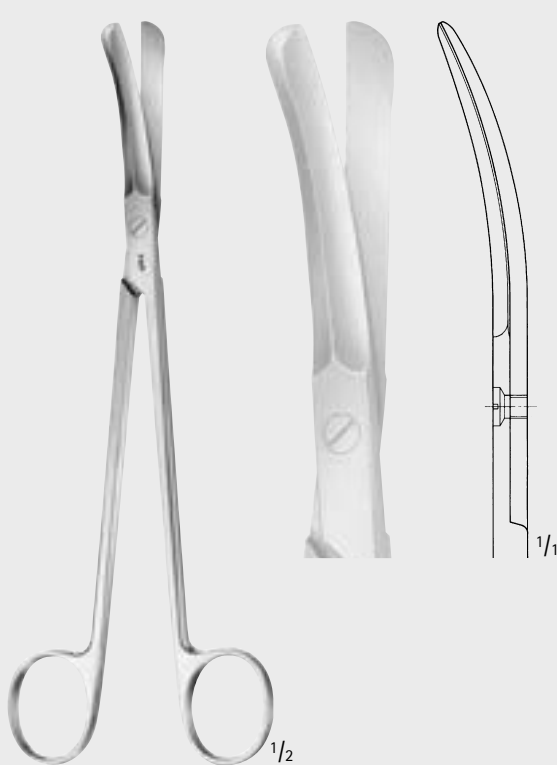

GOOD  
**OM710R**  
195 mm, 7 3/4"

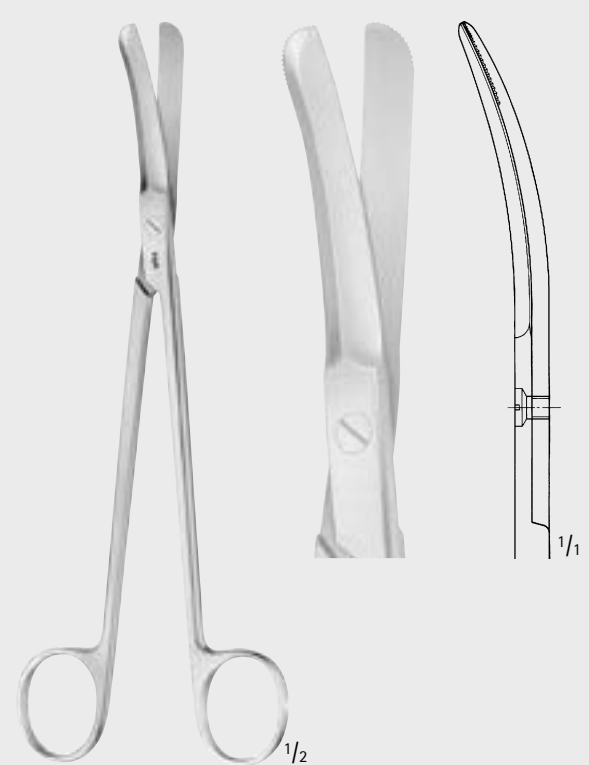

SCHWECKENDIEK  
**OM711R**  
195 mm, 7 3/4"

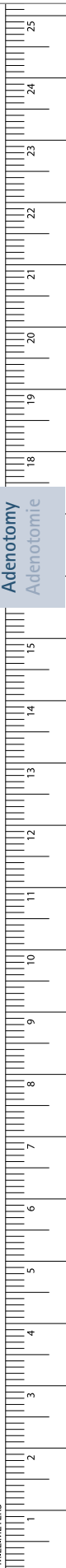

# Adenoidectomy, Tonsillectomy – Adenotomie, Tonsillektomie

Tonsil Snare, Single Use Tonsil Snare

Tonsillenschnürer, Einmal Tonsillenschnürer



Adenotomy  
Adenotomie



**EVES**  
**OM760R**  
Tonsil snare complete with wire (25 swg)  
Tonsillenschnürer, komplett mit Drahtschlinge  
250 mm, 9 3/4"



**EVES**  
**OM761R**  
Tonsil snare with ratchet, complete with wire (25 swg)  
Tonsillenschnürer mit Sperre, komplett mit Drahtschlinge  
250 mm, 9 3/4"



**BRÜNNINGS**  
**OM768R**  
Tonsil snare  
Tonsillenschnürer  
270 mm, 10 5/8"



**EVES**  
**OM760SU**  
Single use tonsil snare, with two wire loops, sterile, pack with 20 pieces  
Einmal Tonsillenschnürer, mit 2 Drahtschlingen, steril, Pack mit 20 Stück  
285 mm, 11 1/4"

# Adenoidectomy, Tonsillectomy – Adenotomie, Tonsillektomie

Snare Wires, Wire Loops

Schnürerdrähte, Drahtschlingen

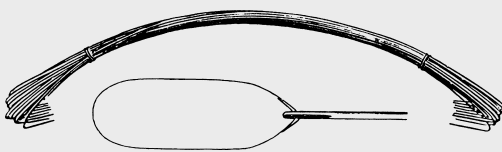

Art. No.	Diam. (mm)
Art. Nr.	Ø (mm)

**OM750R** 0.3

**OM751R** 0.5

Snare wires,

Sales unit: **PAK** = Package of 12 pieces

Schnürerdrähte,

Bestelleinheit: **PAK** = Packung à 12 Stück

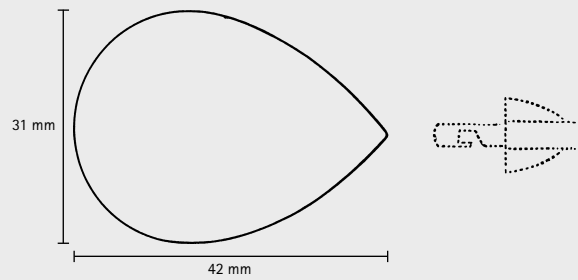

**OM757R**

Wire loops, diam 0.4 mm

Sales unit: **PAK** = Package of 100 pieces

Drahtschlingen, Ø 0,4 mm

Bestelleinheit: **PAK** = Packung à 100 Stück

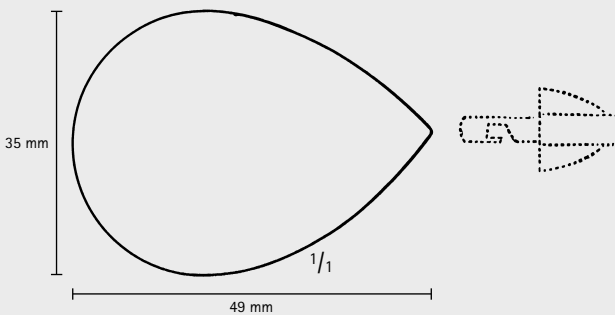

**OM758R**

Wire loops, diam. 0.4 mm

Sales unit: **PAK** = Package of 100 pieces

Drahtschlingen, Ø 0,4 mm

Bestelleinheit: **PAK** = Packung à 100 Stück

Adenotomie  
Adenotomie

MILLIMETERS

# Adenoidectomy, Tonsillectomy – Adenotomie, Tonsillektomie

## Tonsil Snare, Tip, Ligature Instrument, Knot Tyer

Tonsillenschnürer, Aufsatz, Ligaturinstrument, Fadengabel

Adenotomy  
Adenotomie

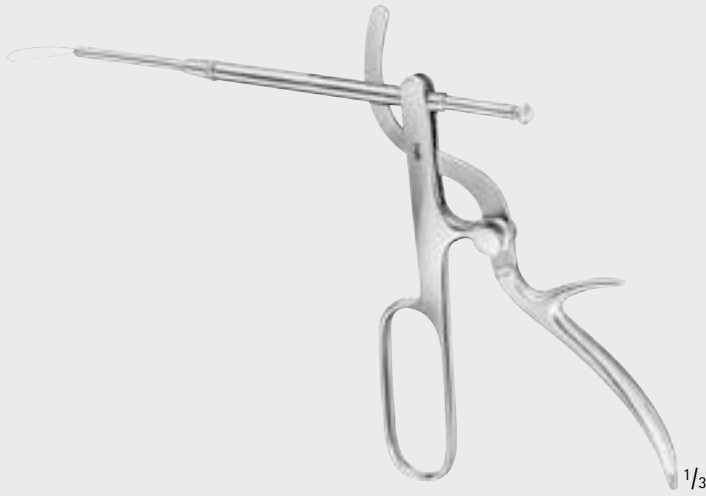

TYDING

**OM781R**

Tonsil snare with detachable tip OM776R to fit wires OM750R, OM751R

Tonsillenschnürer mit abnehmbarem, geradem Aufsatz OM776R  
Passend zu Schnürdrähten OM750R, OM751R



TYDING

**OM776R**

Tip only, straight  
gerader Aufsatz



ROEDER

**OM915R**

Ligature instrument, form E  
Ligaturinstrument, Form E  
260 mm, 10 1/4"



NEGUS

**OM917R**

Knot tyer  
Fadengabel  
205 mm, 8"

# Adenoidectomy, Tonsillectomy – Adenotomie, Tonsillektomie

Blades for Tonsillotome Handle, Tonsillotome Handle, Tonsil Punches

Aufsätze für Tonsillotomgriff, Tonsillotomgriff, Tonsillenstanze

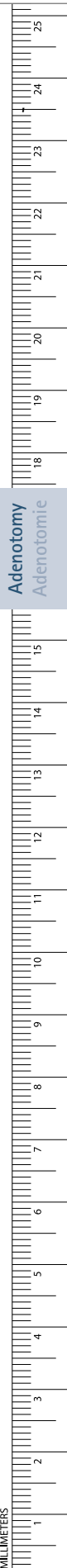
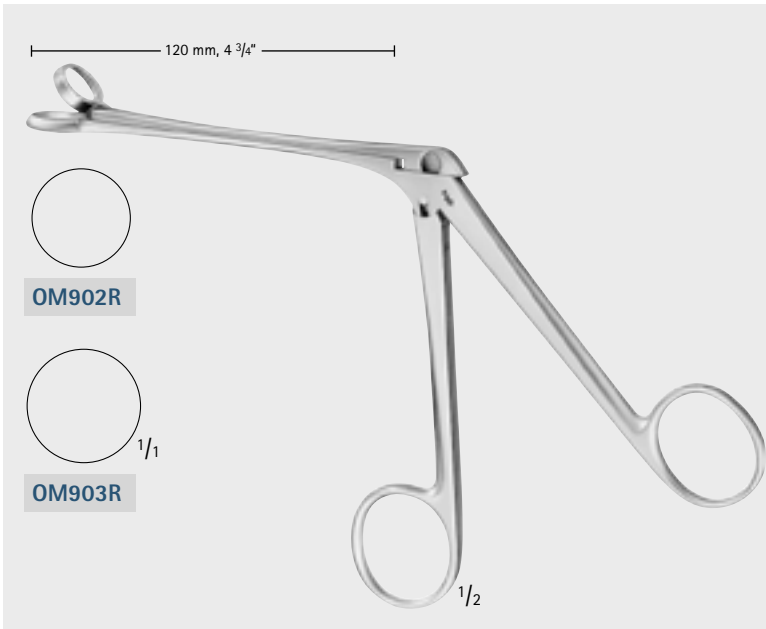
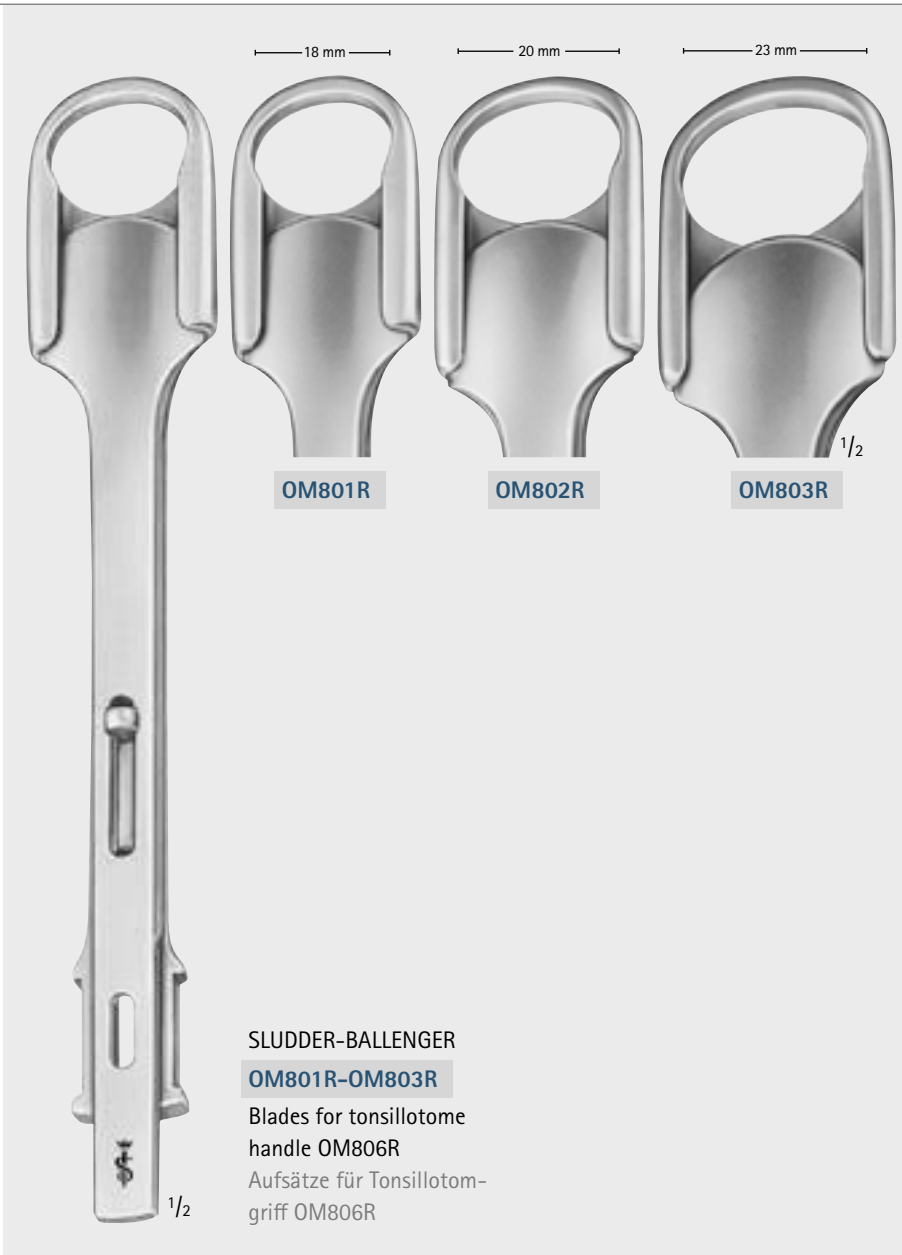

# Adenoidectomy, Tonsillectomy - Adenotomie, Tonsillektomie

## Adenoid Currettes

### Ringmesser



Adenotomy  
Adenotomie



1/2

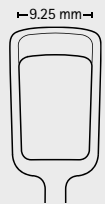

OM451R

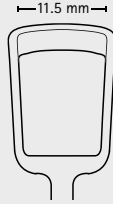

OM452R

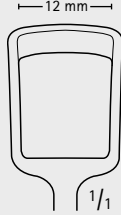

OM453R

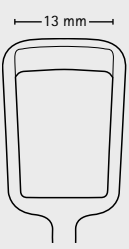

OM454R

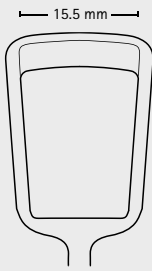

OM455R

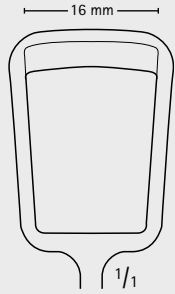

OM456R

BECKMANN

OM451R-OM456R

200 mm, 7 7/8"



1/2



OM500R



OM501R



OM502R



OM503R



OM504R



OM505R

BECKMANN

OM500R-OM505R

220 mm, 8 3/4"



# Adenoidectomy, Tonsillectomy – Adenotomie, Tonsillektomie

## Adenoid Curettes

### Ringmesser

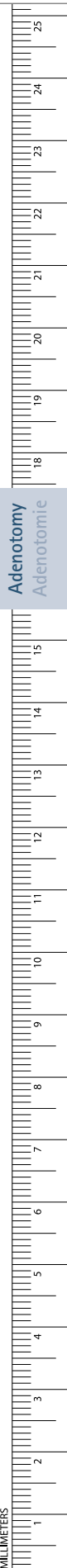
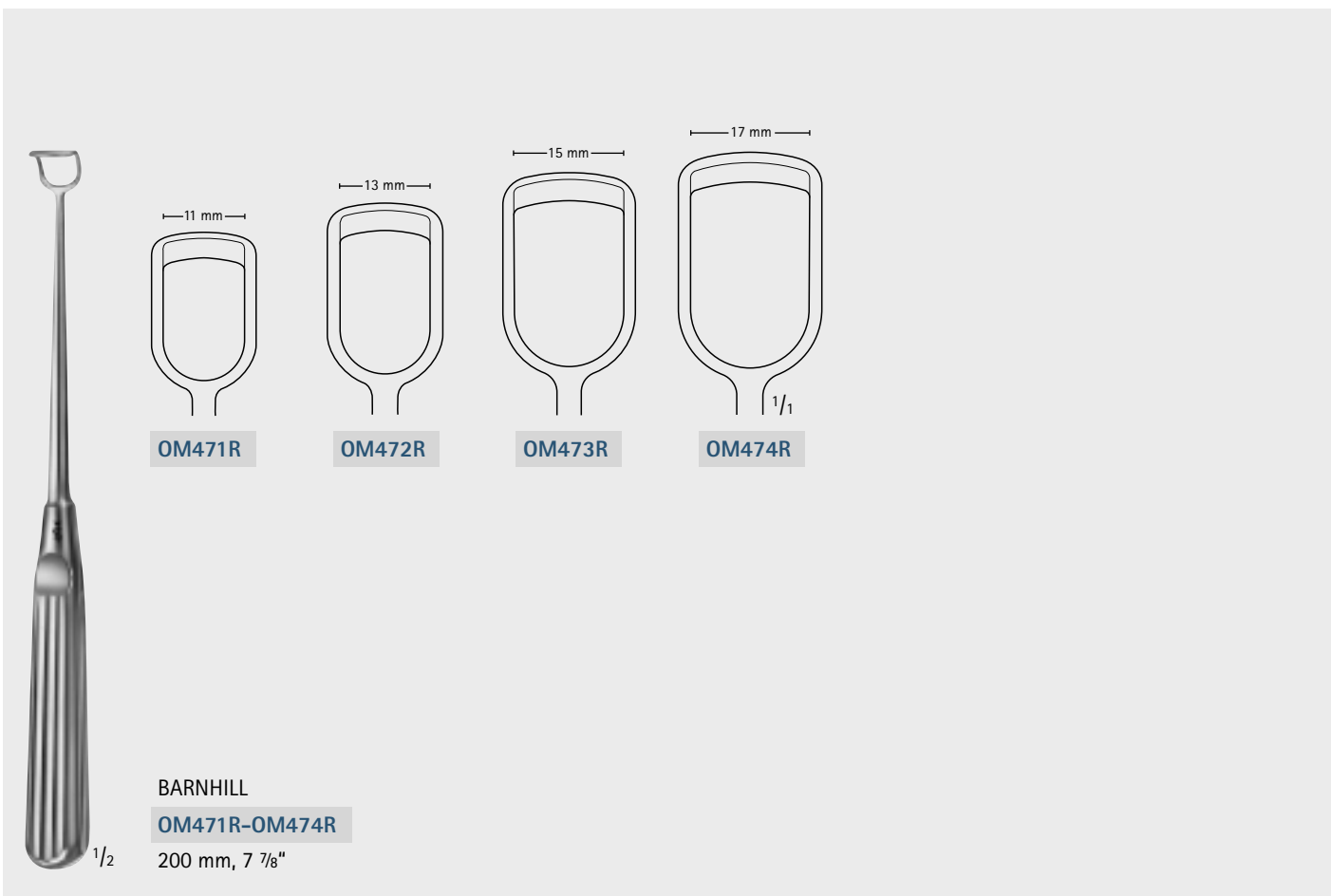
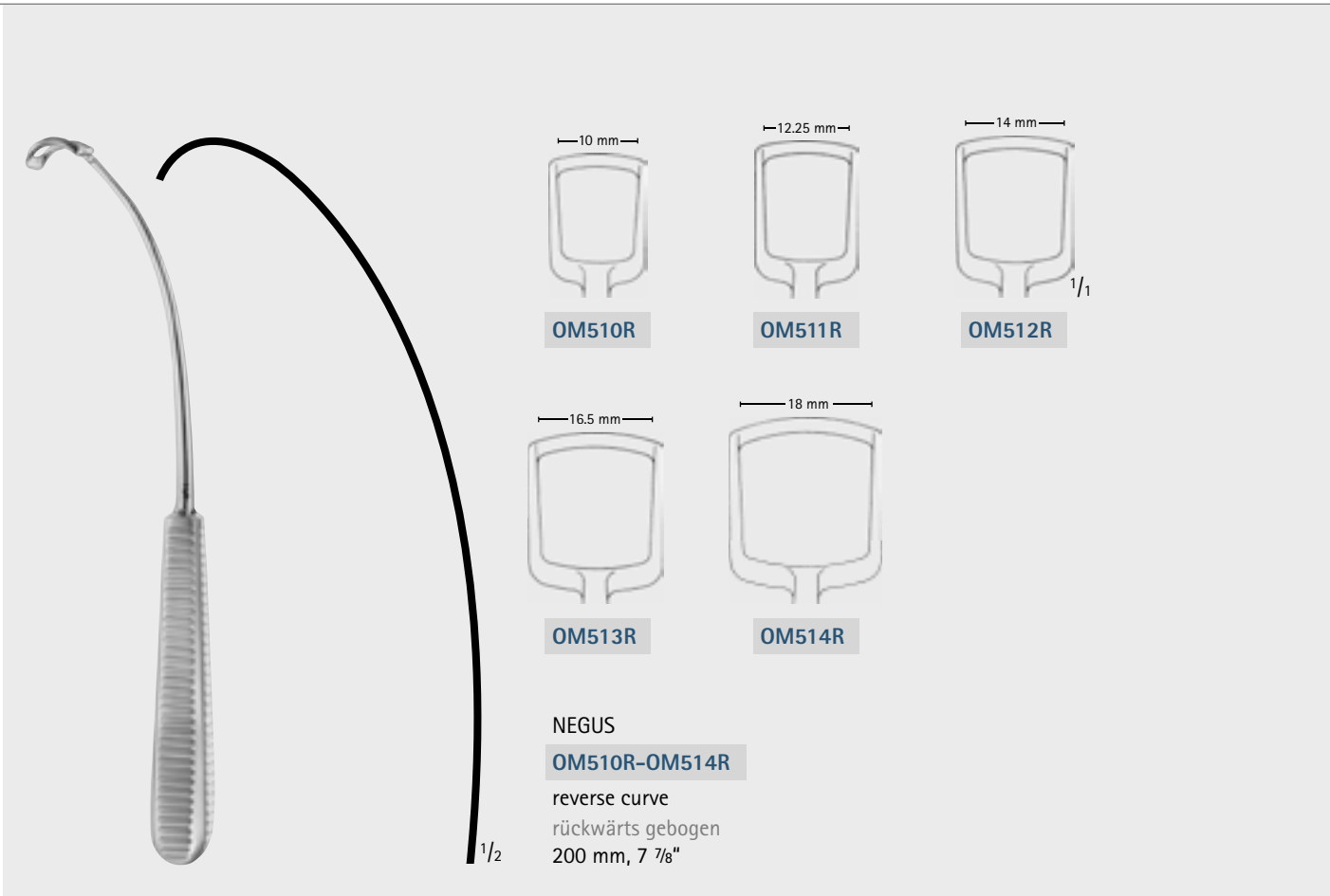

Adenotomie  
Adenotomie

# Adenoidectomy, Tonsillectomy – Adenotomie, Tonsillektomie

## Adenoid Currettes

### Ringmesser

Adenotomy  
Adenotomie

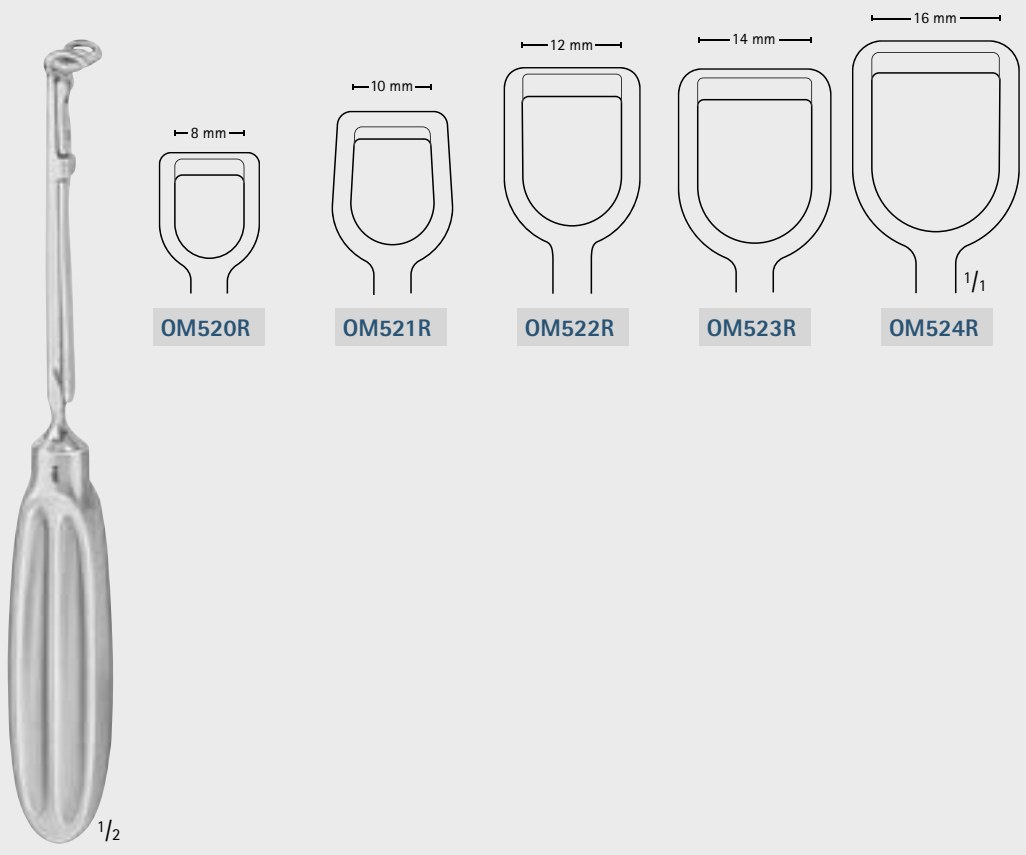

ST. CLAIR-THOMPSON

**OM520R-OM524R**

with cage

mit Fangkorb

210 mm, 8 1/4"

# Adenoidectomy, Tonsillectomy – Adenotomie, Tonsillektomie

## Adenotomes, Spare Blades

### Pharynx Tonsillotom, Ersatzklingen



**OM391R**

1/2



**OM392R**

1/2



**OM393R**

1/2

LA FORCE

**OM391R-OM393R**

Adenotomes

Pharynx tonsillotom

235 mm, 9 1/4"

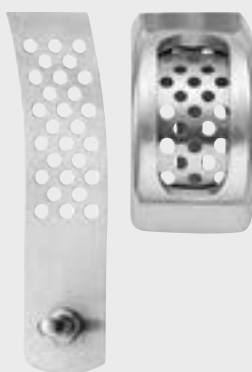

**OM396R**



**OM397R**

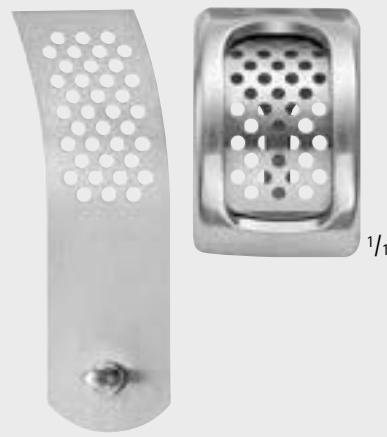

**OM398R**

1/1

LA FORCE

**OM396R-OM398R**

Spare blades only, perforated  
suitable for OM391R-OM393R

Ersatzklingen, allein, gelocht,  
passend für OM391R-OM393R

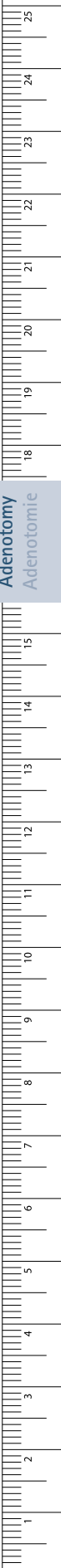

MILLIMETERS

# Adenoidectomy, Tonsillectomy – Adenotomie, Tonsillektomie

Nasopharynx Forceps, Adenoid Cutting Forceps

Nasenrachenzangen



Adenotomy  
Adenotomie

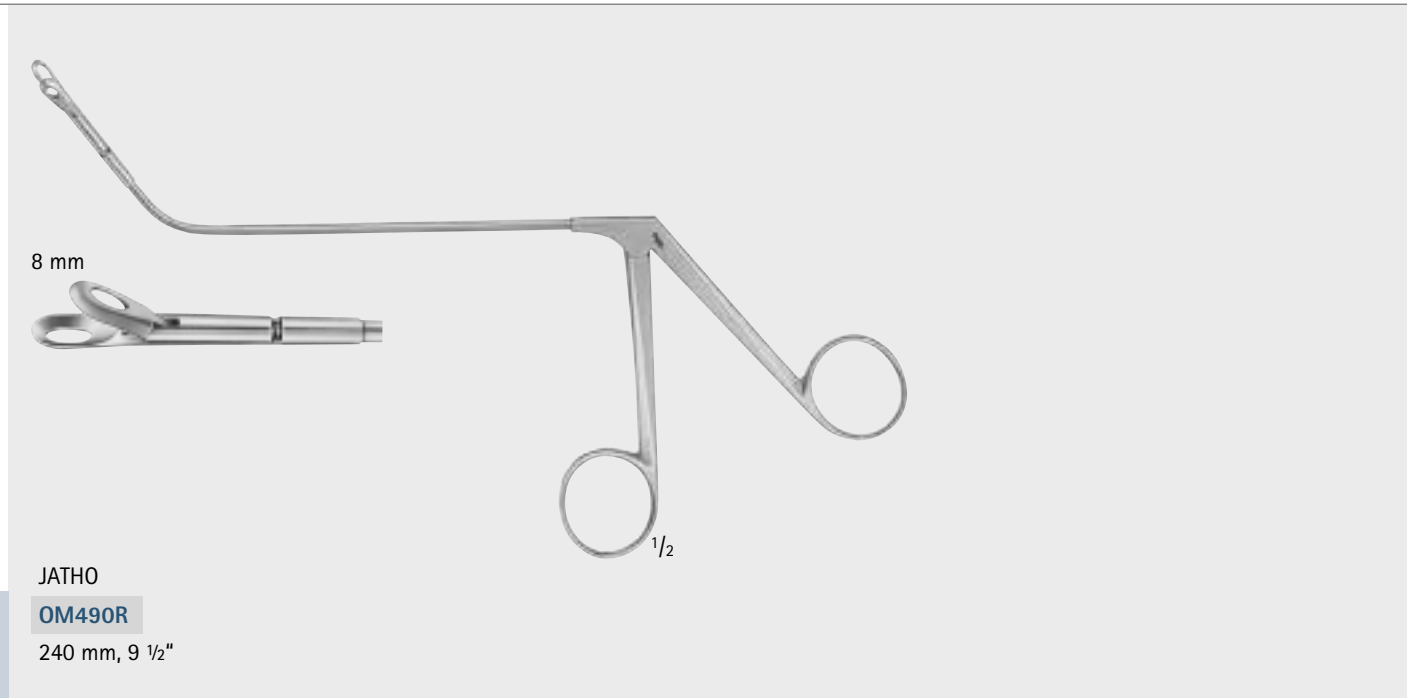

JATHO  
**OM490R**  
240 mm, 9 1/2"



JURASZ  
**OM496R**  
for children  
für Kinder  
190 mm, 7 1/2"

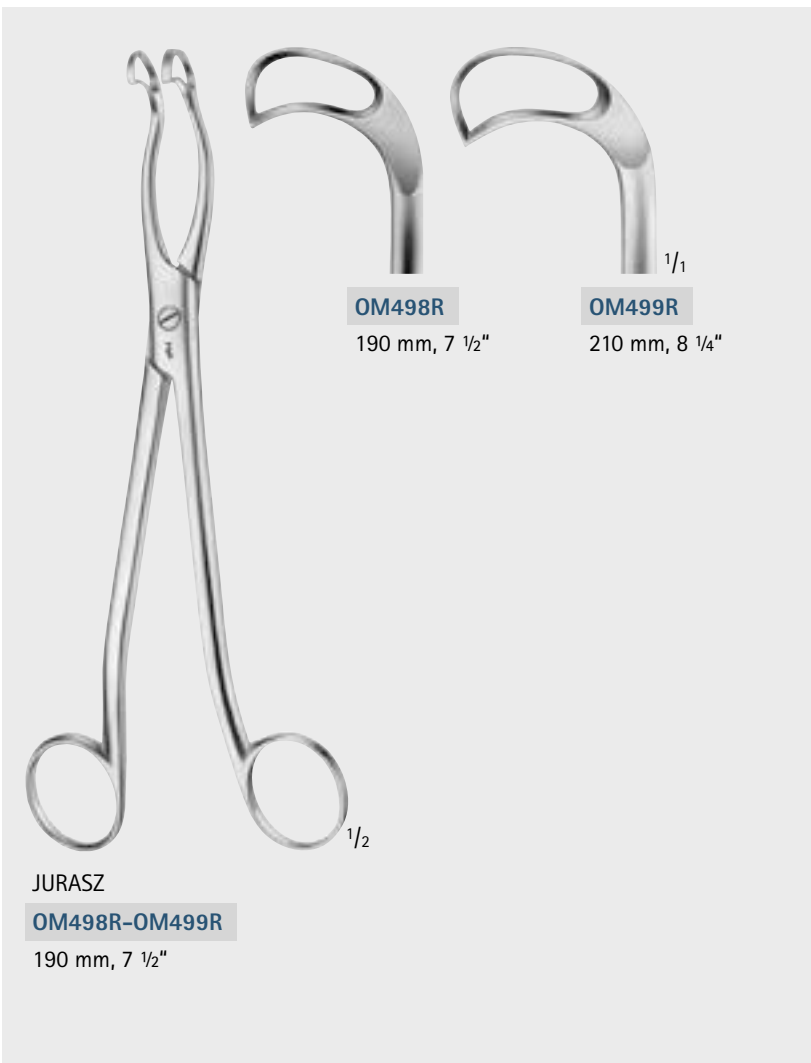

JURASZ  
**OM498R-OM499R**  
190 mm, 7 1/2"

**OM498R**  
190 mm, 7 1/2"

**OM499R**  
210 mm, 8 1/4"

- Please find further forceps and conchotomes in chapter Rhinology, FESS, Rhinoplasty, starting on page 70
- Weitere Zangen und Conchotome siehe Kapitel Rhinologie, FESS und Septum- und Nasenplastik, ab Seite 70

Laryngology  
Laryngologie







# Laryngology - Laryngologie

## Laryngeal Mirrors and Handles

### Kehlkopfspiegel und -Griffe

- OM078R-OM090R: with handle / mit Griff
- AC468R-AC480R: without handle / ohne Griff

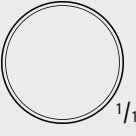
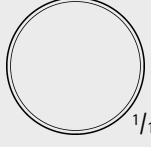
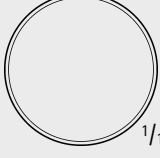
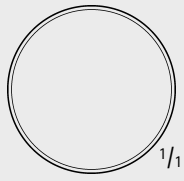
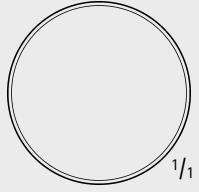
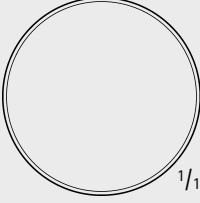
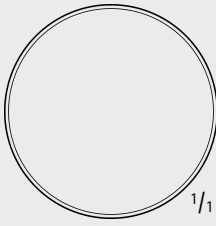
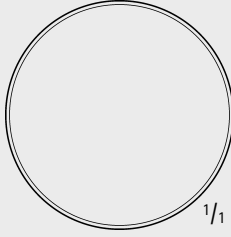
 <b>OM078R/ AC468R</b> Fig. 000 Diam. 6 mm Ø 6 mm	 <b>OM079R/ AC469R</b> Fig. 00 Diam. 8 mm Ø 8 mm	 <b>OM080R/ AC470R</b> Fig. 0 Diam. 10 mm Ø 10 mm	 <b>OM081R/ AC471R</b> Fig. 1 Diam. 12 mm Ø 12 mm	 <b>OM082R/ AC472R</b> Fig. 2 Diam. 14 mm Ø 14 mm	 <b>OM083R/ AC473R</b> Fig. 3 Diam. 16 mm Ø 16 mm	 <b>OM084R/ AC474R</b> Fig. 4 Diam. 18 mm Ø 18 mm	 <b>OM085R/ AC475R</b> Fig. 5 Diam. 20 mm Ø 20 mm
 <b>OM086R/ AC476R</b> Fig. 6 Diam. 22 mm Ø 22 mm	 <b>OM087R/ AC477R</b> Fig. 7 Diam. 24 mm Ø 24 mm	 <b>OM088R/ AC478R</b> Fig. 8 Diam. 26 mm Ø 26 mm	 <b>OM089R/ AC479R</b> Fig. 9 Diam. 28 mm Ø 28 mm	 <b>OM090R/ AC480R</b> Fig. 10 Diam. 30 mm Ø 30 mm			



**OM078R-OM090R**  
Laryngeal mirrors  
with hexagonal handle  
Kehlkopfspiegel  
mit Sechskantgriff  
180 mm, 7"



**AC468R-AC480R**  
Laryngeal mirrors  
Kehlkopfspiegel  
120 mm, 4 3/4"



**AC481R**  
Mirror handle  
Spiegelgriff  
110 mm, 4 1/4"



**AC483C**  
Mirror handle  
Spiegelgriff  
105 mm, 4 1/8"

## Laryngology - Laryngologie

### Operation Laryngoscopes, Chest Support and Laryngoscope Holder

### Operations-Laryngoskope, Bruststütze und Laryngoskophalter



**OP280R, OP292R-OP295R**

Operating laryngoscopes  
Operations-Laryngoskope



**OP281R-OP282R**

Operating laryngoscopes  
Operations-Laryngoskope

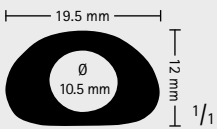

**OP280R**

for children, small size  
für Kinder, klein  
130 mm, 5 1/8"

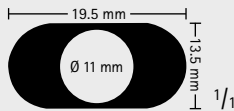

**OP295R**

for children  
für Kinder  
130 mm, 5 1/8"

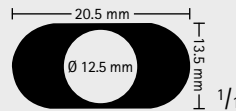

**OP294R**

for adolescents, small size  
für Jugendliche, klein  
180 mm, 7"

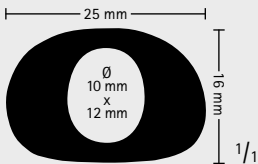

**OP281R**

for adults, medium size  
für Erwachsene, mittel  
180 mm, 7"

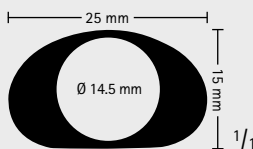

**OP293R**

for adults, medium size  
für Erwachsene, mittel  
180 mm, 7"

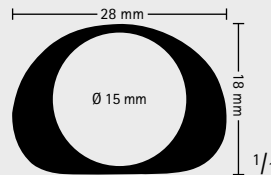

**OP292R**

for adults, large size  
für Erwachsene, groß  
180 mm, 7"

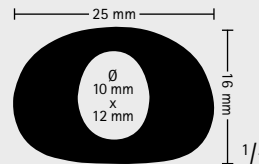

**OP282R**

for adults, medium size for long neck  
für Erwachsene, mittel für langen Hals  
220 mm, 8 3/4"



**OP290R**

Chest support and laryngoscope holder,  
for adults and children  
Bruststütze und Laryngoskophalter,  
für Erwachsene und Kinder

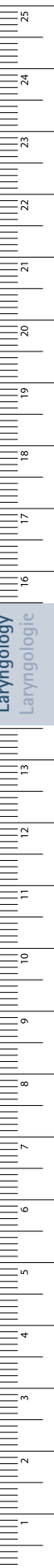

Laryngologie  
Laryngologie

MILLIMETERS

## Laryngology – Laryngologie

### Light Guides, Teeth Protector

### Lichtleiter, Zahnschutz



#### OP297R

Light guide for use with laryngoscopes OP281R–OP294R and Aesculap light guide cables.

Suitable Aesculap light guide cable OP913, 2.5 m long.

Lichtleiter für Laryngoskop OP281R–OP294R und Anschluss an Aesculap Lichtleitkabel.

Passendes Aesculap Lichtleitkabel OP913, 2,5 m lang.

- For further light guide cables and light sources see Aesculap brochure C46702.
- Weitere Lichtleitkabel und Lichtquellen finden Sie im Aesculap Prospekt C46701.

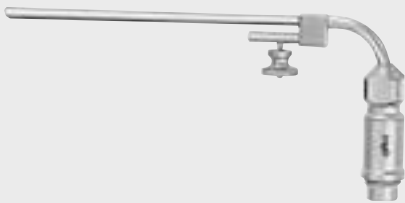

#### OP298R

Light guide for use with laryngoscope OP280R, OP295R and Aesculap light guide cables.

Lichtleiter für Laryngoskop OP280R, OP295R und Anschluss an Aesculap Lichtleitkabel.



#### OP299

Teeth protector, made of silicone

Zahnschutz aus Silikon



# Laryngology - Laryngologie

## Micro Laryngeal Grasping Forceps

### Mikro-Laryngoskopie Fasszängchen

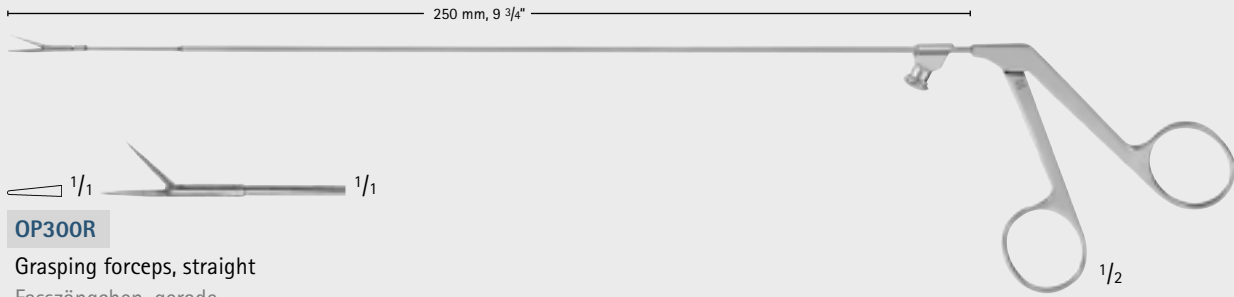

**OP300R**

Grasping forceps, straight  
Fasszängchen, gerade



**OP301R**

Grasping forceps, left curved  
Fasszängchen, links gebogen



**OP302R**

Grasping forceps, right curved  
Fasszängchen, rechts gebogen

**OP300R-OP302R**

Tubular shaft forceps  
for endolaryngeal microsurgery  
Rohrschaftzängchen  
für die endolaryngoskopische  
Mikro-Chirurgie

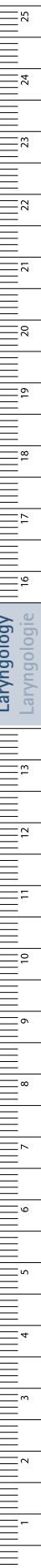

Laryngology  
Laryngologie

# Laryngology - Laryngologie

## Micro Laryngeal Cup Forceps, Micro Laryngeal Scissors

### Mikro-Laryngoskopie-Löffelzängchen, Mikro-Laryngoskopie-Scherchen

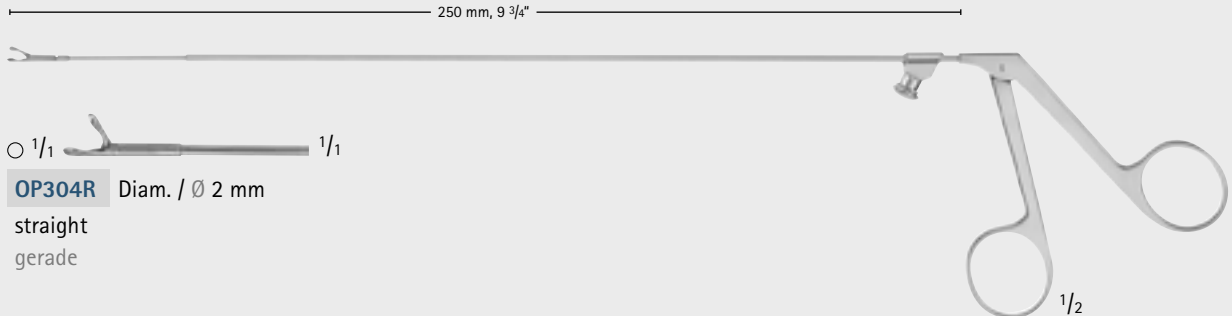
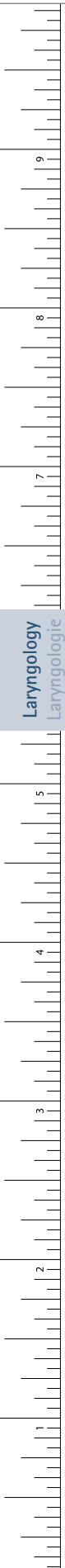

○ 1/1 1/1

**OP304R** Diam. / Ø 2 mm  
straight  
gerade

○ 1/1 1/1

**OP305R** Diam. / Ø 2 mm  
left curved  
links gebogen

○ 1/1 1/1

**OP306R** Diam. / Ø 2 mm  
right curved  
rechts gebogen

○ 1/1 1/1

**OP307R** Diam. / Ø 2 mm  
upwards angled  
aufgebogen

**OP304R-OP307R**  
Cup forceps  
Löffelzängchen

Laryngology  
Laryngologie

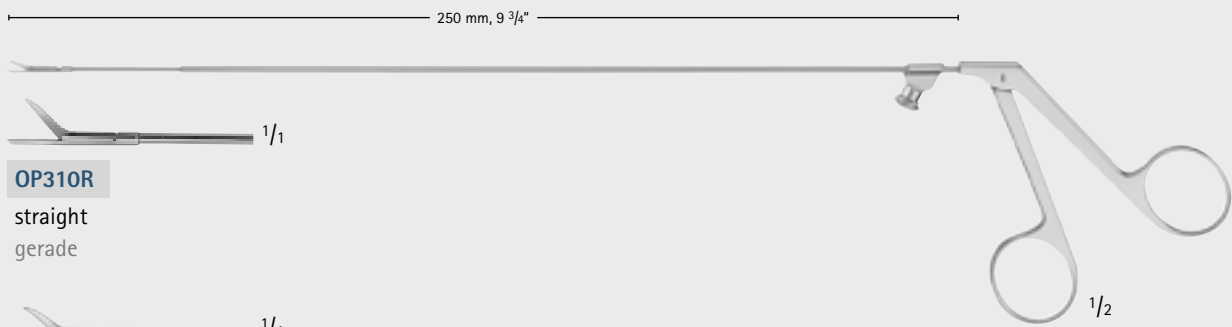

1/1

**OP310R**  
straight  
gerade

1/1

**OP311R**  
left curved  
links gebogen

1/1

**OP312R**  
right curved  
rechts gebogen

1/1

**OP313R**  
upwards angled  
aufgebogen

**OP310R-OP313R**  
Scissors  
Scherchen

## Laryngology - Laryngologie

### Micro Laryngeal Forceps, Laryngeal Needle Holder Mikro-Laryngoskopie-Zängchen, Kehlkopfnadelhalter

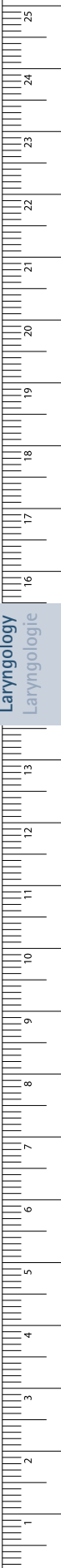
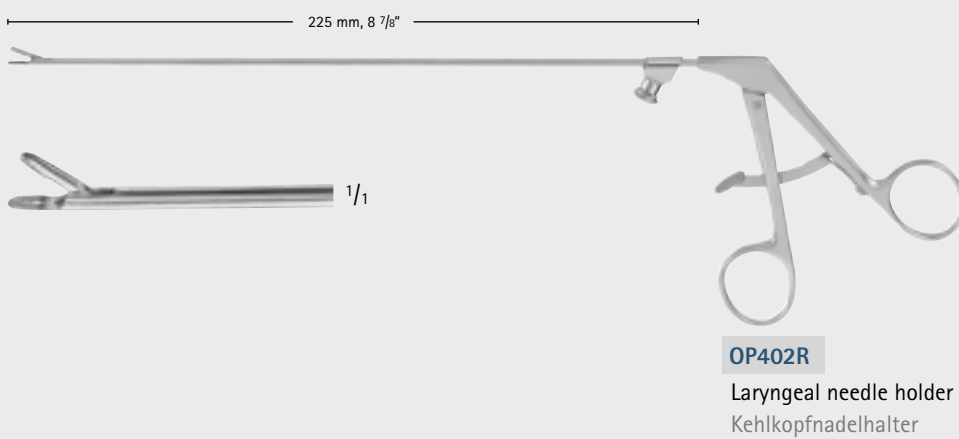
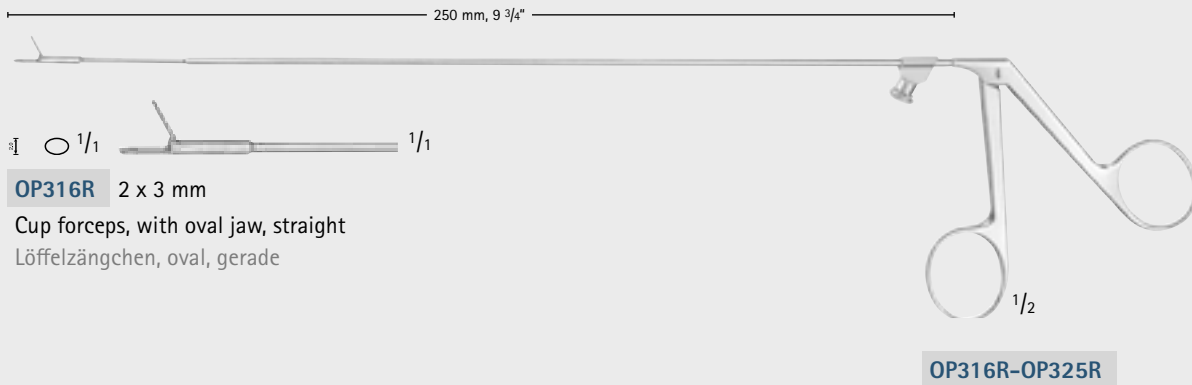

# Laryngology - Laryngologie

## Micro Laryngeal Instruments

## Mikro-Laryngoskopie Instrumente



**OP386R**  
Sickle knife  
Sichelmesser



**OP403R**  
Knife,  
straight cut  
Messers,  
gerader Schnitt



**OP387R**  
Separator,  
oval blade, horizontal  
Schäl-Messer,  
quer, oval



**OP388R**  
Separator,  
oval blade, vertical  
Schäl-Messer,  
längs, oval



**OP405R**  
Separator,  
oval, curved  
Schäl-Messer,  
oval, gebogen



**OP389R** Diam. / Ø 3.5 mm  
Round cutting knife,  
45° angled  
Schäl-Messer,  
45° abgewinkelt



**OP390R**  
Hook,  
90° angled, blunt  
Häkchen,  
90° gebogen, stumpf



**OP406R**  
Hook, sharp  
Häkchen, scharf



**OP392R**  
Hook,  
backwards curved  
Häkchen,  
retrograd gebogen



**OP409R**  
Hook,  
90° angled, blunt  
Häkchen,  
90° gewinkelt, stumpf



**OP396R**  
Suture guide,  
fork-shaped  
Fadengabel



**OP407R**  
Ligature needle,  
right curved  
Unterbindungsnadel,  
rechts gebogen



**OP408R**  
Ligature needle,  
left curved  
Unterbindungsnadel,  
links gebogen

**OP386R-OP409R**  
Laryngeal instruments  
for use with handle  
OP380R  
Laryngoskopie-  
Instrumente  
für Handgriff OP380R

# Laryngology – Laryngologie

## Micro Laryngeal Instruments

### Mikro-Laryngoskopie Instrumente



#### OP380R

Handle for use  
with laryngeal instruments OP386R-OP409R  
Handgriff für  
Laryngoskopie-Instrumente OP386R-OP409R

- Laryngeal instruments with handle OP380R
- Laryngoskopie-Instrumente mit Handgriff OP380R

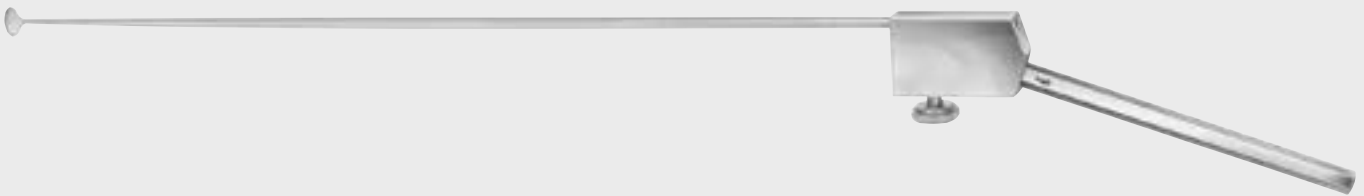

Laryngology  
Laryngologie

MILLIMETERS

# Laryngology - Laryngologie

## Laryngeal Polypus Forceps

### Kehlkopfpolypenzangen



Laryngology  
Laryngologie

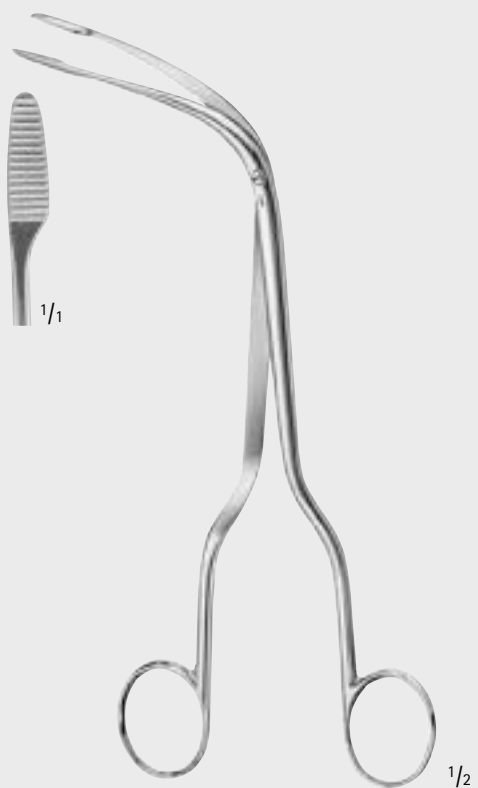

**FRAENKEL**  
**OP100R**  
205 mm, 8"

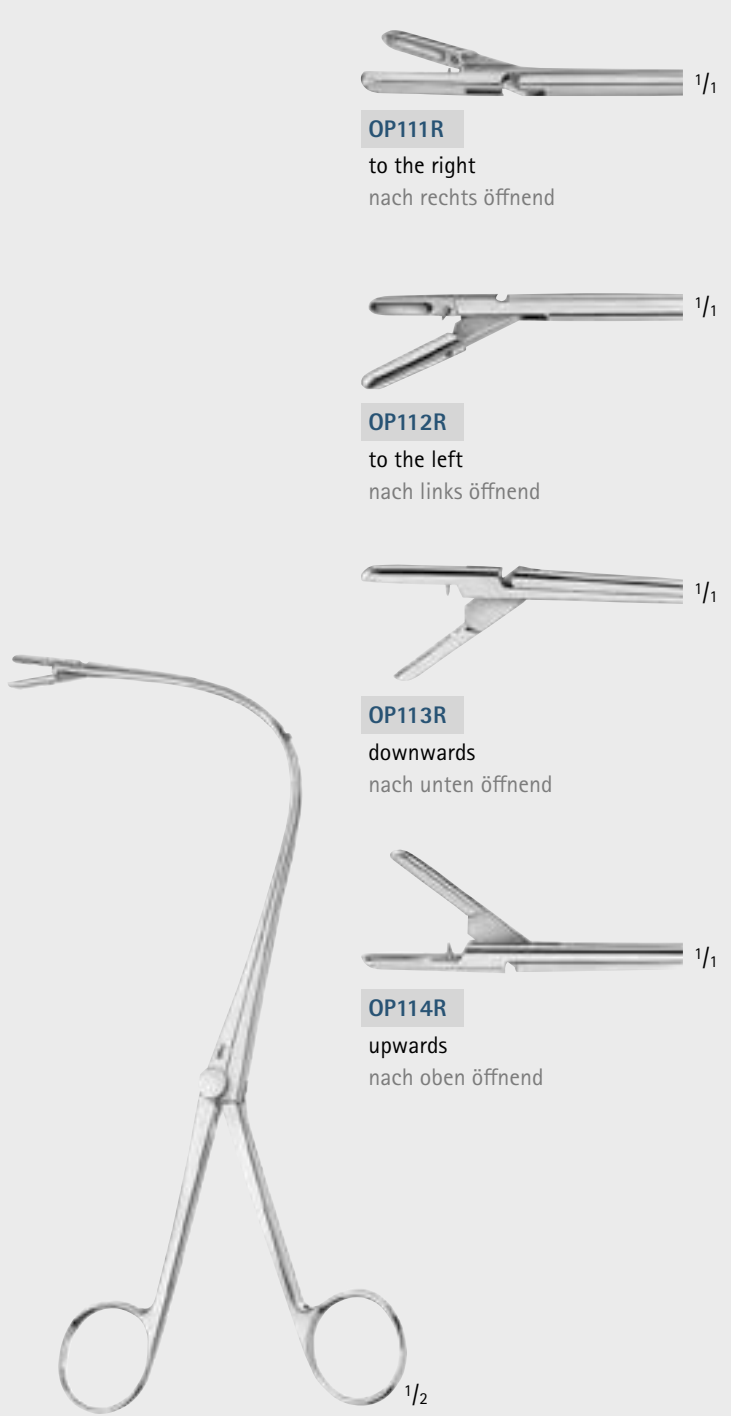

**OP111R**  
to the right  
nach rechts öffnend

**OP112R**  
to the left  
nach links öffnend

**OP113R**  
downwards  
nach unten öffnend

**OP114R**  
upwards  
nach oben öffnend

**JURASZ**  
**OP111R-OP114R**  
210 mm, 8 1/4"

## Laryngology - Laryngologie

### Laryngeal Forceps, Laryngectomy Scissors

### Kehlkopfzangen, Laryngofissurscheren

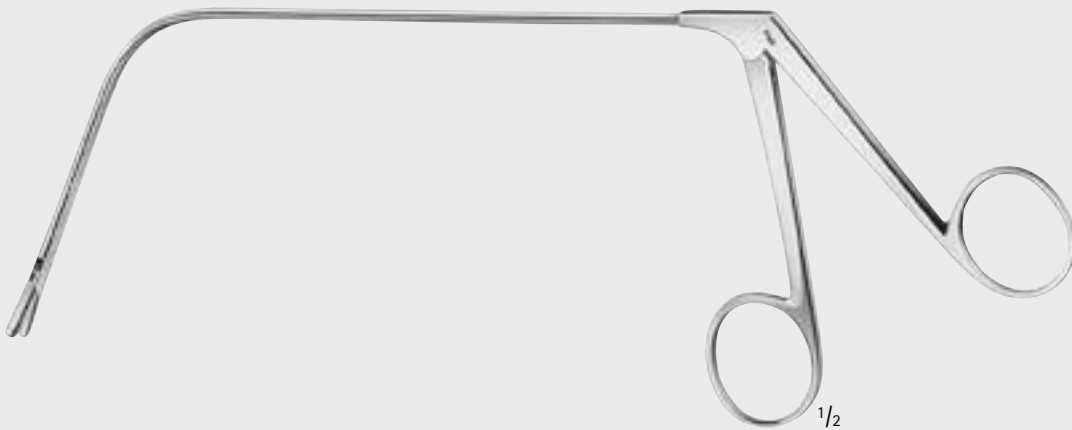

FRAENKEL

**OP120R**

Laryngeal forceps,  
both sides opening, oval  
Kehlkopfzange,  
doppelseitig öffnend, längs oval

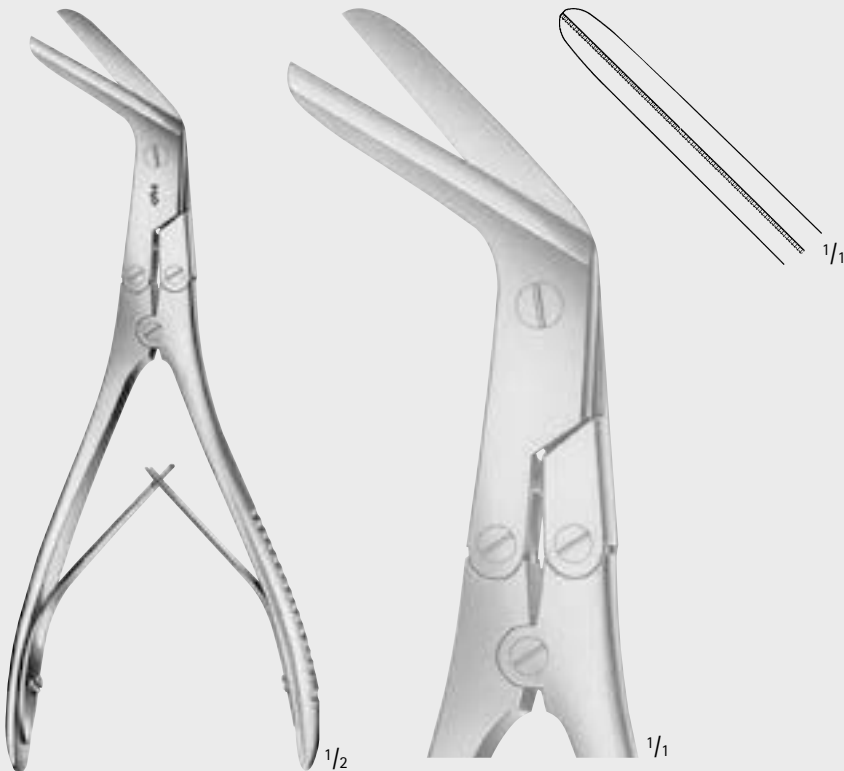

KILLIAN

**OP130R**

Laryngectomy scissors,  
double action  
Laryngofissurschere,  
doppelt übersetzt  
200 mm, 7 7/8"

# Laryngology - Laryngologie

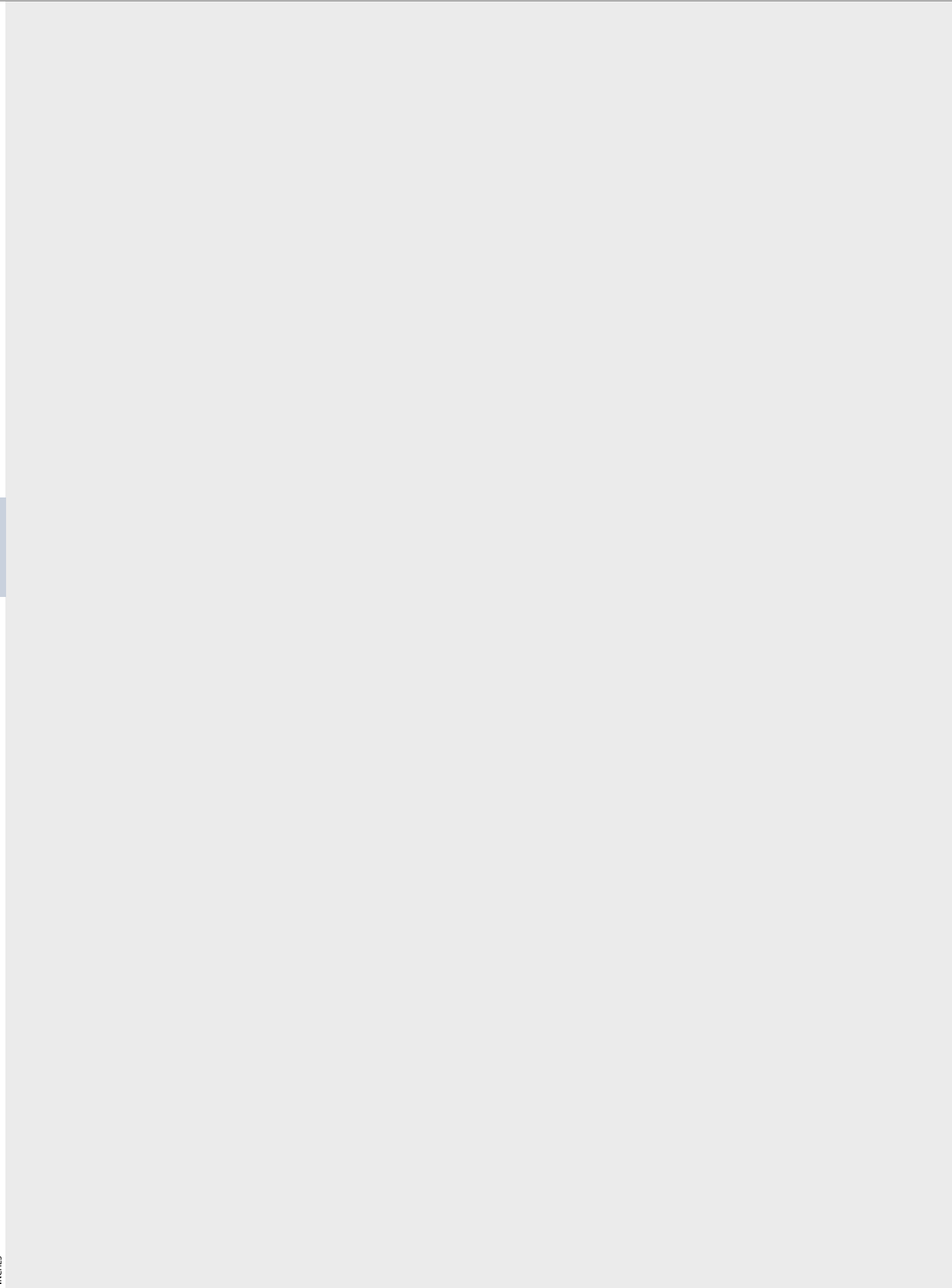



Micro Vascular Surgery  
Mikro-Gefäßchirurgie



## Micro Vascular Surgery – Mikro-Gefäßchirurgie

### Titanium Micro Instruments

### Titanium Mikro-Instrumente



#### Exceptional grasping qualities: Aesculap® Dia Dust®

All needle holder and forcep jaws are coated with Aesculap® Dia Dust®. This coating ensures that the inner surfaces provide the best possible performance in hardness and wear resistance. The texture of the jaws greatly increases its surface area, allowing you to grasp fine needles, sutures and soft tissue safely and securely. The needle quickly aligns itself in an ideal position in the rough surface. This results in a perfect grip that quite simply prevents any needle slippage.

#### Außergewöhnlicher Grip: Aesculap® Dia Dust®

Im Arbeitsende sind alle Nadelhalter und Pinzetten mit Aesculap® Dia Dust® beschichtet. Diese Beschichtung bringt für die Maulinnenflächen beste Ergebnisse in Härte und Verschleißfestigkeit. Die ungleichmäßige Oberflächenbeschaffenheit führt zu einer starken Oberflächenvergrößerung. Damit können Sie feine Nadeln, Nahtmaterialien und Weichgewebe sicher fassen. Zudem findet die Nadel in der rauen Oberfläche schnell ihre ideale Position. Dies führt zu einem perfektem Grip, der ein Wegrutschen oder Kippen der Nadel ganz einfach verhindert.



#### Unmistakable identification: the Aesculap color code.

The unique color coding means that you automatically pick up the right instrument.

#### Unverwechselbare Kennzeichnung: Aesculap Color Code.

Mit der intelligenten Farbcodierung greifen Sie automatisch und sicher zum richtigen Instrument.



#### Non-reflecting surface finish.

The non-reflecting surface finish provides optimal glare reduction for the end user.

#### Reflektionsarmes Oberflächendesign.

Die speziell verarbeitete Instrumentenoberfläche absorbiert das Operationslicht und sorgt so für ein angenehmes Operieren ohne Lichtreflektion.

## Micro Vascular Surgery – Mikro-Gefäßchirurgie

Titanium Micro Instruments

Titanium Mikro-Instrumente



### Fatigue-free lightness: Aesculap® TITANIUM micro instruments.

- The extremely light TITANIUM material is an advantage for lengthy operations. This helps to carry on operating over longer time periods with minimum fatigue.
- The non-magnetic material makes working with particularly fine needles easier for you.

### Ermüdungsfreie Leichtigkeit: Aesculap® TITANIUM Mikro-Instrumente.

- Das extrem leichte Titan kommt Ihnen vor allem bei lang andauernden Operationen entgegen. Wir unterstützen Sie dabei, möglichst ermüdungsfrei über längere Zeiträume hinweg zu arbeiten.
- Im Umgang mit besonders feinen Nadeln erleichtert Ihnen der nicht-magnetische Werkstoff das Arbeiten.

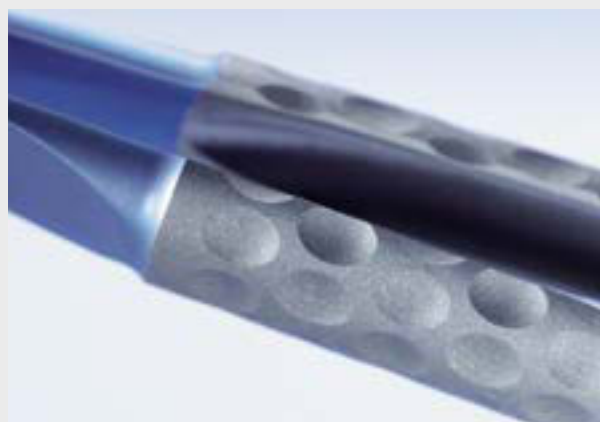

### Incomparable operating sensitivity: the Aesculap golfball design.

With its unique handling properties, the exclusive Aesculap golfball design is becoming more and more popular among surgeons.

Feel the difference. Ergonomic and stable, the handle design helps to combat fatigue. The unique geometry of the handle grants a previously unattainable degree of freedom in instrument handling.

### Unvergleichliches Operationsgefühl: Aesculap Golfball-Design.

Das exklusive Aesculap Golfball-Design findet dank des angenehmen Handlings immer mehr Freunde unter Chirurgen. Achten Sie auf Ihr Gefühl. Der Griff ist nicht nur ergonomisch und sicher, sondern er unterstützt Sie auch im ermüdungsfreien Arbeiten. Mit der ausgewogenen Griff-Geometrie des Instruments eröffnen Sie sich beim Handling einen nie dagewesenen Freiheitsgrad.

# Micro Vascular Surgery – Mikro-Gefäßchirurgie

## Titanium Micro Forceps

### Titanium Mikro-Pinzetten

INCHES  
Micro Vascular  
Mikro-Gefäß



**FM317T-FM337R**  
185 mm, 7 1/4"

**FM318T-FM338T**  
210 mm, 8 1/4"

Jaw type  
Maulform

Diam. of ring: 1 mm,  
straight  
Ring-Ø: 1 mm,  
gerade  
Dia Dust®



Platform tip,  
straight  
Fadenplatte,  
gerade  
Dia Dust®



DeBakey tip,  
1 mm  
DeBakey Zahnung,  
1 mm



Total length  
Gesamtlänge

185 mm  
7 1/4"

**FM317T**

**FM327T**

**FM337T**

210 mm  
8 1/4"

**FM318T**

**FM328T**

**FM338T**

# Micro Vascular Surgery – Mikro-Gefäßchirurgie

## Titanium Micro Needle Holders

### Titanium Mikro-Nadelhalter

with ratchet  
mit Sperre



Suture size  
Nahtmaterialgröße

7/0 and smaller  
7/0 und kleiner

5/0 and smaller  
5/0 und kleiner

Total length  
Gesamtlänge

185 mm  
7 1/4"



FM258T



FM238T

210 mm  
8 1/4"

FM259T

FM239T

without ratchet  
ohne Sperre



Suture size  
Nahtmaterialgröße

7/0 and smaller  
7/0 und kleiner

5/0 and smaller  
5/0 und kleiner

Total length  
Gesamtlänge

185 mm  
7 1/4"



FM252T



FM232T

210 mm  
8 1/4"

FM253T

FM233T



FM232T-FM258T

185 mm, 7 1/4"



FM233T-FM259T

210 mm, 8 1/4"

Micro Vascular  
Mikro-Gefäß

MILLIMETERS

# Micro Vascular Surgery – Mikro-Gefäßchirurgie

## Micro Scissors (Spring Type)

### Mikro-Federscheren

Micro Vascular  
Mikro-Gefäß

INCHES

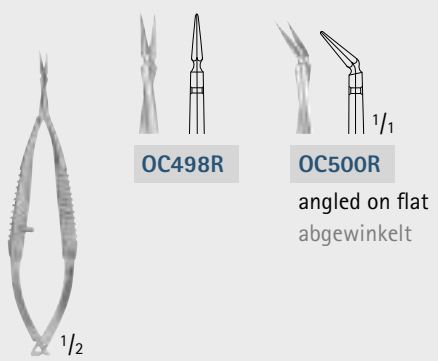

**OC498R**

**OC500R**

angled on flat  
abgewinkelt

VANNAS

**OC498R-OC500R**

85 mm, 3 1/4"

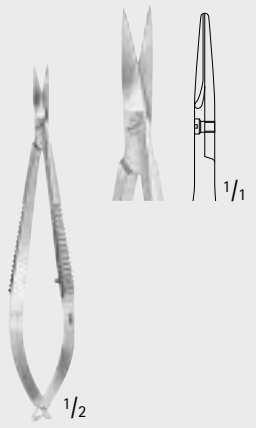

MC CLURE

**OC480R**

95 mm, 3 3/4"

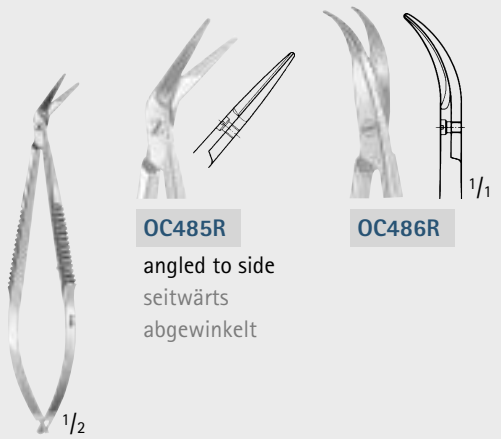

**OC485R**

**OC486R**

angled to side  
seitwärts  
abgewinkelt

CASTROVIEJO

**OC485R-OC486R**

95 mm, 3 3/4"

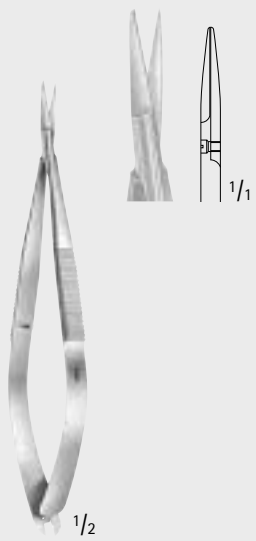

NOYES

**OC482R**

125 mm, 5"

# Micro Vascular Surgery – Mikro-Gefäßchirurgie

## Micro Scissors (Spring Type)

### Mikro-Federscheren

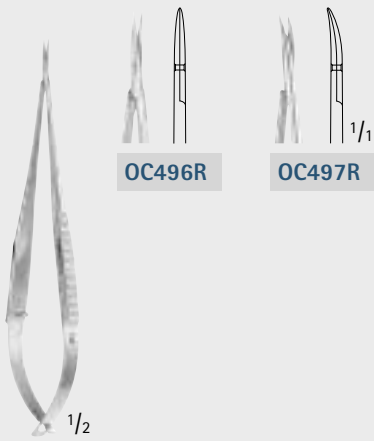

**OC496R-OC497R**

105 mm, 4 1/8"

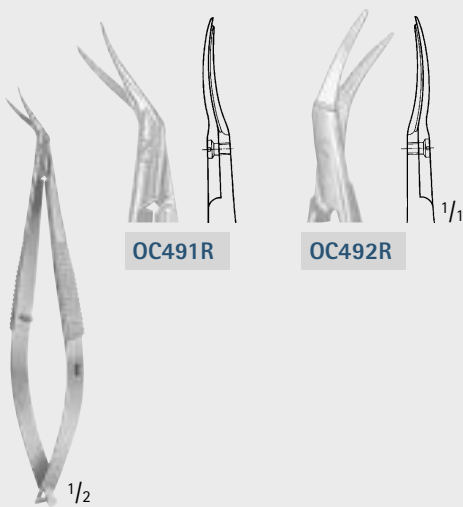

**CASTROVIEJO**

**OC491R-OC492R**

Eye scissors

Augenscheren

110 mm, 4 1/4"



# Micro Vascular Surgery – Mikro-Gefäßchirurgie

## Micro Scissors (Spring Type)

### Mikro-Federscheren

... with flat handle and cross-serration

- flat handles, sure grip due to cross-serration

... mit Flachgriffen und Karoprofil

- breite Flachgriffe mit griffigem Karoprofil
- sichere Handhabung

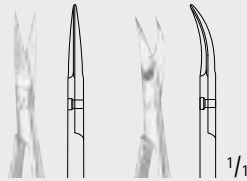

FD012R

FD013R



FD012R-FD013R

120 mm, 4 3/4"

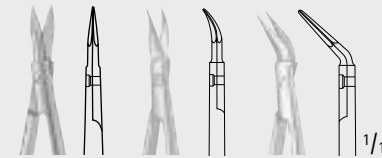

FD014R

FD015R

FD011R



VANNAS

FD011R-FD014R

120 mm, 4 3/4"

120 mm  
4 3/4"

120 mm  
4 3/4"

angled on flat  
abgewinkelt  
120 mm  
4 3/4"

Micro Vascular  
Mikro-Gefäß

### Vein scissors FD028R

for roughening vessel ends

- vessel cannot slip off
- clean, smooth cut

Venenschere FD028R

zum Auffrischen von Gefäßstümpfen

- kein Abgleiten des Gefäßes
- glatte, saubere Durchtrennung

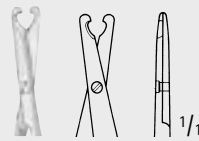

BIEMER

FD028R

Vein scissors  
Venenschere  
130 mm, 5 1/8"

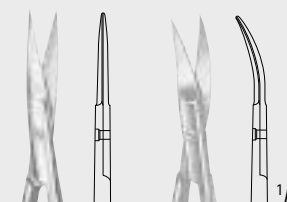

FD016R

FD017R



FD016R-FD017R

160 mm, 6 1/4"

INCHES



# Micro Vascular Surgery – Mikro-Gefäßchirurgie

## Micro Scissors (Spring Type)

### Mikro-Federscheren

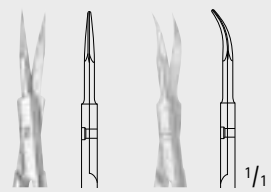
  
**FD018R**      **FD019R**

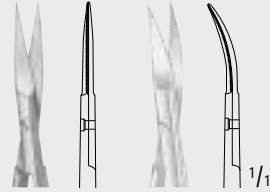

  
 $\frac{1}{2}$

**VANNAS**  
**FD018R-FD019R**  
 160 mm, 6  $\frac{1}{4}$ "

  
**FD020R**      **FD021R**

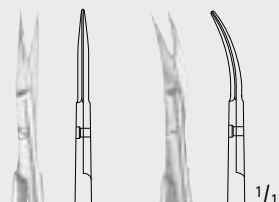

  
 $\frac{1}{2}$

**MILLESi**  
**FD020R-FD021R**  
 Blades serrated  
 Schneiden gezahnt  
 160 mm, 6  $\frac{1}{4}$ "

  
**YASARGIL**      **JACOBSON**  
**FD022R**      **FD023R**

  
 $\frac{1}{2}$

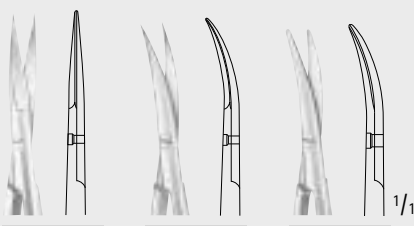
**FD022R-FD023R**  
 185 mm, 7  $\frac{1}{4}$ "

  
**FD100R**      **FD101R**      **FD103R**

  
 $\frac{1}{2}$

**FD100R-FD103R**  
 Micro dissecting scissors  
 Mikro-Präparierschere  
 145 mm, 5  $\frac{3}{4}$ "



# Micro Vascular Surgery – Mikro-Gefäßchirurgie

## Micro Scissors (Spring Type)

### Mikro-Federscheren

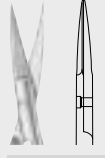

**FM010R**  
sharp/sharp  
spitz/spitz



**FM011R**  
sharp/sharp  
spitz/spitz

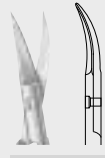

**FM012R**  
sharp/blunt  
spitz/stumpf



**FM013R**  
blunt/blunt  
stumpf/stumpf



**FM014R**  
probe pointed/sharp  
Kugel/spitz

MÜLLER

**FM010R-FM014R**

120 mm, 4 3/4"

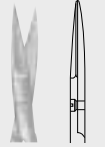

**FM040R**  
sharp/sharp  
spitz/spitz



**FM041R**  
sharp/sharp  
spitz/spitz

MÜLLER

**FM040R-FM041R**

170 mm, 6 3/4"

# Micro Vascular Surgery – Mikro-Gefäßchirurgie

## Micro Scissors (Spring Type)

### Mikro-Federscheren



1/1  
sharp/sharp  
spitz/spitz

1/2

**FM042R**  
Micro scissors  
Mikro-Schere  
180 mm, 7"



1/1  
sharp/sharp  
spitz/spitz

1/2

**FD251R**  
Micro scissors  
Mikro-Schere  
180 mm, 7"



1/1  
1 blade probe pointed  
1 Blatt mit Knopf

1/2

**FM043R**  
Micro scissors  
Mikro-Schere  
180 mm, 7"



1/1  
sharp/sharp,  
1 blade serrated  
spitz/spitz,  
1 Blatt gezahnt

1/2

**FD252R**  
Micro ligature scissors  
for suture material 6/0 - 8/0  
Mikro-Fadenschere  
für Nahtmaterial von 6/0 bis 8/0  
180 mm, 7"



# Micro Vascular Surgery – Mikro-Gefäßchirurgie

## Micro Scissors (Spring Type)

### Mikro-Scheren

- Instrument length depends on the blade length or angle.
- Die Instrumentenlänge variiert in Abhängigkeit der Blattlänge oder des Blattwinkels.

- Delicate blade 10 mm
- Sehr feines Blatt 10 mm



**FM437R**  
25°



**FM438R**  
45°



**FM439R**  
60°



**FM440R**  
90°



**FM441R**  
125°



**FM442R**  
straight  
gerade



**FM436R**  
curved on flat  
aufgebogen

- Ultra delicate blade 7 mm
- Extrem feines Blatt 7 mm



**FM431R**  
25°



**FM432R**  
45°



**FM433R**  
60°



**FM434R**  
90°



**FM435R**  
125°



**FM444R**  
straight  
gerade



**FM430R**  
curved on flat  
aufgebogen



**FM430R-FM444R**  
165 mm, 6 1/2"

Micro Vascular  
Mikro-Gefäß

INCHES

# Micro Vascular Surgery – Mikro-Gefäßchirurgie

## Micro Scissors (Spring Type)

### Mikro-Scheren

- Delicate blade 10 mm
- Sehr feines Blatt 10 mm



**FM482R**  
25°



**FM483R**  
45°



**FM484R**  
60°



**FM485R**  
90°



**FM486R**  
125°



**FM488R**  
straight  
gerade



**FM481R**  
curved on flat  
aufgebogen

- Ultra delicate blade 7 mm
- Extrem feines Blatt 7 mm

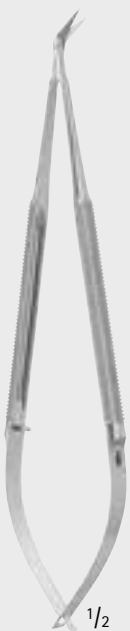

**FM481R-FM508R**

165 mm, 6 1/2"



**FM504R**  
25°



**FM505R**  
45°



**FM506R**  
60°



**FM507R**  
90°



**FM508R**  
125°



**FM503R**  
curved on flat  
aufgebogen



# Micro Vascular Surgery – Mikro-Gefäßchirurgie

## Micro Suture Tying Forceps, Jewelers Forceps

### Mikro-Knüpfpinzetten, Uhrmacher-Pinzetten



0.2 mm

1/2

1/1

**BD330R**  
110 mm, 4 1/4"

0.15 mm

1/2

1/1

**BD331R**  
110 mm, 4 1/4"

0.3 mm

1/2

1/1

**BD329R**  
110 mm, 4 1/4"



0.2 mm

1/2

1/1

**BD333R**  
115 mm, 4 1/2"

0.4 mm

1/2

1/1

1 x 2 teeth  
1 x 2 Zähne

**BD343R**  
115 mm, 4 1/2"

0.3 mm

1/2

1/1

**BD335R**  
135 mm, 5 1/4"

0.4 mm

1/2

1/1

1 x 2 teeth  
1 x 2 Zähne

**BD345R**  
135 mm, 5 1/4"

# Micro Vascular Surgery – Mikro-Gefäßchirurgie

## Micro Suture Tying Forceps

### Mikro-Knüpfpinzetten

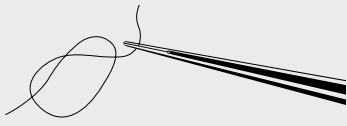

with platform tips  
mit Plateau an den Spitzen

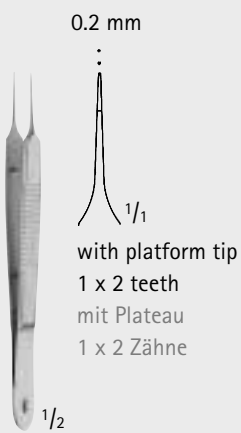

BONNER MODELL

**BD505R**

95 mm, 3 3/4"

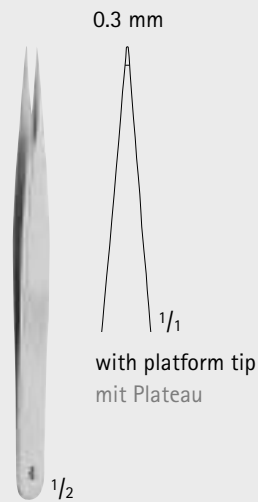

**BD338R**

120 mm, 4 3/4"

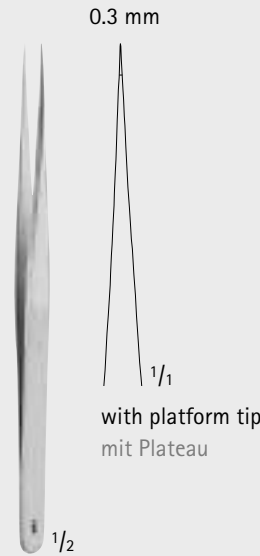

WISE

**BD336R**

135 mm, 5 1/4"

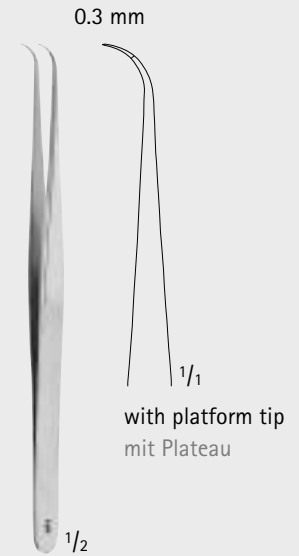

WISE

**BD337R**

135 mm, 5 1/4"

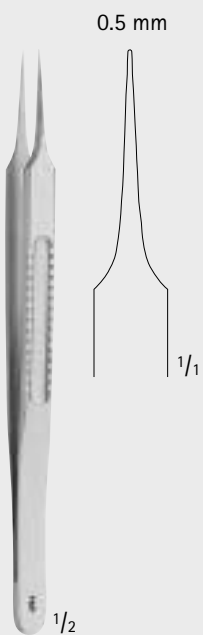

LAZAR

**BD260R**

155 mm, 6 1/8"

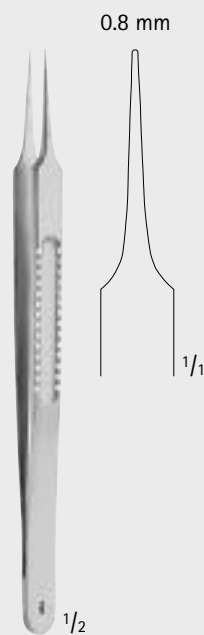

LAZAR

**BD261R**

155 mm, 6 1/8"

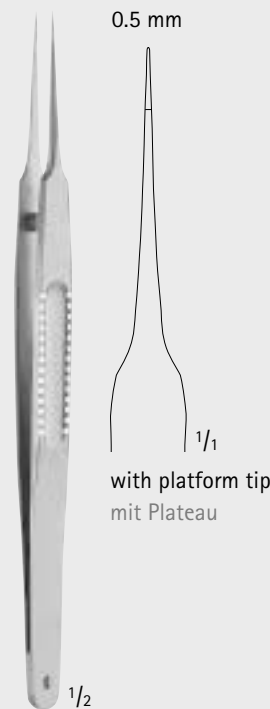

**BD264R**

185 mm, 7 1/4"

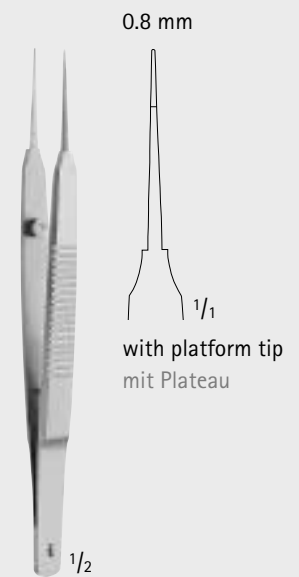

AUSTIN

**BD340R**

140 mm, 5 1/2"



Micro Vascular  
Mikro-Gefäß

MILLIMETERS

# Micro Vascular Surgery – Mikro-Gefäßchirurgie

## Micro Suture Tying Forceps

### Mikro-Knüpfpinzetten



... with round handles

- Round handles allow turning manipulations between the fingers.
- Optimum balance individually for each instrument due to solid or hollowed-out handles.

... mit Rundgriffen

- Rundgriffe erlauben Drehbewegungen zwischen den Fingern.
- Optimale Balance, individuell je nach Instrument, durch volle oder gehöhlte Griffpartien.

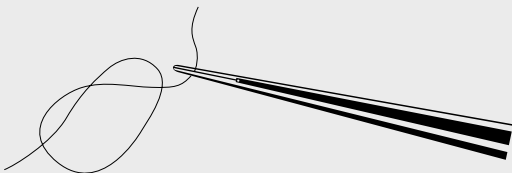

with platform tips

mit Plateau an den Spitzen

Micro Vascular  
Mikro-Gefäß

INCHES



# Micro Vascular Surgery – Mikro-Gefäßchirurgie

Micro Vessel Dilator

Mikro-Gefäßdilator

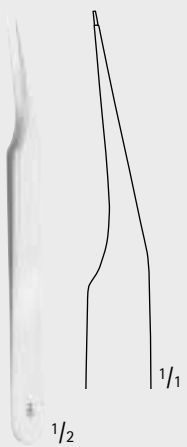

**FB130R**

Micro vessel dilator  
Mikro-Gefäßdilator  
115 mm, 4 1/2"



## Micro Vascular Surgery – Mikro-Gefäßchirurgie

Dia Dust® Micro Forceps, Micro Ring Forceps, Atraumatic Forceps

Dia Dust® Mikro-Pinzetten, Mikro-Ringpinzette, Atraumatische Pinzette



Micro Vascular  
Mikro-Gefäß

- The diamond dust coating ensures an even harder and more wear resistant surface on the inside of the jaws. Moreover, the structure of the Dia Dust® coating guarantees a reliable grip for fine needles and sutures, as well as for tissue.
- Die Diamantstaubbeschichtung sorgt für eine noch härtere und verschleißfestere Maulinnenfläche. Darüber hinaus garantiert die Struktur der Dia Dust®-Beschichtung ein zuverlässiges Fassen von feinen Nadeln und Nahtmaterialien sowie von Weichgewebe.

■ Dia Dust®

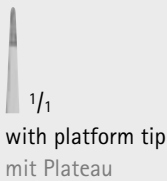

**FD253R**  
Micro dissecting forceps  
Anatomische Mikro-Pinzette  
180 mm, 7"

■ Dia Dust®



**FD255R-FD256R**  
Micro tissue forceps  
Chirurgische Mikro-Pinzetten  
180 mm, 7"



**FM047R**  
Micro ring forceps  
Mikro-Ringpinzette  
180 mm, 7"

■ ERGOPLANT



**DX303R**  
Micro forceps  
Mikro-Pinzette  
180 mm, 7"

■ ATRAUMATA®

Toothing COOLEY  
  
COOLEY Zahnung

# Micro Vascular Surgery – Mikro-Gefäßchirurgie

## Micro Needle Holders

### Mikro-Nadelhalter



... with round handles

- Round handles allow turning manipulations between the fingers.
- Optimum balance individually for each instrument due to solid or hollowed-out handles.

... mit Rundgriffen

- Rundgriffe erlauben Drehbewegungen zwischen den Fingern.
- Optimale Balance, individuell je nach Instrument, durch volle oder gehöhlte Griffpartien.

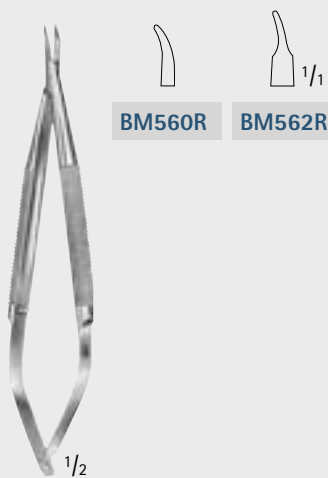

**BM560R**

**BM562R**

BARRAQUER

**BM560R-BM562R**

without ratchet  
ohne Sperre  
120 mm, 4 3/4"



**FD230R**

**FD231R**

BARRAQUER

**FD230R-FD231R**

without ratchet  
ohne Sperre  
120 mm, 4 3/4"



**FD232R**

**FD233R**

BARRAQUER

**FD232R-FD233R**

with ratchet  
mit Sperre  
120 mm, 4 3/4"

# Micro Vascular Surgery – Mikro-Gefäßchirurgie

## Micro Needle Holders

### Mikro-Nadelhalter



Diagram showing the needle holder and its components: a straight needle (FD240R) and a curved needle (FD241R) with a 1/1 curvature. The holder is labeled REILL and has a 1/2 inch tip.

**FD240R** **FD241R**

**REILL**  
**FD240R-FD241R**  
without ratchet  
ohne Sperre  
150 mm, 6"

Diagram showing the needle holder and its components: a straight needle (FD242R) and a curved needle (FD243R) with a 1/1 curvature. The holder has a ratchet and a 1/2 inch tip.

**FD242R** **FD243R**

**FD242R-FD243R**  
with ratchet  
mit Sperre  
150 mm, 6"

Diagram showing the needle holder and its components: a straight needle (FD244R) and a curved needle (FD245R) with a 1/1 curvature. The holder has a 1/2 inch tip.

**FD244R** **FD245R**

**FD244R-FD245R**  
without ratchet  
ohne Sperre  
185 mm, 7 1/4"

Diagram showing the needle holder and its components: a straight needle (FD246R) and a curved needle (FD247R) with a 1/1 curvature. The holder has a ratchet and a 1/2 inch tip.

**FD246R** **FD247R**

**FD246R-FD247R**  
with ratchet  
mit Sperre  
185 mm, 7 1/4"

# Micro Vascular Surgery – Mikro-Gefäßchirurgie

## Micro Needle Holders

### Mikro-Nadelhalter



BM563R BM564R

1/2

**CASTROVIEJO**  
**BM563R-BM564R**  
 with ratchet  
 mit Sperre  
 145 mm, 5 3/4"

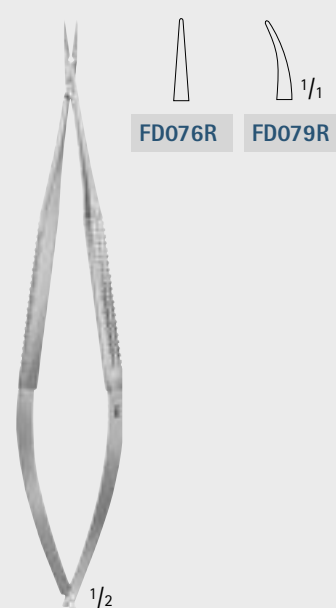

FD076R FD079R

1/2

**FD076R-FD079R**  
 without ratchet  
 ohne Sperre  
 160 mm, 6 1/4"



FD080R FD081R

1/2

**FD080R-FD081R**  
 without ratchet  
 ohne Sperre  
 185 mm, 7 1/4"



FD045R FD046R

1/2

**JACOBSON**  
**FD045R-FD046R**  
 185 mm, 7 1/4"



1/1

**FD048R**  
 with ratchet  
 mit Sperre  
 200 mm, 7 7/8"



# Micro Vascular Surgery – Mikro-Gefäßchirurgie

## Micro Needle Holders

### Mikro-Nadelhalter



with locking mechanism  
mit Anreichverriegelung

1/2

MÜLLER

**FM021R**

145 mm, 5 3/4"



with locking mechanism  
mit Anreichverriegelung

1/2

MÜLLER

**FM061R**

180 mm, 7"

Micro Vascular  
Mikro-Gefäß

# Micro Vascular Surgery – Mikro-Gefäßchirurgie

## Dia Dust® Micro Needle Holders

### Dia Dust® Mikro-Nadelhalter



- The diamond dust coating ensures an even harder and more wear resistant surface on the inside of the jaws. Moreover, the structure of the Dia Dust® coating guarantees a reliable grip for fine needles and sutures, as well as for tissue.
- Die Diamantstaubbeschichtung sorgt für eine noch härtere und verschleißfestere Maulinnenfläche. Darüber hinaus garantiert die Struktur der Dia Dust®-Beschichtung ein zuverlässiges Fassen von feinen Nadeln und Nahtmaterialien sowie von Weichgewebe.



Micro Vascular  
Mikro-Gefäß

MILLIMETERS

**FD258R**    **FD259R**

**FD258R-FD259R**  
with ratchet  
Suture size: 7/0 and smaller  
mit Sperre  
Nahtmaterialgröße: 7/0 und kleiner  
180 mm, 7"

**FM236R**  
with ratchet  
for suture material 5/0 and smaller  
mit Sperre  
für Nahtmaterial 5/0 und kleiner  
210 mm, 8 1/4"

**FM276R**  
without ratchet  
for suture material 5/0 and smaller  
ohne Sperre  
für Nahtmaterial 5/0 und kleiner  
210 mm, 8 1/4"

## Micro Vascular Surgery – Mikro-Gefäßchirurgie

### Dia Dust® Micro Needle Holders

### Dia Dust® Mikro-Nadelhalter



- The diamond dust coating ensures an even harder and more wear resistant surface on the inside of the jaws. Moreover, the structure of the Dia Dust® coating guarantees a reliable grip for fine needles and sutures, as well as for tissue.
- Die Diamantstaubbeschichtung sorgt für eine noch härtere und verschleißfestere Maulinnenfläche. Darüber hinaus garantiert die Struktur der Dia Dust®-Beschichtung ein zuverlässiges Fassen von feinen Nadeln und Nahtmaterialien sowie von Weichgewebe.

Micro Vascular  
Mikro-Gefäß



**FM520R-FM524R**

120 mm, 4 3/4"



**FM522R-FM528R**

145 mm, 5 3/4"



**FM521R-FM529R**

160 mm, 6 1/4"



**FM218R-FM530R**

185 mm, 7 1/4"

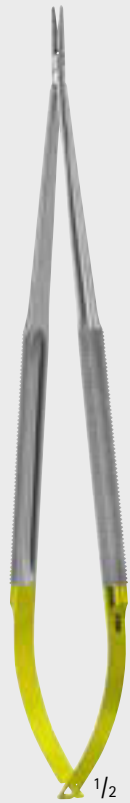

**FM221R-FM531R**

210 mm, 8 1/4"







# Micro Vascular Surgery – Mikro-Gefäßchirurgie

## Dia Dust® Micro Needle Holders

### Dia Dust® Mikro-Nadelhalter



with ratchet  
mit Sperre

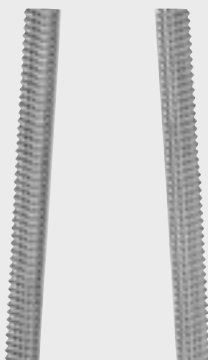

Total length Gesamtlänge	Suture size Nahtmaterialgröße			
	7/0 and smaller 7/0 und kleiner	5/0 and smaller 5/0 und kleiner	4/0 and smaller 4/0 und kleiner	4/0 and smaller 4/0 und kleiner
120 mm 4 3/4"	 <b>FM520R</b>			
145 mm 5 3/4"		<b>FM522R</b>		
160 mm 6 1/4"	<b>FM521R</b>	<b>FM523R</b>		
185 mm 7 1/4"	<b>FM563R</b>	<b>FM564R</b>	<b>FM218R</b>	
210 mm 8 1/4"	<b>FM565R</b>	<b>FM566R</b>	<b>FM228R</b>	<b>FM221R</b>

without ratchet  
ohne Sperre



Total length Gesamtlänge	Suture size Nahtmaterialgröße	
	7/0 and smaller 7/0 und kleiner	5/0 and smaller 5/0 und kleiner
120 mm 4 3/4"	 <b>FM524R</b>	
145 mm 5 3/4"		<b>FM528R</b>
160 mm 6 1/4"	<b>FM525R</b>	<b>FM529R</b>
185 mm 7 1/4"	<b>FM526R</b>	<b>FM530R</b>
210 mm 8 1/4"	<b>FM527R</b>	<b>FM531R</b>

Micro Vascular  
Mikro-Gefäß

MILLIMETERS

## Micro Vascular Surgery – Mikro-Gefäßchirurgie

### Dia Dust® Micro Needle Holders

### Dia Dust® Mikro-Nadelhalter



- The diamond dust coating ensures an even harder and more wear resistant surface on the inside of the jaws. Moreover, the structure of the Dia Dust® coating guarantees a reliable grip for fine needles and sutures, as well as for tissue.
- Die Diamantstaubbeschichtung sorgt für eine noch härtere und verschleißfestere Maulinnenfläche. Darüber hinaus garantiert die Struktur der Dia Dust®-Beschichtung ein zuverlässiges Fassen von feinen Nadeln und Nahtmaterialien sowie von Weichgewebe.

Micro Vascular  
Mikro-Gefäß



**FM541R-FM546R**

145 mm, 5 3/4"



**FM540R-FM545R**

170 mm, 6 3/4"



**FM542R-FM547R**

185 mm, 7 1/4"



**FM543R-FM548R**

210 mm, 8 1/4"



# Micro Vascular Surgery – Mikro-Gefäßchirurgie

## Dia Dust® Micro Needle Holders

### Dia Dust® Mikro-Nadelhalter

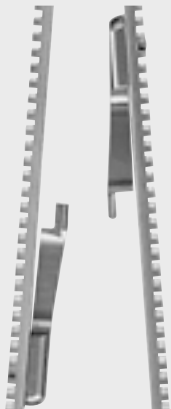

with ratchet  
mit Sperre

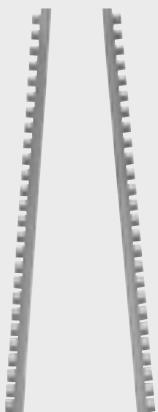

Total length Gesamtlänge	Suture size Nahtmaterialgröße	
	7/0 and smaller 7/0 und kleiner	5/0 and smaller 5/0 und kleiner
145 mm 5 3/4"		 <b>FM541R</b>
170 mm 6 3/4"	<b>FM540R</b>	
185 mm 7 1/4"		<b>FM542R</b>
210 mm 8 1/4"		<b>FM543R</b>

without ratchet  
ohne Sperre



Total length Gesamtlänge	Suture size Nahtmaterialgröße	
	7/0 and smaller 7/0 und kleiner	5/0 and smaller 5/0 und kleiner
145 mm 5 3/4"		 <b>FM546R</b>
170 mm 6 3/4"	<b>FM545R</b>	
185 mm 7 1/4"		<b>FM547R</b>
210 mm 8 1/4"		<b>FM548R</b>

Micro Vascular  
Mikro-Gefäß

MILLIMETERS

# Micro Vascular Surgery – Mikro-Gefäßchirurgie

## DUROGRIP® Micro Needle Holders

### DUROGRIP® Mikro-Nadelhalter

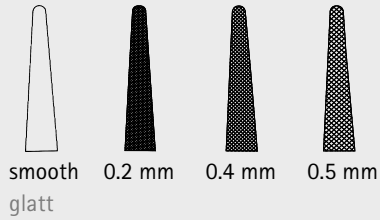
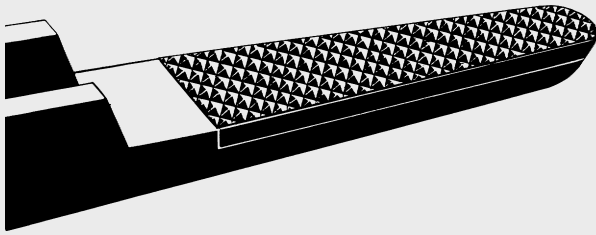

smooth 0.2 mm 0.4 mm 0.5 mm  
glatt

- Aesculap needle holders have jaws with tungsten carbide inserts and according to the use required the resp. structure can be chosen. A smooth jaw surface as well as 3 different serrations ensure a sure „grip“ of the resp. needle.
- Aesculap Nadelhalter sind durch die Struktur der Hartmetall-Maulteile auf das jeweilige, indikationsbezogene Nahtmaterial abgestimmt. Eine glatte Maulfläche sowie 3 verschiedene Haftprofile garantieren den sicheren „Grip“ der jeweiligen Nadel.

- We recommend tungsten carbide inserts
  - with smooth jaw surface for suture material 9/0 - 11/0
  - with 0.2 mm pitch of serration for suture material 6/0 - 10/0
  - 0.4 mm 4/0 - 6/0
  - 0.5 mm up to 3/0
- Wir empfehlen Hartmetall-Maulteile
  - mit glatter Fläche für Nahtmaterial 9/0 - 11/0
  - mit Teilung 0,2 mm für Nahtmaterial 6/0 - 10/0
  - 0,4 mm 4/0 - 6/0
  - 0,5 mm bis 3/0



#### DUROGRIP® Needle holders with tungsten carbide inserts

- Identification:
  - gold-plated handle ends
- DUROGRIP® Nadelhalter mit Hartmetall-Plättchen
- Kennzeichnung:
  - Vergoldete Branchenenden

Micro Vascular  
Mikro-Gefäß

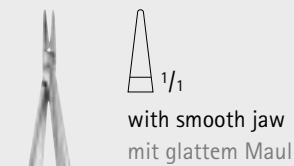

1/2  
CASTROVIEJO  
**BM001R**  
145 mm, 5 3/4"

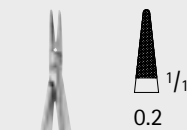

1/2  
CASTROVIEJO  
**BM002R**  
145 mm, 5 3/4"



1/2  
**BM003R**  
170 mm, 6 3/4"

# Micro Vascular Surgery – Mikro-Gefäßchirurgie

DUROGRIP® Micro Needle Holders

DUROGRIP® Mikro-Nadelhalter

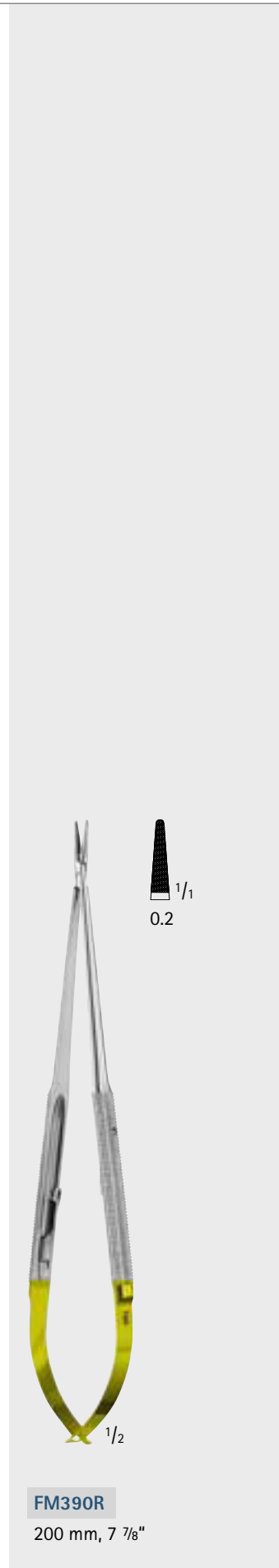
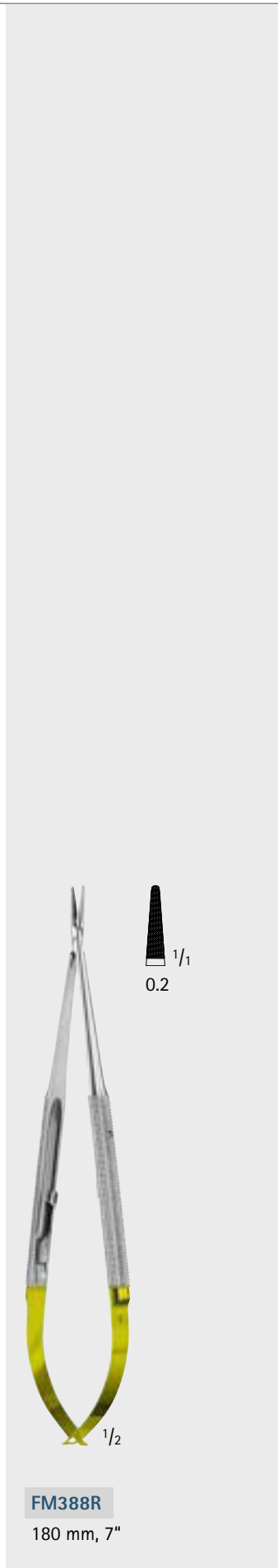
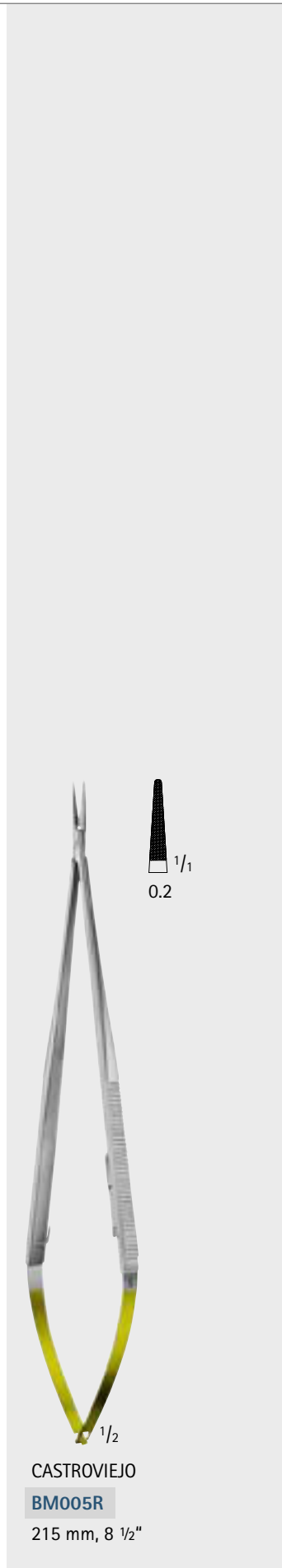
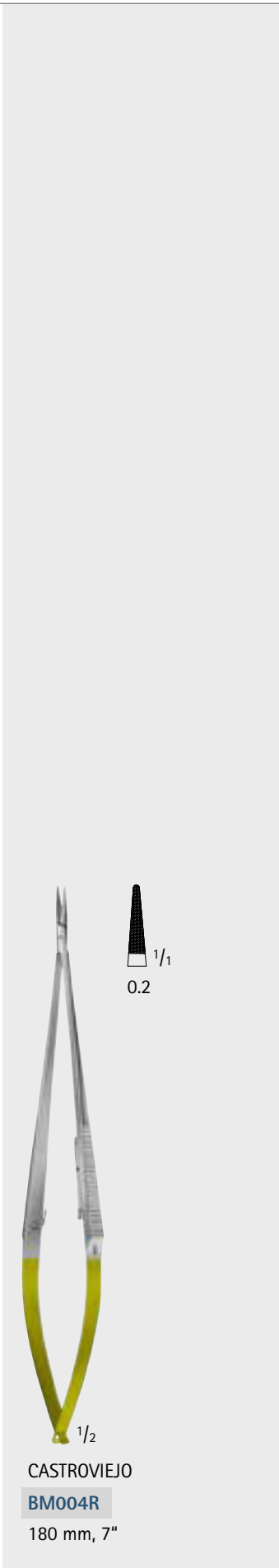

# Micro Vascular Surgery – Mikro-Gefäßchirurgie

## Mini Vessel Clips and Approximators

### Mini Gefäßclips und Approximatoren

**for temporary occlusion**

- Blade gripping surface with oblique serrations for safe but careful gripping of vessels.
- Fixed closing pressure.
- Closing force is measured at 1/3 of the blades at 1 mm opening (see illustration).

**für temporären Gebrauch**

- Maulinnenflächen schräg gerieft, für schonendes, sicheres Festhalten der Gefäße.
- Fest eingestellter Schließdruck.
- Schließkraft-Ermittlung: bei 1/3 der Gesamtmaullänge von vorn und einer Maulöffnung von 1 mm (siehe Zeichnung).

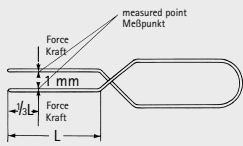

**BIEMER**

Art. No. Art. Nr.		Jaw opening Maulöffnung	Jaw length Maullänge	Closing force Schließkraft	Applying forceps Anlegepinzette
FD560R		4 mm	6 mm	30 - 40 g (0.29 - 0.39 N)	FD568R or FD569R FD568R oder FD569R
FD561R		5 mm	9 mm	30 - 40 g (0.29 - 0.39 N)	FD568R or FD569R FD568R oder FD569R
FD562R		5 mm	9 mm	20 - 25 g (0.20 - 0.25 N)	FD568R or FD569R FD568R oder FD569R

(identified by gold-plated spring ends)

for vessels diam. 0.5 - 2.0 mm.

(gekennzeichnet durch vergoldete Federenden)

für Gefäße mit Ø 0,5 - 2,0 mm.

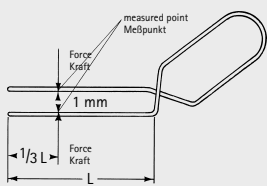

**MEHDORN**

Art. No. Art. Nr.		Jaw opening Maulöffnung	Jaw length Maullänge	Closing force Schließkraft	Applying forceps Anlegepinzette
FD552R		2 mm	4 mm	10 - 15 g (0.10 - 0.15 N)	FD578R
FD554R		2 mm	4 mm	15 - 20 g (0.15 - 0.20 N)	FD578R
FD556R		3 mm	6 mm	10 - 15 g (0.10 - 0.15 N)	FD578R
FD558R		3 mm	6 mm	15 - 20 g (0.15 - 0.20 N)	FD578R

(identified by gold-plated spring ends)

for vessels diam. 0.5 - 1.5 mm.

(gekennzeichnet durch vergoldete Federenden)

für Gefäße mit Ø 0,5 - 1,5 mm.

Micro Vascular  
Mikro-Gefäß

INCHES

## Micro Vascular Surgery - Mikro-Gefäßchirurgie

Applying Forceps for Vessel Clips and Approximators

Anlegepinzetten für Gefäßclips und Approximatoren

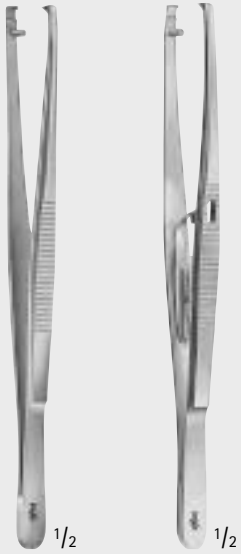

**FD568R**

without lock  
ohne Schloss

**FD569R**

with lock  
mit Schloss

BIEMER

**FD568R-FD569R**

Applying forceps for BIEMER vessel clips and BIEMER-MÜLLER and MÜLLER approximators  
Anlegepinzetten für Gefäßclips nach BIEMER und Approximatoren nach BIEMER-MÜLLER und MÜLLER  
140 mm, 5 1/2"



Various positions of clips possible  
Die Position des Clips ist variabel

MEHDORN

**FD578R**

Applying forceps for MEHDORN vessel clips  
Anlegepinzette für Gefäßclips nach MEHDORN  
150 mm, 6"

Micro Vascular  
Mikro-Gefäß

MILLIMETERS

# Micro Vascular Surgery – Mikro-Gefäßchirurgie

## Mini Vessel Clips and Approximators

### Mini Gefäßclips und Approximatoren

**For micro vascular anastomosis in the superficial range**

- Blade gripping surface with oblique serrations for careful but safe holding of the vessel ends.
- Fixed closing pressure.
- Adjustable distance between the clips and automatic fixation by tilting.
- Even when applied, the lightweight construction allows easy, distortionless turning and makes suturing possible on the other side of the vessel.

**Für Mikro-Gefäßanastomosen im oberflächlichen Bereich**

- Maulinnenflächen schräg gerieft, für schonendes, sicheres Festhalten der Gefäßenden.
- Fest eingestellter Schließdruck.
- Der Abstand zwischen den Clips ist durch einfaches Verschieben variabel und wird durch Verkantung selbsttätig fixiert.
- Die leichte Konstruktion (geringes Gewicht, kleine Dimension) ermöglicht im angelegten Zustand einfaches, verzerrungsfreies Umdrehen, um auf der unteren Gefäßseite weiterzunähen.

**BIEMER-MÜLLER**

Art. No. Art. Nr.		Jaw opening Maul- öffnung	Jaw length Maul- länge	Closing force Schließkraft	Applying forceps Anlege- pinzette
FD611R		3 mm	9 mm	25 - 30 g (0.25 - 0.29 N)	FD568R or / oder FD 569R
FD612R		3 mm	9 mm	25 - 30 g (0.25 - 0.29 N)	FD568R or / oder FD569R
FD613R		4 mm	9 mm	25 - 30 g (0.25 - 0.29 N)	FD568R or / oder FD569R
FD614R		3 mm	9 mm	25 - 30 g (0.25 - 0.29 N)	FD568R or / oder FD569R
FD615R		3 mm	4.5 mm	25 - 30 g (0.25 - 0.29 N)	FD568R or / oder FD569R
BIEMER FD571R		2 mm	6 mm	30 - 40 g (0.29 - 0.39 N)	FD572R

Micro approximators  
Mikro-Approximatoren

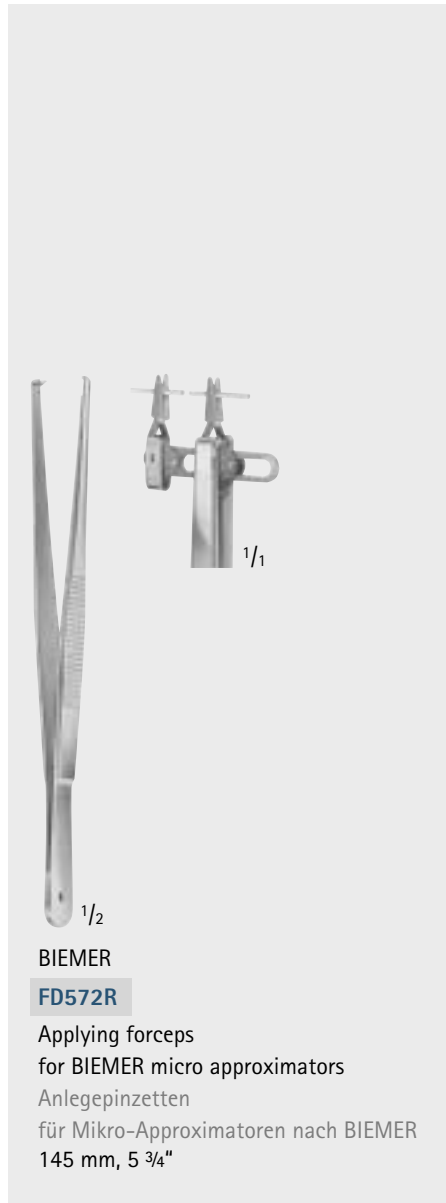

BIEMER  
**FD572R**

Applying forceps  
for BIEMER micro approximators  
Anlegepinzetten  
für Mikro-Approximatoren nach BIEMER  
145 mm, 5 3/4"

**BIEMER**

**FD570R**

Set, complete  
consisting of: FD571R and FD572R

Set, komplett  
bestehend aus: FD571R und FD572R



## Micro Vascular Surgery – Mikro-Gefäßchirurgie

## Approximators

## Approximatoren

For micro vascular anastomosis in the deeper range,  
also for experimental surgery

- Blade gripping surface with oblique serrations for careful but safe holding of the vessel ends.
- The pressure measure is adjusted with wrench FD576R.
- The distance between the clips is variable and fixed with wrench FD576R.

Für Mikro-Gefäßanastomosen im tieferen Bereich,  
außerdem für die experimentelle Chirurgie

- Maulinnenflächen schräg gerieft, für schonendes, sicheres Festhalten der Gefäßenden.
- Der Schließdruck wird mit dem Schlüssel FD576R eingestellt.
- Der Abstand zwischen den Clips ist variabel und wird mit dem Schlüssel FD576R fixiert.

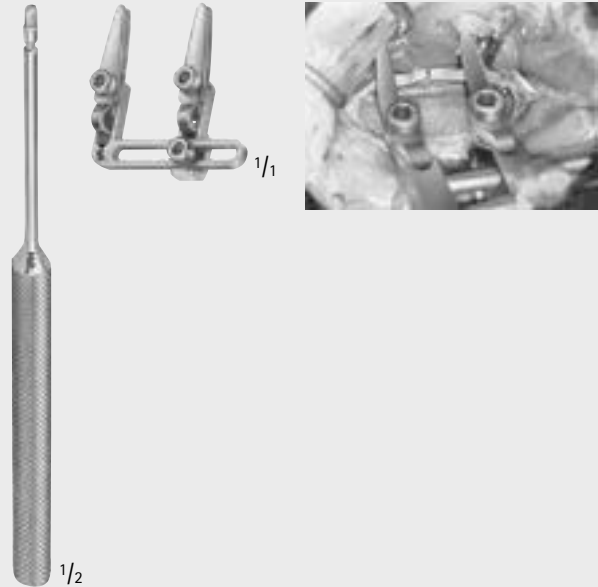

**FD575R**

Approximator, complete  
with wrench FD576R

Approximatoren komplett,  
mit Schlüssel FD576R

For safe adaption of nerve anastomoses

- Piercing the nerve centre with fine needles prevents strong pathological changes.
- Needles can be exchanged with wrench FD576R.
- Distance between the needles is variable and can be fixed with wrench FD576R.

Zur sicheren Adaption bei Nervenastomosen

- Das Durchstrecken des Nervenzentrum mit feinen Nadeln verhindert stärkere pathologische Veränderungen.
- Nadeln mit Schlüssel FD576R austauschbar.
- Abstand zwischen den Nadeln variabel und mit Schlüssel FD576R fixierbar.



BIEMER

**FD635R**

Nerv approximator, complete  
with wrench FD576R

Nerv-Approximator, komplett  
mit Schlüssel FD576R

**FD636R**

1 pair of spare needles

1 Paar Ersatznadeln

# Micro Vascular Surgery – Mikro-Gefäßchirurgie

## Vessel Clips

## Gefäßclips



FD871R



FD875R



FD879R

### Vessel Clips / Gefäßclips

Art. No. Art. Nr.	FD870R	FD871R	FD872R	FD873R	FD874R	FD875R	FD876R	FD877R	FD878R	FD879R
Length Länge	8 mm	8 mm	11 mm	11 mm	16 mm	16 mm	24 mm	24 mm	35 mm	35 mm
	Artery / Arterie	Vein / Vene	Artery / Arterie	Vein / Vene	Artery / Arterie	Vein / Vene	Artery / Arterie	Vein / Vene	Artery / Arterie	Vein / Vene
Designation Bezeichnung	B-1		B-2		B-3		HD-S		RD-S	



FD881R



FD885R



FD889R

### Approximatoren / Approximators

Art. No. Art. Nr.	FD880R	FD881R	FD882R	FD883R	FD884R	FD885R	FD886R	FD887R	FD888R	FD889R
Length Länge	8 mm	8 mm	11 mm	11 mm	16 mm	16 mm	24 mm	24 mm	35 mm	35 mm
	Artery / Arterie	Vein / Vene	Artery / Arterie	Vein / Vene	Artery / Arterie	Vein / Vene	Artery / Arterie	Vein / Vene	Artery / Arterie	Vein / Vene
Designation Bezeichnung	ABB-11		ABB-22		ABB-33		HD-D		RD-D	



FD891R



FD895R

### Approximatoren / Approximators

Art. No. Art. Nr.	FD890R	FD891R	FD892R	FD893R	FD894R	FD895R
Length Länge	8 mm	8 mm	11 mm	11 mm	16 mm	16 mm
	Artery / Arterie	Vein / Vene	Artery / Arterie	Vein / Vene	Artery / Arterie	Vein / Vene
Designation Bezeichnung	ABB-1		ABB-2		ABB-3	

Micro Vascular  
Mikro-Gefäß

INCHES

## Micro Vascular Surgery – Mikro-Gefäßchirurgie

## Vessel Clips

## Gefäßclips

- The arterial clips have a slightly inwards curved jaw tip to prevent slipping, see Fig. 1.  
Die arteriellen Clips weisen eine leicht nach innen gebogene Maulform auf, um ein Abgleiten zu verhindern, siehe Abb. 1.
- The venous clips have a flat parallel closing jaw, see Fig. 2.  
Die venösen Clips haben eine flache Maulform und schließen parallel, siehe Abb. 2.

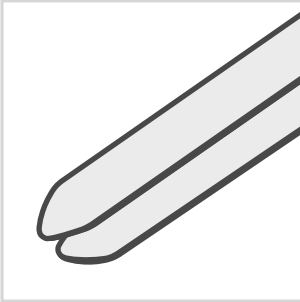

Fig. 1  
Abb. 1

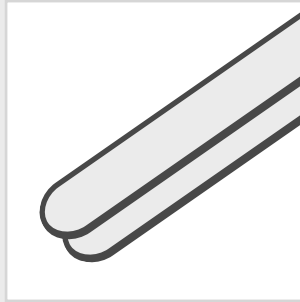

Fig. 2  
Abb. 2

Length Länge	8 mm	11 mm	16 mm	24 mm	35 mm
For vessel diameter Für Gefäß- durchmesser	0.3 - 1.0 mm	0.6 - 1.4 mm	1.0 - 2.2 mm	1.5 - 3.3 mm	2.0 - 5.0 mm



1/2

ACLAND

**FD896R-FD897R**

Applying forceps

Clip-Anlegepinzette

140 mm, 5 1/2"



**FD896R**

for 8-11 mm clips

für 8-11 mm Clips



1/1

**FD897R**

for 14-36 mm clips

für 14-36 mm Clips

## Micro Vascular Surgery – Mikro-Gefäßchirurgie

### Mini Vessel Clips and Approximators

### Mini Gefäßclips und Approximatoren

#### SCHWARTZ

Art. No. Art. Nr.		Length Länge	Jaw length Maullänge	Jaw width Maulbreite	Jaw type Maulform	Closing force Schließkraft
FD622R		25 mm, 1"	8 mm	2 mm	0°	4.0 N
FD623R		25 mm, 1"	8 mm	2 mm	25°	4.0 N
FD624R		25 mm, 1"	8 mm	2 mm	45°	4.0 N

Temporary vessel clips  
Temporäre Gefäßclips



#### SCHWARTZ

#### FD628R

Applying forceps  
for SCHWARTZ vessel clips

Anlegezange  
für Gefäßclips nach SCHWARTZ  
190 mm, 7 1/2"

Bone Instruments  
Knocheninstrumente



# Bone Instruments – Knocheninstrumente

## Elevators

### Elevatoren

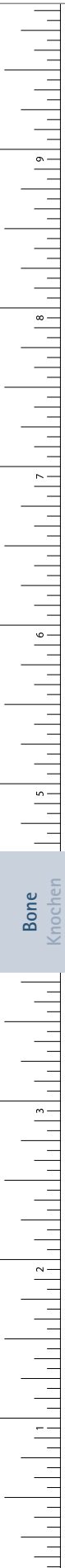

4.5 mm      4.5 mm

OM307R      OM308R

$\frac{1}{2}$

**KÖNIG**

**OM307R-OM308R**

155 mm, 6  $\frac{1}{8}$ "

5.5 mm

FK110R

$\frac{1}{2}$

**FK110R**

155 mm, 6  $\frac{1}{8}$ "

9 mm

FK141R

$\frac{1}{2}$

**CAIRNS**

**FK141R**

175 mm, 6  $\frac{7}{8}$ "

5 mm

FK120R

$\frac{1}{2}$

**WILLIGER**

**FK120R**

165 mm, 6  $\frac{1}{2}$ "

5.5 mm

FK121R

$\frac{1}{2}$

**WILLIGER**

**FK121R**

170 mm, 6  $\frac{3}{4}$ "

# Bone Instruments - Knocheninstrumente

## Elevators

### Elevatoren

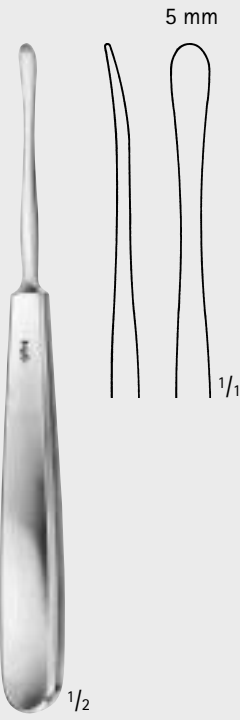

5 mm

1/1

1/2

**SEBILEAU**  
**FK124R**  
175 mm, 6 7/8"

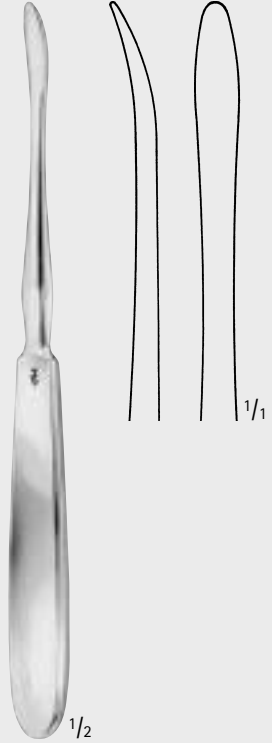

6 mm

1/1

1/2

**QUERVAIN**  
**FK133R**  
195 mm, 7 3/4"

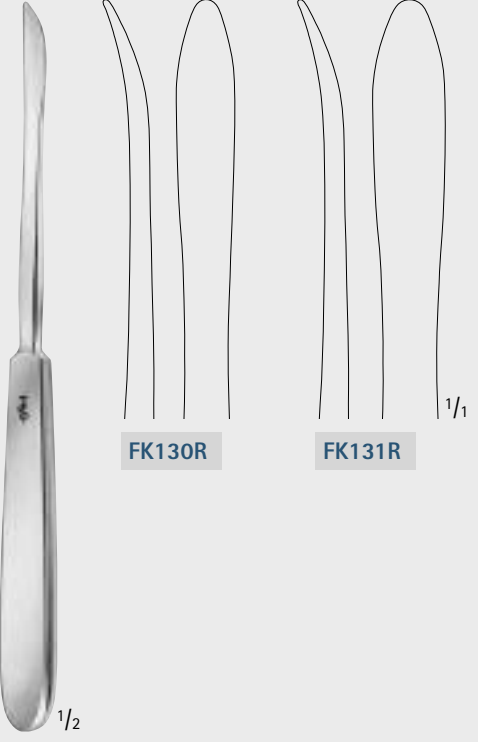

8 mm

10 mm

1/1

**FK130R**

**FK131R**

1/2

**LANGENBECK**  
**FK130R-FK131R**  
195 mm, 7 3/4"

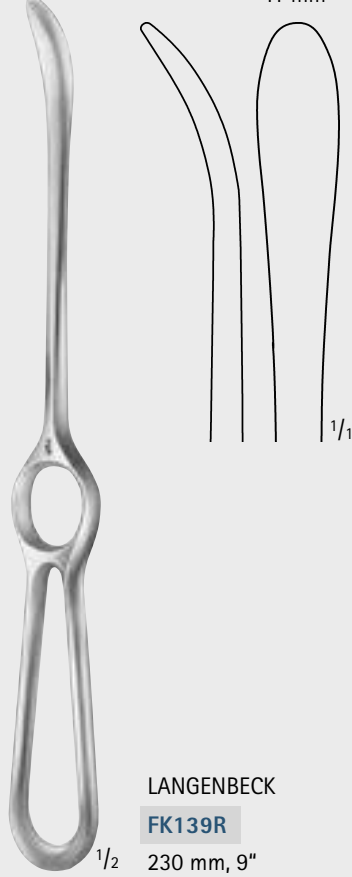

11 mm

1/1

1/2

**LANGENBECK**  
**FK139R**  
230 mm, 9"

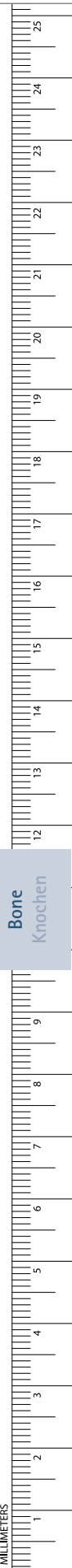

## Bone Instruments – Knocheninstrumente

### Elevators, Raspatories, Syndesmotomes

### Elevatoren, Raspatorien, Syndesmotome



3.3 mm

1/2

**HALLE**  
**OL160R**  
blunt  
stumpf  
180 mm, 7"

4 mm

1/2

**FREER**  
**OL163R**  
blunt  
stumpf  
190 mm, 7 1/2"

4 mm

1/2

**FREER**  
**OL162R**  
sharp  
scharf  
190 mm, 7 1/2"

5.9 mm

1/2

**SEWALL**  
**OL198R**  
sharp  
scharf  
200 mm, 7 7/8"



Bone  
Knochen

1/2

**CHOMPRET**  
**DO501R-DO503R**  
Syndesmotomes  
Syndesmotome  
150 mm, 6"



# Bone Instruments – Knocheninstrumente

## Elevators, Raspatories

## Elevatoren, Raspatorien

**PENNINGTON**  
**OL151R**  
 Raspatory  
 Raspatorium  
 210 mm, 8 1/4"

**COTTLE**  
**OL152R**  
 Elevator, graduated  
 Elevatorium mit Graduierung  
 200 mm, 7 7/8"

**MASING**  
**OL153R**  
 Elevator, graduated  
 Elevatorium mit Graduierung  
 200 mm, 7 7/8"

**OBWEGESER-FREER**  
**OL169R**  
 Elevator, blunt/sharp  
 Elevatorium, stumpf/scharf  
 210 mm, 8 1/4"

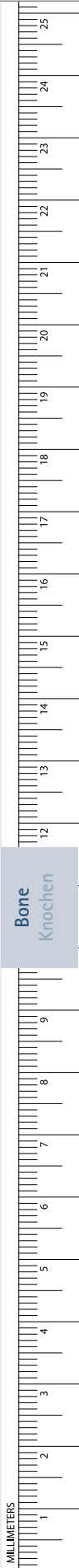

# Bone Instruments – Knocheninstrumente

## Raspatories

## Raspatorien



**HOWARTH**  
**OL171R**  
 sharp/blunt  
 scharf/stumpf  
 215 mm, 8 1/2"

1/2 1/1

**FREER**  
**OL159R**  
 sharp  
 scharf  
 175 mm, 6 7/8"

1/2 1/1



**COTTLE**  
**OL155R**  
 sharp/sharp  
 scharf/scharf  
 200 mm, 7 7/8"

1/2 1/1

**HILL**  
**OL179R**  
 blunt/semi-sharp  
 stumpf/halbscharf  
 220 mm, 8 3/4"

4 mm  
 5 mm

1/2 1/1

Bone  
Knochen

INCHES

# Bone Instruments - Knocheninstrumente

## Raspatories

## Raspatorien

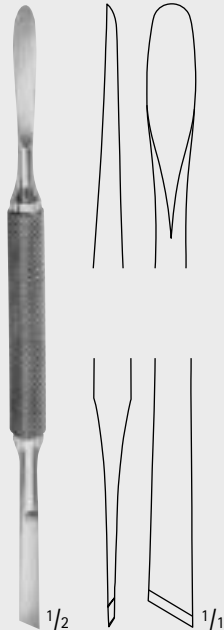

**MEAD**  
**DO520R**  
sharp/sharp  
scharf/scharf  
165 mm, 6 1/2"

1/2 1/1

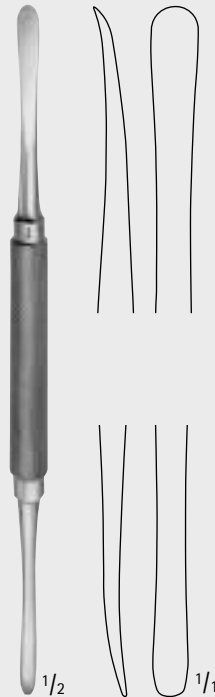

**MOLT**  
**DO543R**  
sharp/sharp  
scharf/scharf  
180 mm, 7"

1/2 1/1



4 mm

**SYME**  
**DO547R**  
sharp  
scharf  
185 mm, 7 1/4"

1/2 1/1

4 mm



**SELDIN**  
**DO552R**  
sharp/sharp  
scharf/scharf  
195 mm, 7 3/4"

1/2 1/1



**SELDIN**  
**DO553R**  
sharp/blunt  
scharf/stumpf  
195 mm, 7 3/4"

1/2 1/1

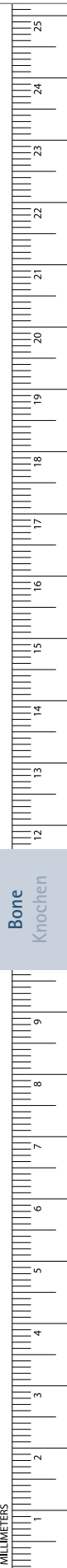

# Bone Instruments – Knocheninstrumente

## Raspatories

## Raspatorien



**KILLIAN**  
**OL170R**  
 blunt/sharp  
 stumpf/scharf  
 185 mm, 7 1/4"

**MAC DONALD**  
**FK291R**  
 blunt/blunt  
 stumpf/stumpf  
 185 mm, 7 1/4"

**WATSON-CHEYNE**  
**FK292R-FK293R**

2 mm      2 mm

2.5 mm      2.7 mm

**FK292R**      **FK293R**  
 blunt/blunt      blunt/blunt  
 stumpf/stumpf      stumpf/stumpf  
 130 mm, 5 1/8"      190 mm, 7 1/2"

**FREER**  
**OL164R**  
 sharp/blunt  
 scharf/stumpf  
 180 mm, 7"

4 mm

4.5 mm

**FREER**  
**OL165R**  
 blunt/sharp  
 stumpf/scharf  
 185 mm, 7 1/4"

4 mm

4 mm

**FREER**  
**OL154R**  
 blunt/sharp  
 stumpf/scharf  
 185 mm, 7 1/4"

4 mm

3.5 mm

**FREER-YASARGIL**  
**OL166R**  
 sharp/sharp  
 scharf/scharf  
 185 mm, 7 1/4"

3 mm

3 mm

Bone  
Knochen

# Bone Instruments – Knocheninstrumente

## Raspatories

## Raspatorien

**GLICKMAN**  
**DB850R**  
185 mm, 7 1/4"

**PRICHARD**  
**DB020R**  
delicate  
grazil  
185 mm, 7 1/4"

**LANGE**  
**DB022R**  
180 mm, 7"

**FREER**  
**DB025R**  
190 mm, 7 1/2"

**BUSER**  
**DX201R**  
185 mm, 7 1/4"

**MANNERFELT MODIF.**  
**FK530R-FK552R**  
155 mm, 6 1/8"

<b>FK530R</b> 4 mm	<b>FK532R</b> 7 mm	<b>FK534R</b> 9 mm	<b>FK541R</b> 3 mm	<b>FK543R</b> 6 mm	<b>FK552R</b> 8 mm
-----------------------	-----------------------	-----------------------	-----------------------	-----------------------	-----------------------

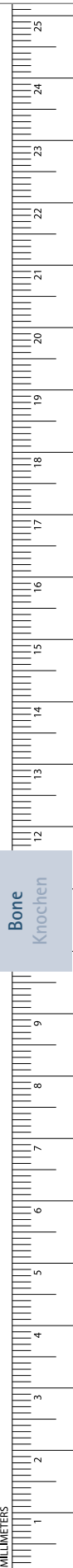

# Bone Instruments – Knocheninstrumente

## Raspatories

## Raspatorien

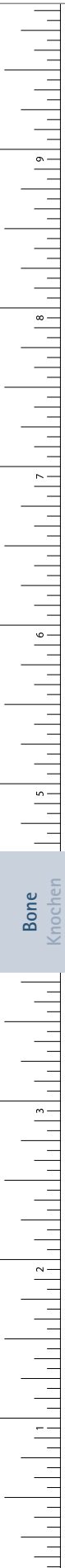

3.2 mm

1/2

1/1

**LEMPERT**  
**OG165R**  
semi-sharp  
halbscharf  
165 mm, 6 1/2"

6.3 mm

1/2

1/1

**LEMPERT**  
**OG164R**  
sharp  
scharf  
185 mm, 7 1/4"

5 mm

1/2

1/1

**ADSON**  
**FK299R**  
sharp  
scharf  
165 mm, 6 1/2"

4.6 mm

1/2

1/1

**PARTSCH**  
**DO612R**  
sharp  
scharf  
150 mm, 6"

4 mm

1/2

1/1

**PARTSCH MOD. LANGE**  
**DO642R**  
sharp  
scharf  
145 mm, 5 3/4"

4.5 mm

1/2

1/1

**MC KENTY**  
**OL192R**  
sharp  
scharf  
150 mm, 6"

5 mm

1/2

1/1

**KÖNIG**  
**OM309R**  
sharp  
scharf  
155 mm, 6 1/8"

# Bone Instruments - Knocheninstrumente

## Raspatories Raspatorien

8 mm

1/2

**TRELAT**  
**OM311R**  
150 mm, 6"

4 mm

4 mm

1/2

**OM314R** **OM315R**

**OM314R-OM315R**  
140 mm, 5 1/2"

4.2 mm

1/2

**WILLIGER**  
**DO510R**  
140 mm, 5 1/2"

6 mm

8 mm

1/2

**FK300R** **FK303R**

**WILLIGER**  
**FK300R-FK303R**  
160 mm, 6 1/4"

5.5 mm

1/2

**WARD**  
**DO546R**  
170 mm, 6 3/4"

4 mm

1/2

**JOSEPH**  
**FK310R**  
180 mm, 7"

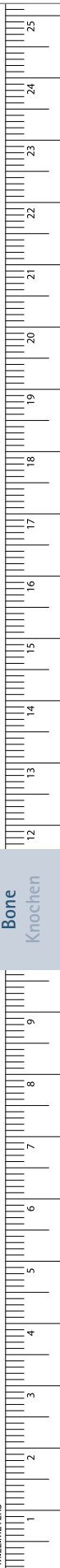

# Bone Instruments – Knocheninstrumente

## Raspatories

## Raspatorien



**FK319R**  
 curved, straight tip  
 gebogen, Spitze gerade  
 190 mm, 7 1/2"

**FK318R**  
 straight, straight tip  
 gerade, Spitze gerade  
 190 mm, 7 1/2"

**FK321R**  
 curved, round tip  
 gebogen, Spitze rund  
 190 mm, 7 1/2"

**FK362R**  
**JANSEN**  
 strongly curved  
 stark gebogen  
 165 mm, 6 1/2"

**FK301R-FK302R**  
 slightly curved  
 leicht gebogen  
 165 mm, 6 1/2"

**OL180R**  
**PLESTER**  
 straight  
 gerade  
 180 mm, 7"



# Bone Instruments - Knocheninstrumente

## Raspatories

## Raspatorien

4 mm

1/1

1/2

**MÜHLING**  
**FK394R**  
sharp  
scharf  
165 mm, 6 1/2"

8 mm

1/1

1/2

**COTTLE**  
**OL157R**  
sharp  
scharf  
195 mm, 7 3/4"

14 mm

1/1

1/2

**JANSEN**  
**OL161R**  
Raspatory, sharp  
Raspatorium, scharf  
195 mm, 7 3/4"

4.7 mm

1/1

1/2

**LANDOLT**  
**FK314R**  
sharp  
scharf  
175 mm, 6 7/8"

6.2 mm

1/1

1/2

**CASPAR**  
**FK328R**  
sharp  
scharf  
180 mm, 7"

6.2 mm

1/1

1/2

**CASPAR**  
**FK329R**  
semi-sharp  
halbscharf  
180 mm, 7"

6 mm

1/1

1/2

**DO523R**  
sharp  
scharf  
170 mm, 6 3/4"

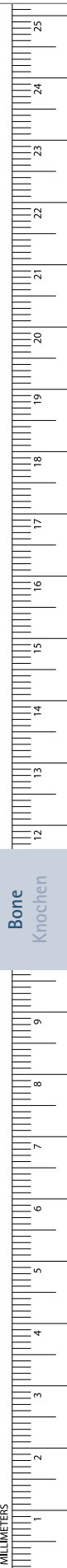

# Bone Instruments – Knocheninstrumente

## Raspatories

## Raspatorien



6 mm

7 mm

9 mm

11 mm

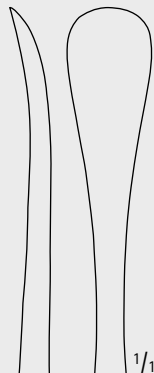

OL140R

OL141R

OL142R

OL143R

1/2

OBWEGESER

OL140R-OL143R

sharp

scharf

180 mm, 7"

8 mm

7 mm

7 mm

7 mm

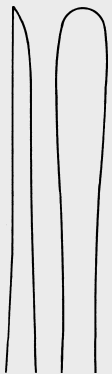

FK306R

FK308R

FK307R

FK309R

1/2

ADSON

FK306R-FK309R

170 mm, 6 3/4"

9.5 mm

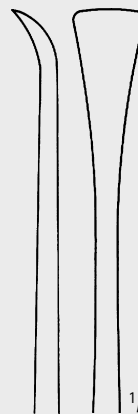

1/2

BÜCHS

DO518R

190 mm, 7 1/2"

Bone  
Knochen

INCHES

# Bone Instruments – Knocheninstrumente

## Raspatories

## Raspatorien

17 mm

$\frac{1}{2}$

**LANGENBECK**  
**MB279R**

sharp  
scharf  
190 mm, 7  $\frac{1}{2}$ "

12.5 mm

$\frac{1}{2}$

**FARABEUF**  
**FK340R**

sharp  
scharf  
145 mm, 5  $\frac{3}{4}$ "

12.5 mm

$\frac{1}{2}$

**FARABEUF**  
**FK341R**

sharp  
scharf  
145 mm, 5  $\frac{3}{4}$ "

11 mm

$\frac{1}{2}$

**FARABEUF-COLLIN**  
**FK344R**

sharp  
scharf  
160 mm, 6  $\frac{1}{4}$ "

11 mm

$\frac{1}{2}$

**FARABEUF-COLLIN**  
**FK345R**

sharp  
scharf  
160 mm, 6  $\frac{1}{4}$ "

18 mm

$\frac{1}{2}$

**SEDILLOT**  
**FK350R**

sharp  
scharf  
185 mm, 7  $\frac{1}{4}$ "

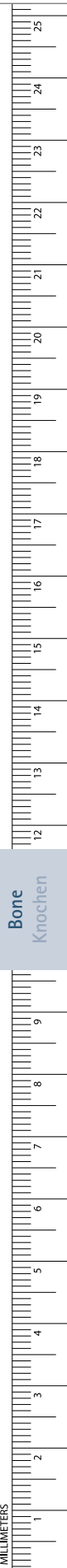

# Bone Instruments – Knocheninstrumente

## Raspatories

## Raspatorien

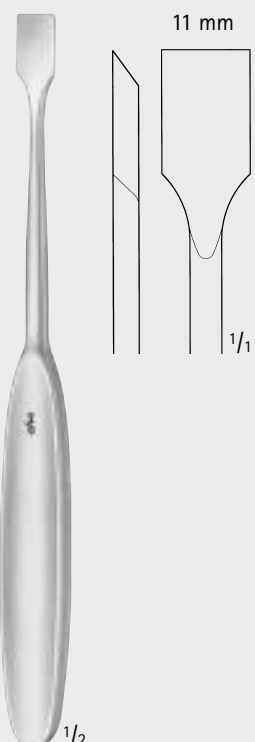

11 mm

1/2

**MC KISSOCK**  
**FK379R**  
sharp  
scharf  
195 mm, 7 3/4"

Detailed description: This panel shows the MC KISSOCK raspatory. It features a long, slender handle with a textured grip. The head is a flat, rectangular blade with a width of 11 mm. Technical drawings show the blade's profile and a cross-section with a 1/1 ratio. The instrument is shown in a perspective view with a 1/2 scale marker.

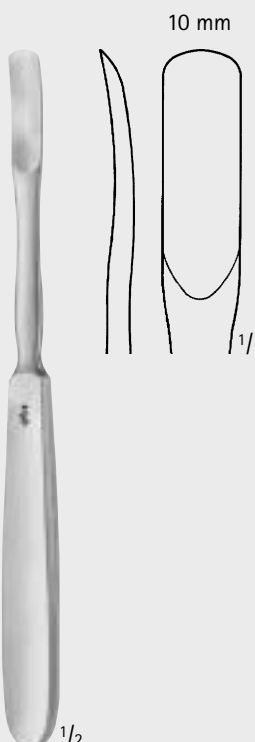

10 mm

1/2

**KRÄMER**  
**FK390R**  
sharp  
scharf  
185 mm, 7 1/4"

Detailed description: This panel shows the KRÄMER raspatory. It has a long handle and a blade that is 10 mm wide. The blade has a slightly curved, rounded tip. Technical drawings show the blade's profile and a cross-section with a 1/1 ratio. The instrument is shown in a perspective view with a 1/2 scale marker.

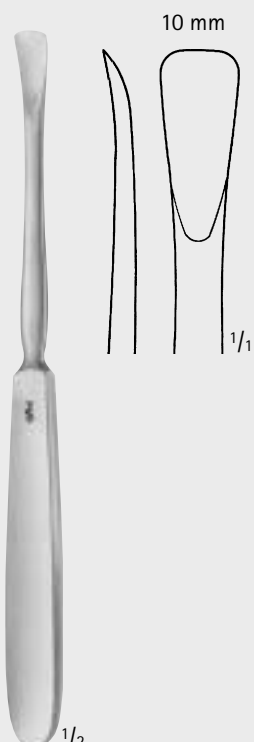

10 mm

1/2

**KRÄMER**  
**FK391R**  
sharp  
scharf  
190 mm, 7 1/2"

Detailed description: This panel shows another KRÄMER raspatory. It has a long handle and a blade that is 10 mm wide. The blade has a distinct V-shaped notch at the tip. Technical drawings show the blade's profile and a cross-section with a 1/1 ratio. The instrument is shown in a perspective view with a 1/2 scale marker.

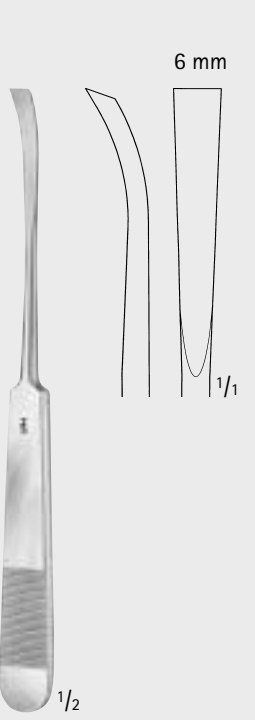

6 mm

1/2

**PENNYBACKER**  
**FK378R**  
sharp  
scharf  
165 mm, 6 1/2"

Detailed description: This panel shows the PENNYBACKER raspatory. It has a long handle with a textured grip and a blade that is 6 mm wide. The blade has a curved, hook-like shape. Technical drawings show the blade's profile and a cross-section with a 1/1 ratio. The instrument is shown in a perspective view with a 1/2 scale marker.

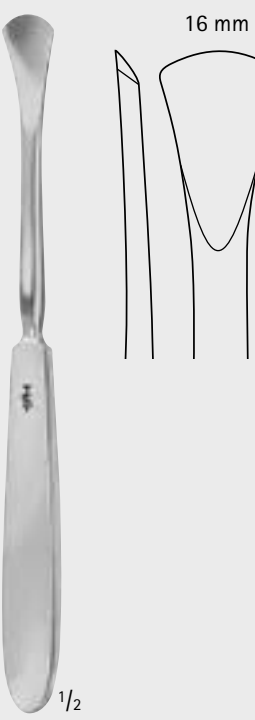

16 mm

1/2

**LANGENBECK**  
**FK360R**  
sharp  
scharf  
190 mm, 7 1/2"

Detailed description: This panel shows the LANGENBECK raspatory. It has a long handle and a wide blade that is 16 mm across. The blade has a curved, hook-like shape. Technical drawings show the blade's profile and a cross-section with a 1/1 ratio. The instrument is shown in a perspective view with a 1/2 scale marker.

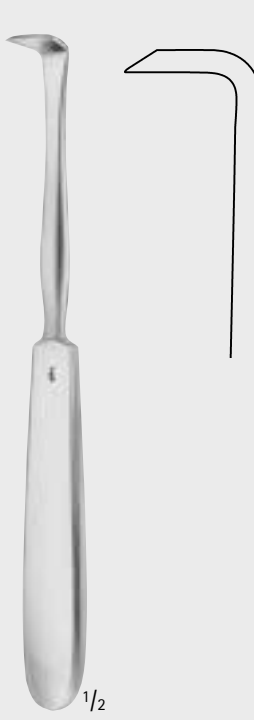

14 mm

1/2

**LANGENBECK**  
**FK361R**  
sharp  
scharf  
180 mm, 7"

Detailed description: This panel shows another LANGENBECK raspatory. It has a long handle and a wide blade that is 14 mm across. The blade has a curved, hook-like shape. Technical drawings show the blade's profile and a cross-section with a 1/1 ratio. The instrument is shown in a perspective view with a 1/2 scale marker.

# Bone Instruments - Knocheninstrumente

## Raspatories

## Raspatorien



DOYEN

**FK400R-FK401R**

for children

für Kinder

175 mm, 6 7/8"

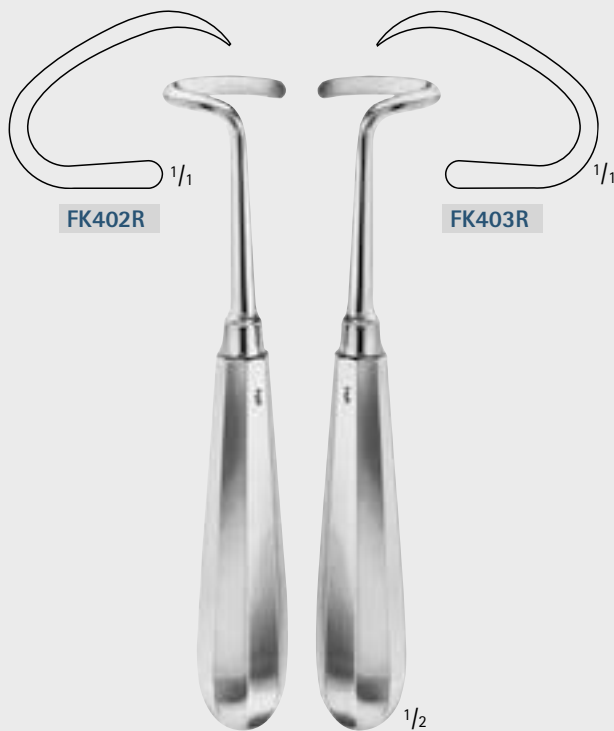

DOYEN

**FK402R-FK403R**

for adults

für Erwachsene

175 mm, 6 7/8"

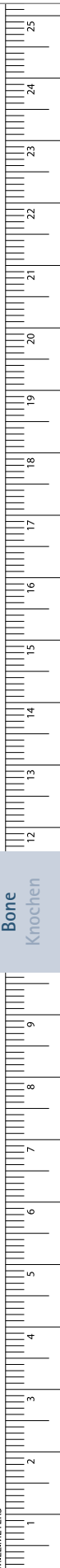

# Bone Instruments – Knocheninstrumente

## Bone Curettes

### Scharfe Löffel

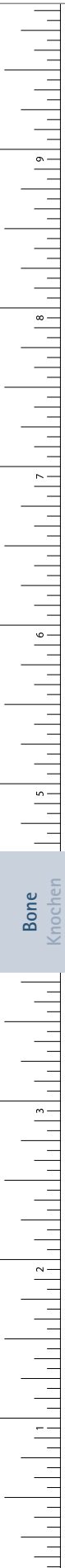

JACOBSON  
**FK813R**  
140 mm, 5 1/2"

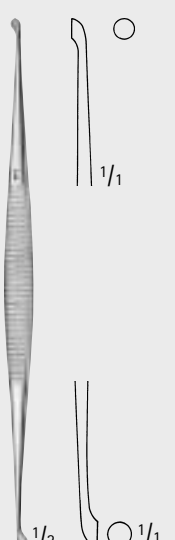

MARTINI  
**FK800R**  
140 mm, 5 1/2"

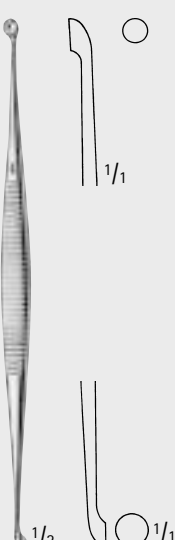

MARTINI  
**FK801R**  
140 mm, 5 1/2"



WILLIGER  
**FK814R**  
145 mm, 5 3/4"



JANZEN  
**FK803R**  
160 mm, 6 1/4"



BARTH  
**FK817R**  
180 mm, 7"



**FK850R**  
210 mm, 8 1/4"



MILLER  
**DO606R**  
180 mm, 7"

Bone  
Knochen

# Bone Instruments – Knocheninstrumente

## Bone Curettes

### Scharfe Löffel

2.8 x 3.2 mm

HOUSE 2.6 x 3.5 mm

**OG178R**  
 oval cups  
 oval  
 150 mm, 6"

2.2 x 3.8 mm

HOUSE 2.8 x 4.8 mm

**OG179R**  
 oval cups, extra large  
 oval, extra groß  
 150 mm, 6"

0.6 x 0.8 mm

HOUSE 0.8 x 1.0 mm

**OG186R**  
 oval cups, angled  
 oval, kniegebogen  
 150 mm, 6"

1.5 x 2.5 mm

SHEA 1/2

**OG180R**  
 oval cups  
 oval  
 160 mm, 6 1/4"

HOUSE 1/2

Art. No.	Tip
Art. Nr.	Arbeitsende
<b>OG181R</b>	Diam. 1.0 + 1.2 mm Ø 1,0 + 1,2 mm
<b>OG182R</b>	Diam. 1.5 + 1.8 mm Ø 1,5 + 1,8 mm

oval cups  
 oval  
 150 mm, 6"

HOUSE 1/2

Art. No.	Tip
Art. Nr.	Arbeitsende
<b>OG184R</b>	Diam. 1.0 + 1.2 mm Ø 1,0 + 1,2 mm
<b>OG185R</b>	Diam. 1.5 + 1.8 mm Ø 1,5 + 1,8 mm

oval cups, strongly angled  
 oval, stark abgewinkelt  
 150 mm, 6"

HOUSE 1/2

**OG189R**  
 angled cups  
 pointed, large  
 abgebogen  
 spitz, groß  
 170 mm, 6 3/4"

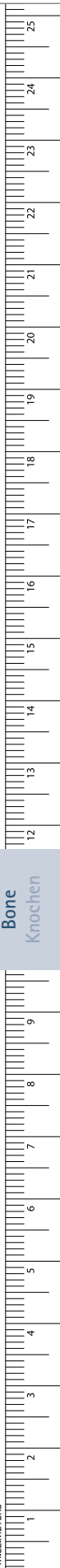

# Bone Instruments – Knocheninstrumente

## Bone Curettes

### Scharfe Löffel



**DO650R**  
160 mm, 6 1/4"

**JANSEN**  
**DO651R**  
160 mm, 6 1/4"

**HEMINGWAY**  
**DO655R**  
170 mm, 6 3/4"

**Bone**  
**Knochen**

**HEMINGWAY**  
**DO656R**  
170 mm, 6 3/4"

**HEMINGWAY**  
**DO670R**  
Fig. 0  
170 mm, 6 3/4"

■ ERGOPLANT

**LUCAS**  
**DX220R**  
190 mm, 7 1/2"



# Bone Instruments – Knocheninstrumente

## Bone Curettes

### Scharfe Löffel

HEMINGWAY  
**DO671R**  
 Fig. 1  
 170 mm, 6 3/4"

HEMINGWAY  
**DO672R**  
 Fig. 2  
 170 mm, 6 3/4"

HEMINGWAY  
**DO673R**  
 Fig. 3  
 170 mm, 6 3/4"

HEMINGWAY  
**DO674R**  
 Fig. 4  
 170 mm, 6 3/4"

LUCAS  
**DO608R**  
 180 mm, 7"

LUCAS  
**DO609R**  
 185 mm, 7 1/4"

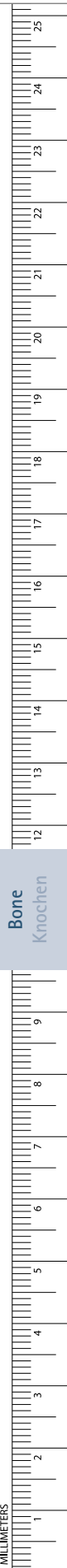

# Bone Instruments – Knocheninstrumente

## Endaural Curettes

### Scharfe Löffel

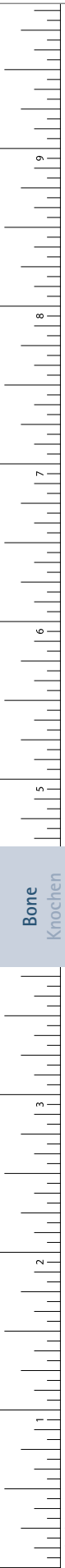

**UFFENORDE**  
**FK660R**  
 170 mm, 6 3/4"

**UFFENORDE**  
**FK661R**  
 170 mm, 6 3/4"

**BRUNS**  
**FK611R-FK617R**  
 165 mm, 6 1/2"

3 mm Fig. 000 <b>FK611R</b>	4 mm Fig. 00 <b>FK612R</b>	5 mm Fig. 0 <b>FK613R</b>	6 mm Fig. 1 <b>FK614R</b>
8 mm Fig. 2 <b>FK615R</b>	10 mm Fig. 3 <b>FK616R</b>	12 mm Fig. 4 <b>FK617R</b>	

**SCHEDE**  
**FK621R-FK627R**  
 170 mm, 6 3/4"

2.5 mm Fig. 000 <b>FK621R</b>	3.4 mm Fig. 00 <b>FK622R</b>	4.2 mm Fig. 0 <b>FK623R</b>	5.2 mm Fig. 1 <b>FK624R</b>
6.3 mm Fig. 2 <b>FK625R</b>	7.4 mm Fig. 3 <b>FK626R</b>	8 mm Fig. 4 <b>FK627R</b>	

# Bone Instruments – Knocheninstrumente

## Endaural Curettes

### Scharfe Löffel



2.8 mm    3.6 mm    4.4 mm    5.2 mm    6.8 mm    8.5 mm

Fig. 0000    Fig. 000    Fig. 00    Fig. 0    Fig. 1    Fig. 2

**FK630R**    **FK631R**    **FK632R**    **FK633R**    **FK634R**    **FK635R**

10 mm    11.5 mm    13 mm    14.5 mm

Fig. 3    Fig. 4    Fig. 5    Fig. 6

**FK636R**    **FK637R**    **FK638R**    **FK639R**

**VOLKMANN**  
**FK630R–FK639R**  
170 mm, 6 3/4"



3.4 mm    5.2 mm

Fig. 00    Fig. 1

**FK658R**    **FK659R**

**WILLIGER**  
**FK658R–FK659R**  
170 mm, 6 3/4"



1.8 mm    2.0 mm    2.4 mm    2.6 mm    2.8 mm

**FK675R**    **FK676R**    **FK677R**    **FK678R**    **FK679R**

**LEMPERT**  
**FK675R–FK679R**  
215 mm, 8 1/2"

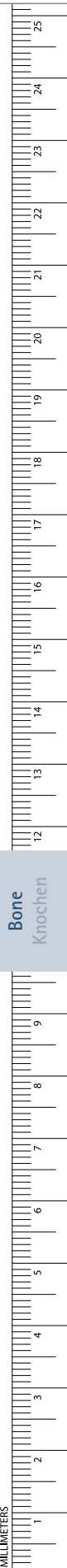

# Bone Instruments – Knocheninstrumente

## Endaural Curettes

### Scharfe Löffel



malleable  
biegsam

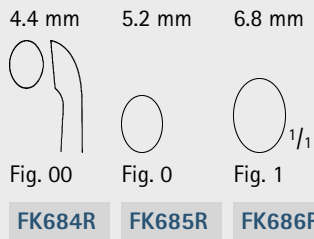

HALLE

**FK684R-FK686R**

215 mm, 8 1/2"

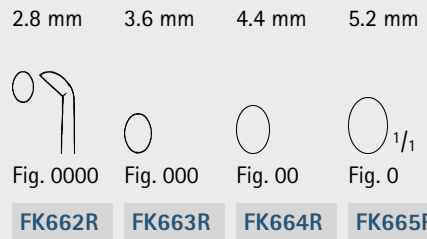

DAUBENSPECK

**FK662R-FK665R**

200 mm, 7 7/8"

## Bone Instruments – Knocheninstrumente

### Chisels, Gouges, Osteotomes

#### Flach- und Hohlmeißel, Osteotome



1/2

**FREER**

Art. No.	Tip (mm)
Art. Nr.	Arbeitsende (mm)
<b>OL311R</b>	4.0

Chisel  
Flachmeißel  
160 mm, 6 1/4"



1/2

**FREER**

Art. No.	Tip (mm)
Art. Nr.	Arbeitsende (mm)
<b>OL314R</b>	4.0

Chisel, curved  
Flachmeißel, gebogen  
160 mm, 6 1/4"



1/2

**FREER**

Art. No.	Tip (mm)
Art. Nr.	Arbeitsende (mm)
<b>OL316R</b>	6.0

Gauge  
Hohlmeißel  
150 mm, 6"



1/2

**MANNERFELT MODIF.**

Art. No.	Tip (mm)
Art. Nr.	Arbeitsende (mm)
<b>FL144R</b>	4
<b>FL146R</b>	6
<b>FL148R</b>	8

Osteotomes  
Osteotome  
155 mm, 6 1/8"



1/2

**MANNERFELT MODIF.**

Art. No.	Tip (mm)
Art. Nr.	Arbeitsende (mm)
<b>FL153R</b>	3

Gauge  
Hohlmeißel  
150 mm, 6"



6 mm

1/2

**BALLENGER**

**OL318R**

Septum gauge with notch, straight  
Septum-Hohlmeißel mit Kerbe, gerade  
150 mm, 6"

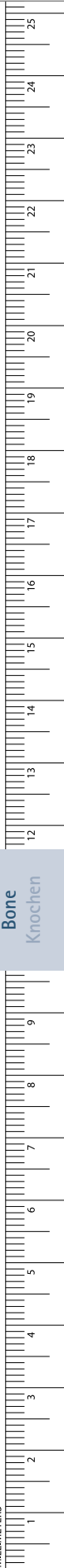

# Bone Instruments – Knocheninstrumente

## Osteotomes

### Osteotome

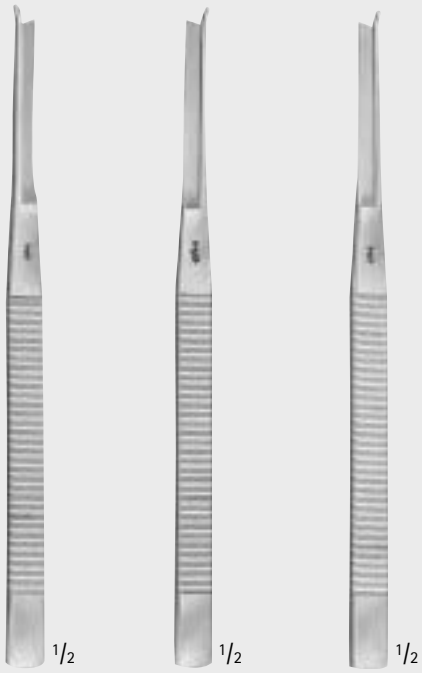
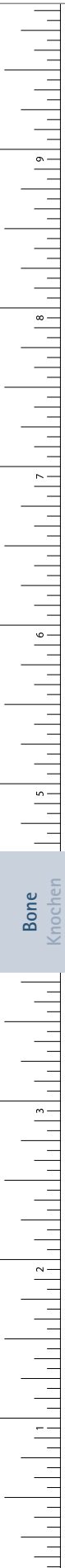

**OL321R** OL322R OL323R  
 curved left links gebogen curved right rechts gebogen straight gerade

MASING

**OL321R-OL323R**

single guarded mit einseitig verrundeter Ecke  
 175 mm, 6 7/8"

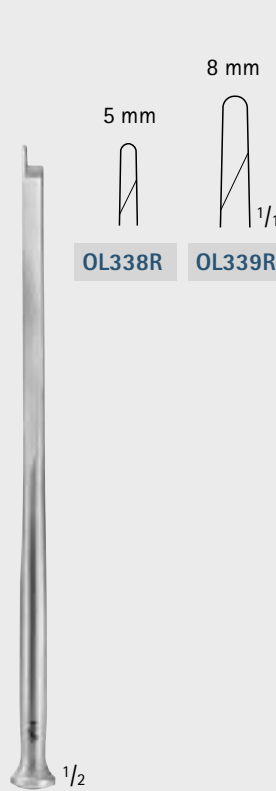

FOMON

**OL338R-OL339R**

single guarded mit einseitig verrundeter Ecke  
 170 mm, 6 3/4"

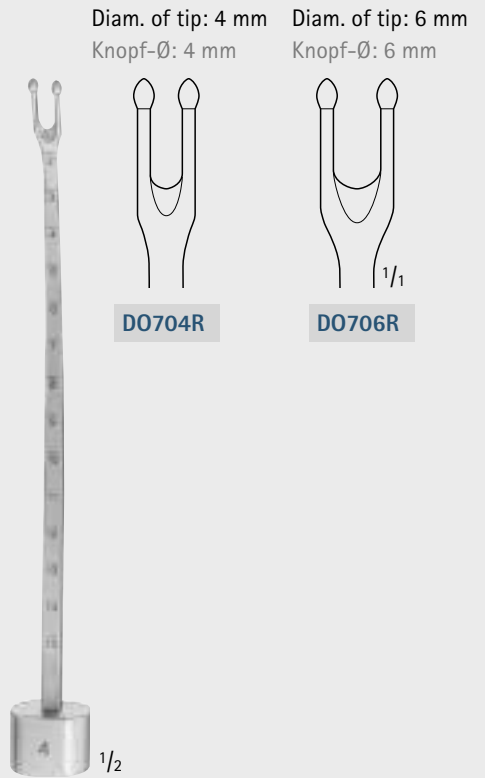

**D0704R-D0706R**

for septum Nasenseptum-Osteotome  
 185 mm, 7 1/4"



CINELLI

**OL326R-OL329R**

double guarded mit einseitig verrundeten Ecken  
 160 mm, 6 1/4"

## Bone Instruments – Knocheninstrumente

### Chisels, Gouges, Osteotomes

#### Flach- und Hohlmeißel, Osteotome

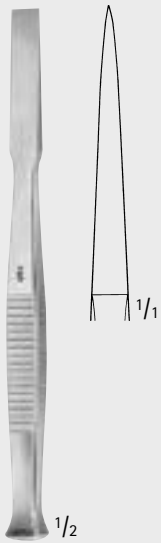

Art. No. Art. Nr.	Tip size Arbeitsende (mm)
----------------------	---------------------------------

FL110R	4
FL112R	6
FL114R	8
FL116R	10
FL118R	12
Osteotome	
Osteotom	
140 mm, 5 1/2"	

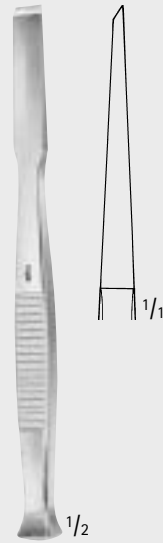

Art. No. Art. Nr.	Tip size Arbeitsende (mm)
----------------------	---------------------------------

FL120R	4
FL122R	6
FL124R	8
FL126R	10
FL128R	12
Chisel	
Flachmeißel	
140 mm, 5 1/2"	



GILLIES

Art. No. Art. Nr.	Tip size Arbeitsende (mm)
----------------------	---------------------------------

OL341R	5
OL342R	7
OL343R	9
Osteotome	
Osteotom	
140 mm, 5 1/2"	

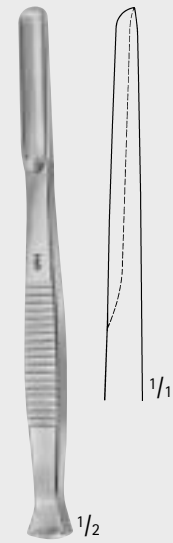

Art. No. Art. Nr.	Tip size Arbeitsende (mm)
----------------------	---------------------------------

FL130R	4
FL132R	6
FL134R	8
FL136R	10
FL138R	12
Gauge	
Hohlmeißel	
140 mm, 5 1/2"	

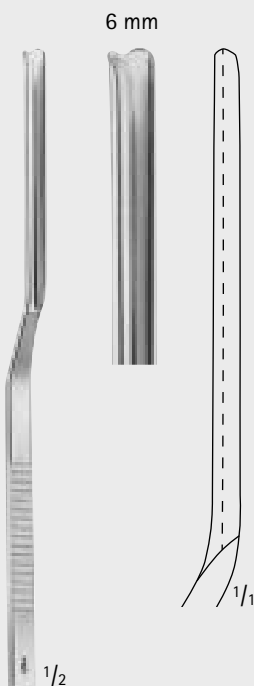

KILLIAN-CLAUS

**OL335R**

Septum gauge, with notch,  
bayonet-shaped  
Septum-Hohlmeißel, mit Kerbe,  
bajonettförmig gebogen  
170 mm, 6 3/4"



KILLIAN

**OL336R**

Septum gauge, round cutting edge,  
bayonet-shaped  
Septum-Hohlmeißel, mit runder Schneide,  
bajonettförmig gebogen  
170 mm, 6 3/4"

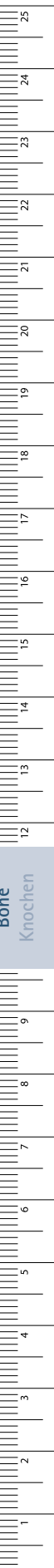

Bone  
Knochen

MILLIMETERS

# Bone Instruments – Knocheninstrumente

## Chisels, Gouges, Osteotomes

### Flach- und Hohlmeißel, Osteotome



**PARTSCH**

Art. No. Art. Nr.	Tip size Arbeitsende (mm)
FL173R	3
FL174R	4
FL175R	5
FL176R	6

Chisel  
Flachmeißel  
140 mm, 5 1/2"

**PARTSCH**

Art. No. Art. Nr.	Tip size Arbeitsende (mm)
FL183R	3
FL184R	4
FL185R	5
FL186R	6
FL187R	7

Chisel  
Flachmeißel  
170 mm, 6 3/4"

**PARTSCH**

Art. No. Art. Nr.	Tip size Arbeitsende (mm)
FL213R	3
FL214R	4
FL215R	5
FL216R	6

Gauge  
Hohlmeißel  
140 mm, 5 1/2"

**PARTSCH**

Art. No. Art. Nr.	Tip size Arbeitsende (mm)
FL223R	3
FL224R	4
FL225R	5
FL226R	6
FL227R	7

Gauge  
Hohlmeißel  
170 mm, 6 3/4"

**TESSIER**

Art. No. Art. Nr.	Tip size Arbeitsende (mm)
OL360R	2.5
OL361R	3.5
OL362R	5.0
OL366R	7.0
OL368R	10.0
OL370R	14.0
OL371R	18.0

Osteotome, straight  
Osteotom, gerade  
160 mm, 6 1/4"

**TESSIER**

Art. No. Art. Nr.	Tip size Arbeitsende (mm)
OL363R	5
OL367R	7
OL369R	10

Osteotome, curved  
Osteotom, gebogen  
160 mm, 6 1/4"

Bone  
Knochen



## Bone Instruments - Knocheninstrumente

### Chisels, Gouges, Osteotomes

### Flach- und Hohlmeißel, Osteotome

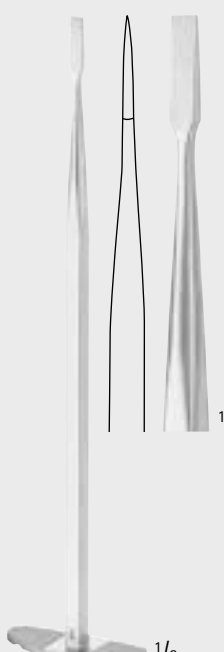

4 mm

1/1

1/2

**DAUTREY**  
**OL344R**  
Osteotome  
Osteotom  
170 mm, 6 3/4"

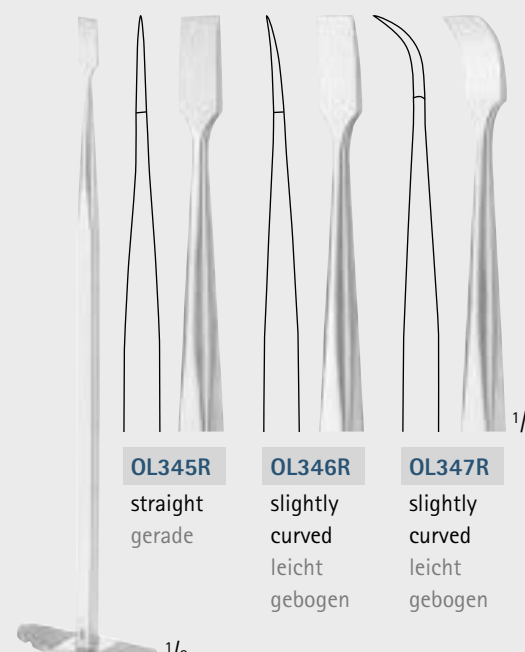

6 mm    6 mm    6 mm

1/1    1/1    1/1

1/2

<b>OL345R</b> straight gerade	<b>OL346R</b> slightly curved leicht gebogen	<b>OL347R</b> slightly curved leicht gebogen
-------------------------------------	--	--

**DAUTREY**  
**OL345R-OL347R**  
Osteotomes  
Osteotome  
170 mm, 6 3/4"

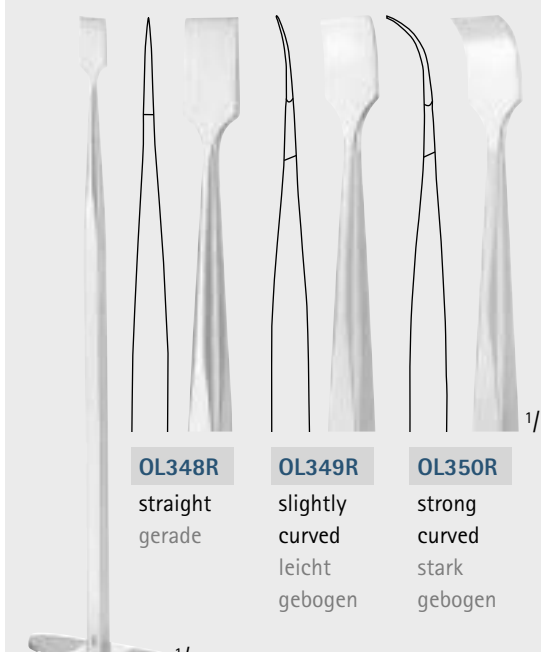

8 mm    8 mm    8 mm

1/1    1/1    1/1

1/2

<b>OL348R</b> straight gerade	<b>OL349R</b> slightly curved leicht gebogen	<b>OL350R</b> strong curved stark gebogen
-------------------------------------	--	---

**DAUTREY**  
**OL348R-OL350R**  
Osteotomes  
Osteotome  
170 mm, 6 3/4"



1/1

1/2

<b>LUCAS</b>	
<b>Art. No.</b> Art. Nr.	<b>Tip size</b> Arbeitsende (mm)
<b>DO711R</b>	4

Chisel  
Flachmeißel  
160 mm, 6 1/4"



1/1

1/2

<b>LUCAS</b>	
<b>Art. No.</b> Art. Nr.	<b>Tip size</b> Arbeitsende (mm)
<b>DO715R</b>	3

Gauge  
Hohlmeißel  
160 mm, 6 1/4"

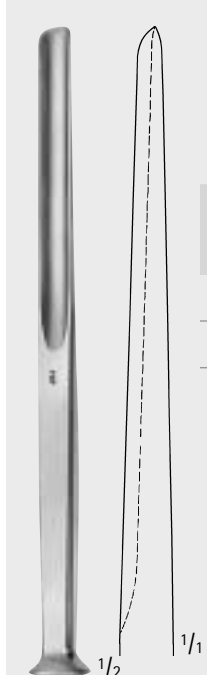

1/1

1/2

<b>ALEXANDER</b>	
<b>Art. No.</b> Art. Nr.	<b>Tip size</b> Arbeitsende (mm)
<b>FL343R</b>	7
<b>FL345R</b>	9
<b>FL347R</b>	11

Gauge  
Hohlmeißel  
170 mm, 6 3/4"

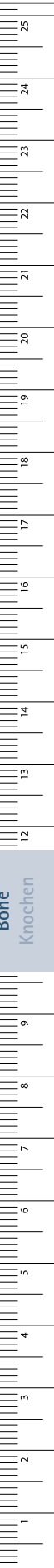

# Bone Instruments – Knocheninstrumente

## Osteotomes

### Osteotome



**LAMBOTTE**

Art. No. Art. Nr.	Tip size Arbeitsende (mm)
<b>FL088R</b>	2
<b>FL089R</b>	3
<b>FL101R</b>	4
<b>FL102R</b>	6
<b>FL104R</b>	8
<b>FL106R</b>	10
<b>FL108R</b>	12
<b>FL109R</b>	15

Osteotome  
Osteotom  
125 mm, 5"

**COTTLE**

Art. No. Art. Nr.	Tip size Arbeitsende (mm)
<b>OL294R</b>	4
<b>OL296R</b>	6
<b>OL298R</b>	8
<b>OL299R</b>	10
<b>OL300R</b>	12

Osteotome with depth markings  
Osteotom mit Graduierung  
180 mm, 7"



**COTTLE**

Art. No. Art. Nr.	Tip size Arbeitsende (mm)
<b>OL301R</b>	4
<b>OL302R</b>	7
<b>OL303R</b>	9
<b>OL304R</b>	12

Chisel-Osteotome with depth markings  
Osteotom mit einseitigem Anschlag  
und Graduierung  
180 mm, 7"

**COTTLE**

Art. No. Art. Nr.	Tip size Arbeitsende (mm)
<b>OL270R</b>	2
<b>OL271R</b>	4
<b>OL272R</b>	6
<b>OL273R</b>	7
<b>OL274R</b>	9
<b>OL275R</b>	12

Osteotome with depth markings  
and handle, straight  
Osteotom mit Graduierung  
und Griffbalken, gerade  
180 mm, 7"

# Bone Instruments – Knocheninstrumente

## Chisels, Osteotomes

### Flachmeißel, Osteotome



6 mm  
1/1  
1/2

**COTTLE**  
**OL305R**  
Osteotome with depth markings  
Osteotom mit Graduierung  
180 mm, 7"

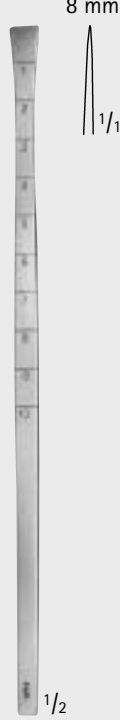

8 mm  
1/1  
1/2

**COTTLE**  
**OL307R**  
Fish-tail osteotom with protected ends  
Fischschwanzosteotom  
180 mm, 7"



3 mm 4.5 mm  
1/1  
1/2

**WALTER**  
**OL319R-OL320R**  
Chisels with notch, double graduated  
Flachmeißel mit Hohlkehle, Spitzen verrundet  
180 mm, 7"



2 mm 3 mm 4 mm 7 mm 9 mm  
1/1  
1/2

**WALTER**  
**OL390R-OL394R**  
Osteotomes  
Osteotome  
190 mm, 7 1/2"

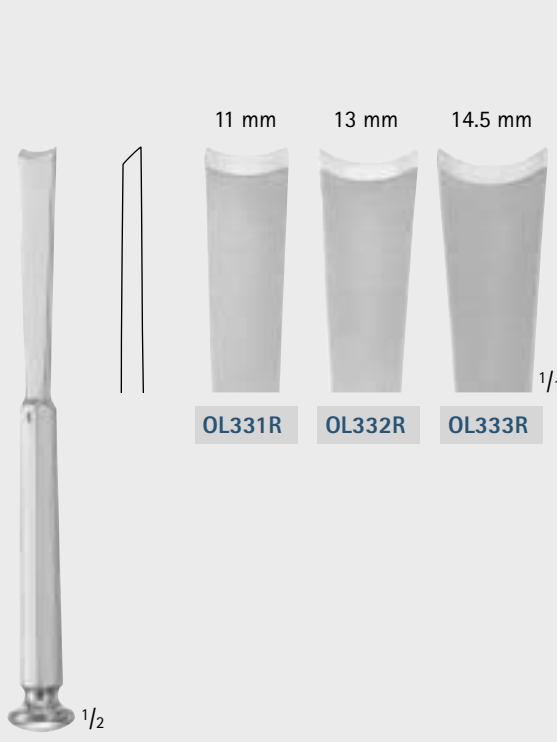

11 mm 13 mm 14.5 mm  
1/1  
1/2

**MC INDOE**  
**OL331R-OL333R**  
Chisels with notch, double guarded  
Meißel mit Hohlkehle, Spitzen verrundet  
155 mm, 6 1/8"

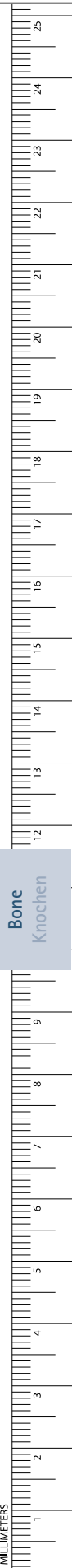

# Bone Instruments – Knocheninstrumente

## Chisels, Osteotomes

### Flachmeißel, Osteotome



Bone  
Knochen



EAST GRINSTEAD (WARD)

Art. No. Art. Nr.	Tip size Arbeitsende (mm)
<b>D0722R</b>	3
<b>D0723R</b>	5

Chisels  
Flachmeißel  
180 mm, 7"



EAST GRINSTEAD (WARD)

Art. No. Art. Nr.	Tip size Arbeitsende (mm)
<b>D0732R</b>	3
<b>D0733R</b>	5

Osteotome  
Osteotom  
180 mm, 7"



LAMBOTTE

Art. No. Art. Nr.	Tip size Arbeitsende (mm)
<b>FL650R</b>	4
<b>FL651R</b>	8
<b>FL652R</b>	10
<b>FL653R</b>	13
<b>FL654R</b>	15
<b>FL655R</b>	18
<b>FL656R</b>	20
<b>FL658R</b>	25
<b>FL659R</b>	30
<b>FL660R</b>	38
<b>FL661R</b>	44
<b>FL662R</b>	50

Osteotomes  
Osteotome  
245 mm, 9 5/8"



STILLE

Art. No. Art. Nr.	Tip size Arbeitsende (mm)
<b>FL503R</b>	10
<b>FL504R</b>	12
<b>FL505R</b>	15
<b>FL506R</b>	20
<b>FL507R</b>	25

Chisel  
Flachmeißel  
205 mm, 8"

# Bone Instruments – Knocheninstrumente

## Gouges, Osteotomes

### Hohlmeißel, Osteotome

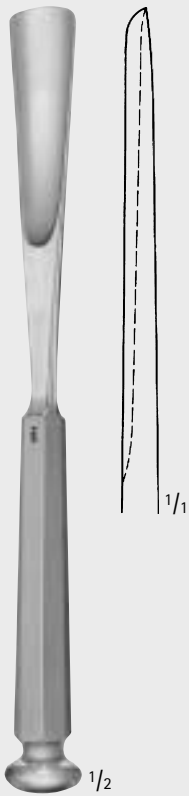

STILLE

Art. No. Art. Nr.	Tip size Arbeitsende (mm)
----------------------	---------------------------------

<b>FL573R</b>	10
<b>FL574R</b>	12
<b>FL575R</b>	15
<b>FL576R</b>	20
<b>FL577R</b>	25

Gauge  
Hohlmeißel  
205 mm, 8"

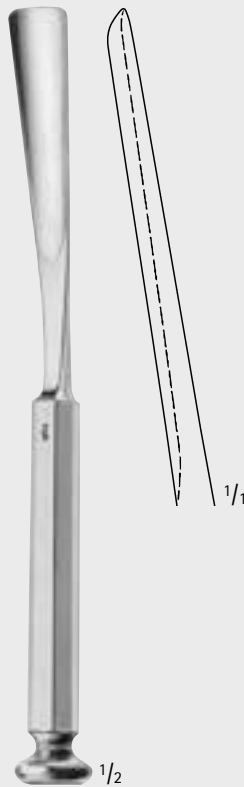

WALTER

Art. No. Art. Nr.	Tip size Arbeitsende (mm)
----------------------	---------------------------------

<b>FL583R</b>	10
<b>FL585R</b>	15

Gouges for taking grafts  
from the ribs  
Hohlmeißel zur Knorpel-  
entnahme aus der Rippe  
205 mm, 8"



STILLE

Art. No. Art. Nr.	Tip size Arbeitsende (mm)
----------------------	---------------------------------

<b>FL512R</b>	8
<b>FL513R</b>	10
<b>FL514R</b>	12
<b>FL515R</b>	15
<b>FL516R</b>	20
<b>FL517R</b>	25

Osteotomes  
Osteotome  
205 mm, 8"



STILLE

Art. No. Art. Nr.	Tip size Arbeitsende (mm)
----------------------	---------------------------------

<b>FL523R</b>	10
<b>FL524R</b>	12
<b>FL525R</b>	15
<b>FL526R</b>	20
<b>FL527R</b>	25

Osteotomes  
Osteotome  
205 mm, 8"

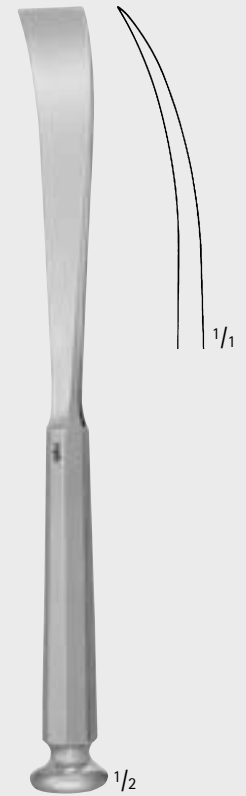

STILLE

Art. No. Art. Nr.	Tip size Arbeitsende (mm)
----------------------	---------------------------------

<b>FL553R</b>	10
<b>FL554R</b>	12
<b>FL555R</b>	15
<b>FL556R</b>	20
<b>FL557R</b>	25

Osteotomes, curved  
Osteotome, gebogen  
205 mm, 8"

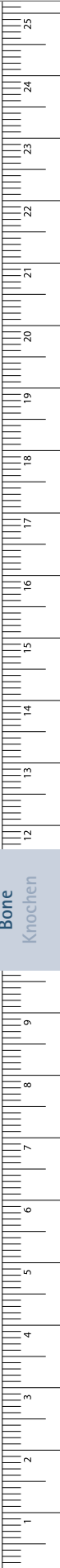

# Bone Instruments – Knocheninstrumente

## Chisels, Gouges, Osteotomes

### Flach- und Hohlmeißel, Osteotome

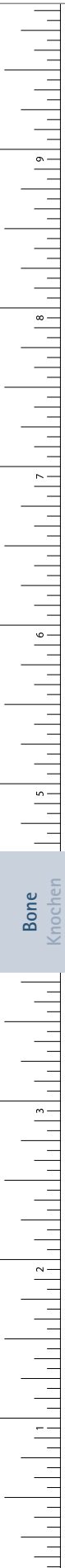

Bone  
Knochen



Art. No. Art. Nr.	Tip size Arbeitsende (mm)
D0750R	10
D0752R	15
D0754R	20

Chisel  
Flachmeißel  
200 mm, 7 7/8"



Art. No. Art. Nr.	Tip size Arbeitsende (mm)
D0751R	10
D0753R	15
D0755R	20

Chisel, curved  
Flachmeißel, gebogen  
200 mm, 7 7/8"



LEXER-MINI

Art. No. Art. Nr.	Tip size Arbeitsende (mm)
FL380R	4
FL381R	6
FL382R	8
FL383R	10
FL384R	12

Osteotome  
Osteotom  
180 mm, 7"



LEXER-MINI

Art. No. Art. Nr.	Tip size Arbeitsende (mm)
FL390R	4
FL391R	6
FL392R	8
FL393R	10
FL394R	12

Gauge  
Hohlmeißel  
180 mm, 7"

## Bone Instruments – Knocheninstrumente

Gouges, Chisels, Osteotomes

Hohlmeißel, Meißel, Osteotome



LEXER

Art. No. Art. Nr.	Tip size Arbeitsende (mm)
----------------------	---------------------------------

FL401R	5
FL402R	7
FL403R	10
FL405R	15
FL406R	20
FL407R	25
FL408R	30

Osteotome

Osteotom

225 mm, 8 7/8"



LEXER

Art. No. Art. Nr.	Tip size Arbeitsende (mm)
----------------------	---------------------------------

FL411R	5
FL412R	7
FL413R	10
FL415R	15
FL416R	20
FL417R	25
FL418R	30

Gauge

Hohlmeißel

225 mm, 8 7/8"



OBWEGESER

Art. No. Art. Nr.	Tip size Arbeitsende (mm)
----------------------	---------------------------------

OL385R	8
OL386R	12
OL387R	16

Chisel, blunt

Meißel, stumpf

220 mm, 8 3/4"

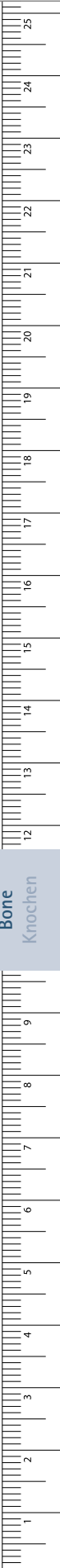

## Bone Instruments – Knocheninstrumente

### Sterilizable Grinding Stones

### Sterilisierbare Schleifsteine

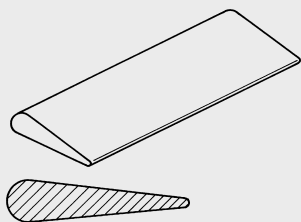

**\*DB090**

fine grain, feine Körnung

**\*DB091**

medium grain, mittlere Körnung  
India Corund grinding stone, beige  
for sharpening and pregrinding of very  
blunt instruments

India-Korund-Schleifsteine, beige  
zum Formen und Vorschleifen sehr  
stumpfer Instrumente

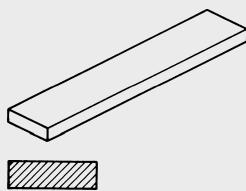

**\*DB095**

Original Arkansas grinding stone,  
grey-white, for repeated grinding on  
scalars and curettes as well as for  
finishing

Original Arkansas-Schleifstein, grauweiß,  
zum wiederholten Aufschleifen  
sowie Finieren von Scalern und  
Küretten

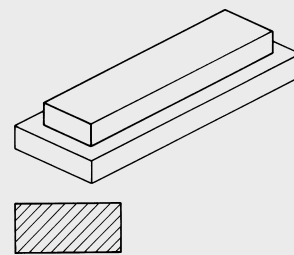

**DB096**

Super Arkansas grinding stone, white,  
for repeated grinding on scalars and  
curettes as well as for finishing  
Stone in wooden case

Super-Arkansas-Schleifstein, weiß,  
für das mehrmalige Aufschleifen und  
Finieren von Scalern und Küretten  
Stein im Holzetui

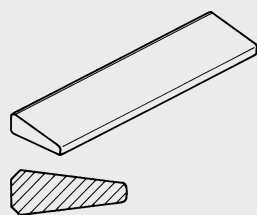

**DB097**

Super Arkansas grinding stone, white,  
for repeated grinding on scalars and  
curettes as well as for finishing

Super-Arkansas-Schleifstein, weiß  
für das mehrmalige Aufschleifen und  
Finieren von Scalern und Küretten

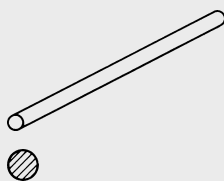

**\*DB098**

India Corund grinding stone, round  
file, brown beige, for deburring the  
working ends

100 mm, 4" long, diam. 6 mm  
India-Korund-Schleifstein, Rundfeile,  
braun-beige, zum Entgraten der  
Federkanten  
100 mm, 4" lang, Ø 6 mm

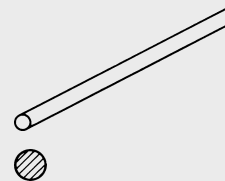

**\*DB086**

Plexiglas test rods, for checking  
cutting effect of scalars and curettes.  
Sales unit:

**PAK = Package of 6 pieces**  
Plexiglas-Teststäbchen, zur Kontrolle  
der Schneidewirkung von Scalern und  
Küretten.

Bestelleinheit:  
**PAK = Packung à 6 Stück**



**\*JG598**

Sterilit®, Aesculap oil for grinding  
stones

Contents: 50 ccm

Sterilit®, Aesculap-Schleifstein-Öl  
Inhalt: 50 ccm

■ Items marked \* are necessary for the  
basic equipment

■ Die mit \* gekennzeichneten Artikel:  
als Grundausstattung erforderlich



## Bone Instruments – Knocheninstrumente

## Mallets

## Hämmer

- Weights refer to the head / total weight of the mallets
- Die Gewichtsangaben beziehen sich auf das Kopf- / Gesamtgewicht des jeweiligen Hammers



Diam. 20 mm  
Ø 20 mm

**FL034**

Pair of spare discs  
Ersatzbackenpaar

1/2

MEAD

**FL035R** 160 g / 350 g  
with interchangeable  
plastic discs  
mit auswechselbaren  
Kunststoffbacken  
190 mm, 7 1/2"

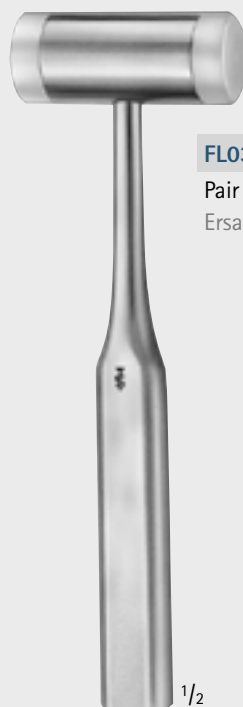

Diam. 25 mm  
Ø 25 mm

**FL037**

Pair of spare discs  
Ersatzbackenpaar

1/2

**FL036R** 135 g / 210 g  
with interchangeable  
plastic discs  
mit auswechselbaren  
Kunststoffbacken  
185 mm, 7 1/4"



Diam. 30 mm  
Ø 30 mm

COTTLE

**FL038R** 235 g / 320 g  
1 side flat,  
1 side convex  
1 Seite flach,  
1 Seite konvex  
185 mm, 7 1/4"

Bone  
Knochen

MILLIMETERS

# Bone Instruments – Knocheninstrumente

## Mallets

## Hämmer

- Weights refer to the head / total weight of the mallets
- Die Gewichtsangaben beziehen sich auf das Kopf- / Gesamtgewicht des jeweiligen Hammers



Bone  
Knochen



**FLO39R** 130 g / 235 g  
with one smooth and  
one rough surface  
mit einer flachen und  
einer aufgerauhten Fläche  
185 mm, 7 1/4"



**DF112R** 80 g / 165 g  
165 mm, 6 1/2"



**DX545R** 135 g / 415 g  
with interchangeable  
plastic discs  
mit auswechselbaren  
Kunststoffbacken  
200 mm, 7 7/8"

# Bone Instruments - Knocheninstrumente

## Mallets

## Hämmer



**FL045R** 200 g / 340 g  
with interchangeable  
plastic discs  
mit auswechselbaren  
Kunststoffbacken  
235 mm, 9 1/4"



**DF114R** 155 g / 220 g  
190 mm, 7 1/2"



**HAJEK**  
**FL044R** 140 g / 210 g  
220 mm, 8 3/4"

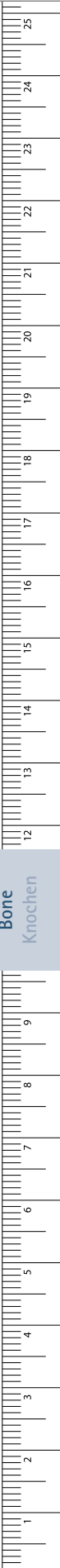



# Bone Instruments – Knocheninstrumente





## Tampers

### Stößel







   
**FL097R** **FL098R**  
 2.5 mm 3.5 mm

 <sup>1/2</sup>  
**PASSOW**  
**FL097R–FL098R**  
 120 mm, 4 3/4"

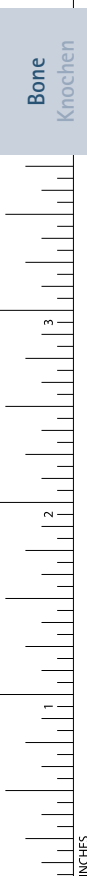
     
**FL093R** **FL094R** **FL095R** **FL096R**  
 Diam. / Ø 3 mm 5 mm 7 mm 9 mm

 <sup>1/2</sup>  
**FL093R–FL096R**  
 160 mm, 6 1/4"



    
**FF913R** **FF914R** **FF915R**  
 Diam. / Ø 3 mm 5 mm 8 mm

 <sup>1/2</sup>  
**CASPAR**  
**FF913R–FF915R**  
 200 mm, 7 7/8"

# Bone Instruments - Knocheninstrumente

## Awls Ahlen

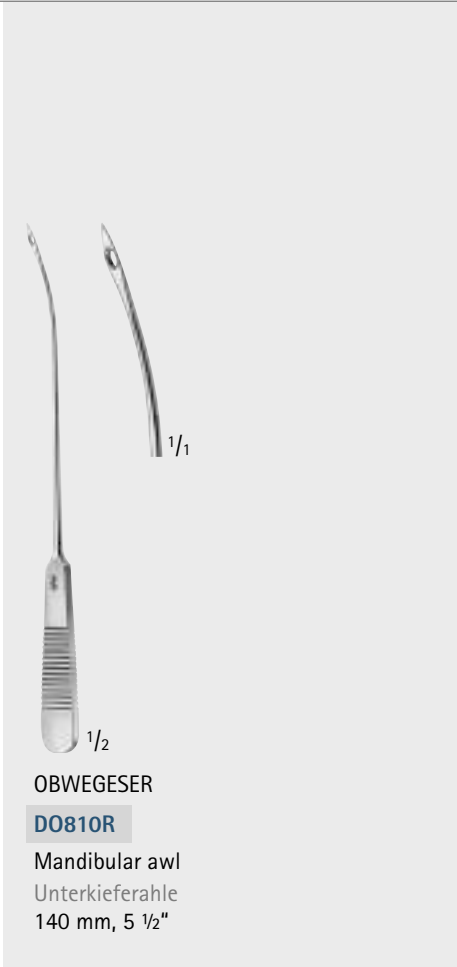

**OBWEGESER**  
**DO810R**  
Mandibular awl  
Unterkieferahle  
140 mm, 5 1/2"

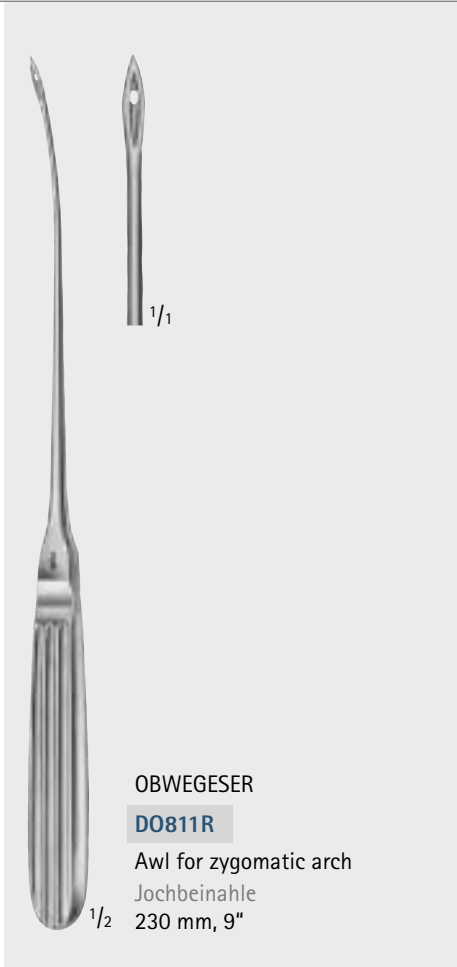

**OBWEGESER**  
**DO811R**  
Awl for zygomatic arch  
Jochbeinahle  
230 mm, 9"

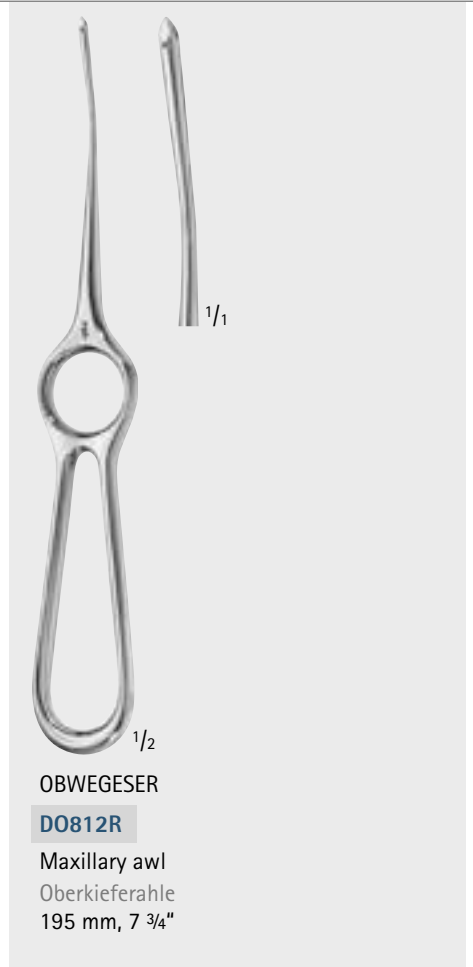

**OBWEGESER**  
**DO812R**  
Maxillary awl  
Oberkieferahle  
195 mm, 7 3/4"

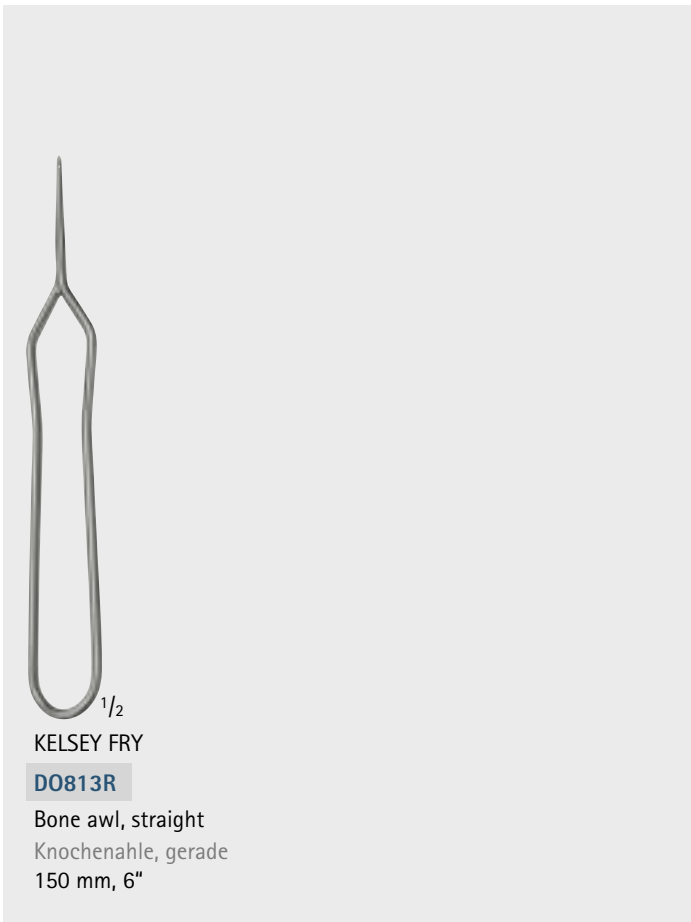

**KELSEY FRY**  
**DO813R**  
Bone awl, straight  
Knochenahle, gerade  
150 mm, 6"

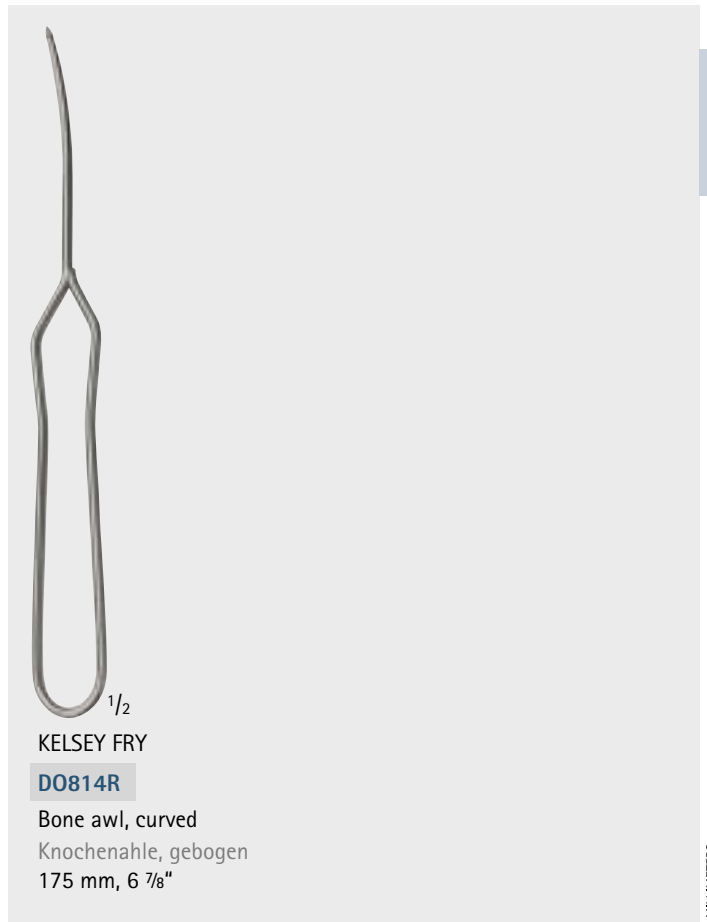

**KELSEY FRY**  
**DO814R**  
Bone awl, curved  
Knochenahle, gebogen  
175 mm, 6 7/8"

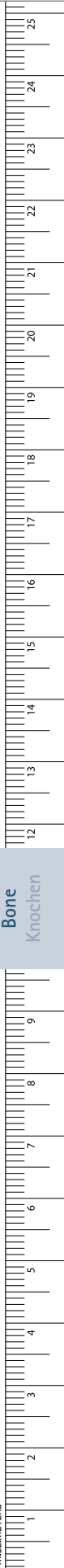

# Bone Instruments – Knocheninstrumente

## Bone Files and Rasps

### Knochen-Feilen und -Raspeln

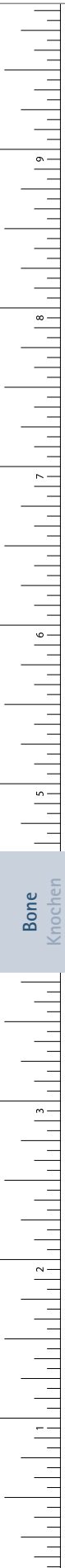

7.5 mm      9 mm

**OL401R**  
fine, chequered  
kariert, fein

**OL403R**  
coarse, chequered  
kariert, grob

**JOSEPH**  
**OL401R-OL403R**  
165 mm, 6 1/2"

8 mm      8 mm

**OL408R**  
fine teeth  
feine Zahnung

**OL409R**  
coarse teeth  
grobe Zahnung

**LEWIS**  
**OL408R-OL409R**  
175 mm, 6 7/8"

9 mm

**OL407R**  
down stroke  
auf Zug

**MALTZ**  
**OL407R**  
165 mm, 6 1/2"

9 mm      9 mm

**OL410R**  
up stroke  
auf Druck

**OL411R**  
down stroke  
auf Zug

**AUFRICHT**  
**OL410R-OL411R**  
220 mm, 8 3/4"

6.5 mm

**OL412R**

**GALLAHER**  
**OL412R**  
190 mm, 7 1/2"

7 mm

**OL413R**  
Diamond rasp,  
straight  
Diamant Raspel,  
gerade

180 mm, 7"

# Bone Instruments - Knocheninstrumente

## Bone Files and Rasps

### Knochen-Feilen und -Raspeln

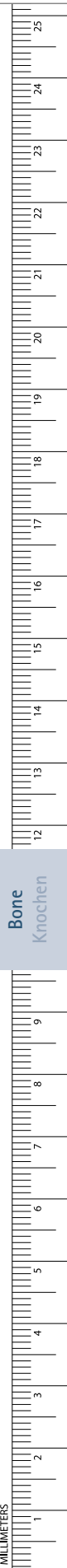
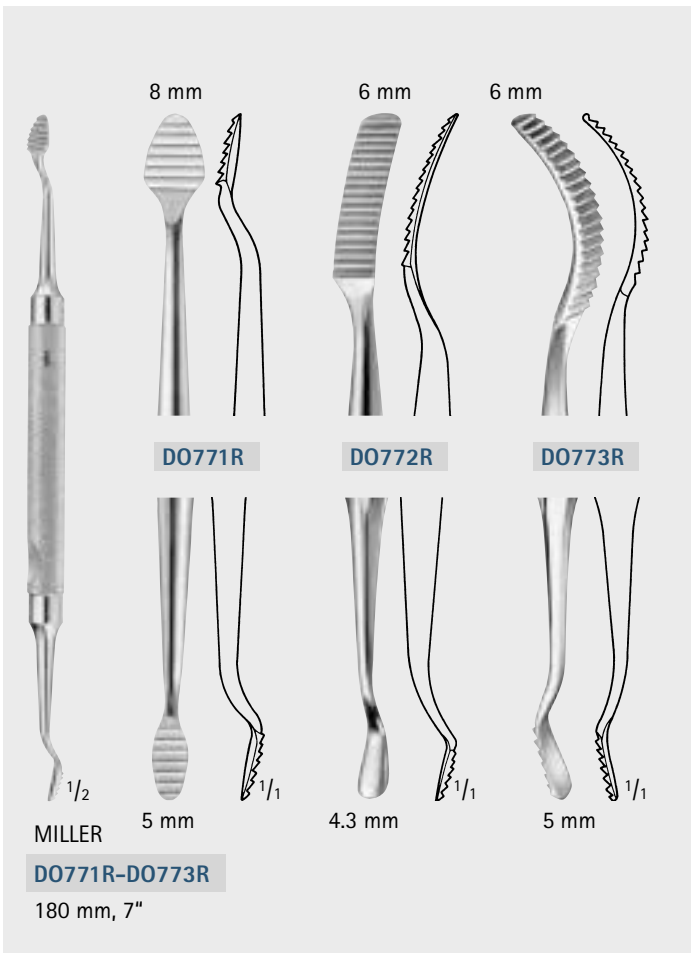
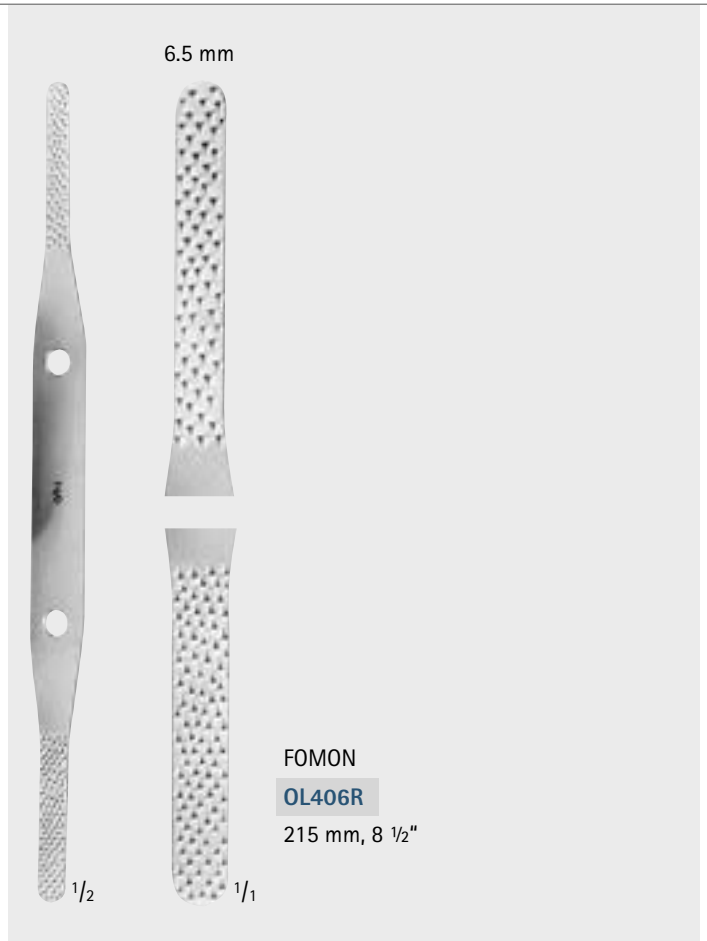
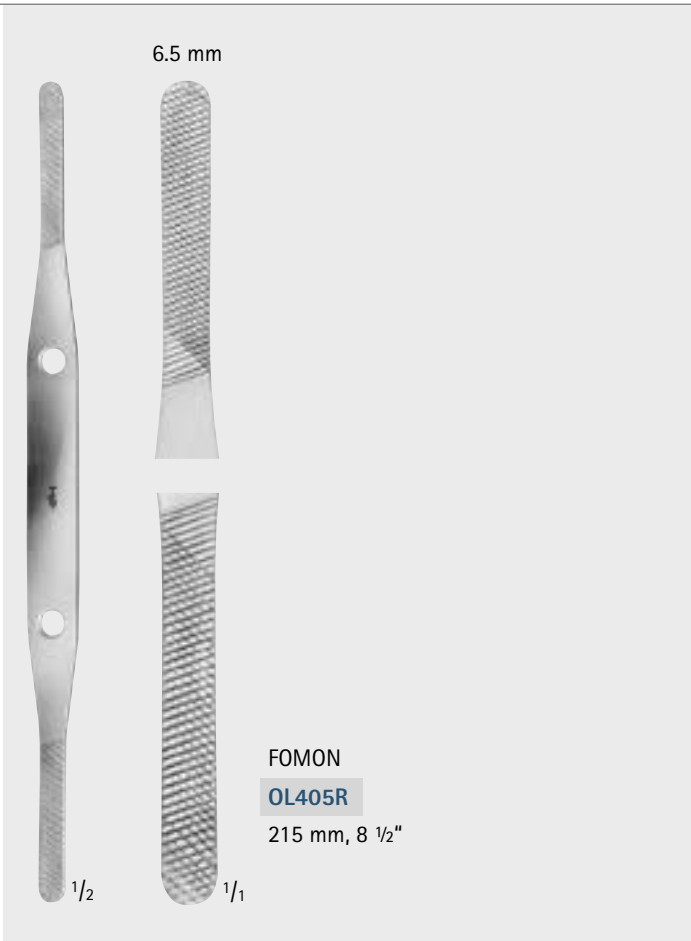

# Bone Instruments – Knocheninstrumente

## DUROGRIP® Rasps

### DUROGRIP® Raspeln

#### DUROGRIP® double-ended rasps with tungsten carbide inserts

- Identification: gold-plated handle
- Profile in 10 different fine graduations
- Sharp rasp profile allows progressive removal of cortical bone tissue
- Tungsten carbide inserts guarantee permanent sharpness and long life span
- Handy in use

#### DUROGRIP® Raspeln mit Hartmetall-Plättchen

- Kennzeichnung: Vergoldeter Griff
- Profil in 10 verschiedenen Feinabstufungen
- Scharfes Raspelprofil ermöglicht progressives Abtragen auch von corticalem Knochengewebe
- Die Hartmetall-Plättchen gewähren kontinuierliche Schärfe und Lebensdauer
- Handlich im Gebrauch



Bone  
Knochen

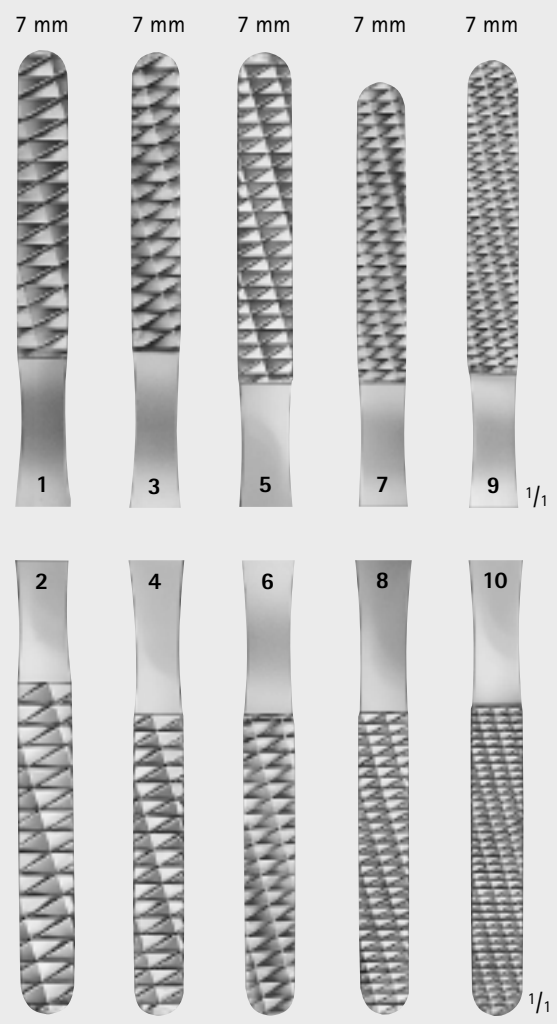

<b>OL421R-OL429R</b>		<b>OL421R</b>	<b>OL423R</b>	<b>OL425R</b>	<b>OL427R</b>	<b>OL429R</b>
210 mm, 8 1/4"	Teeth/Zähne	12/14	16/20	24/30	36/44	52/62



# Bone Instruments – Knocheninstrumente

## Bone Rongeurs

### Hohlmeißelzangen

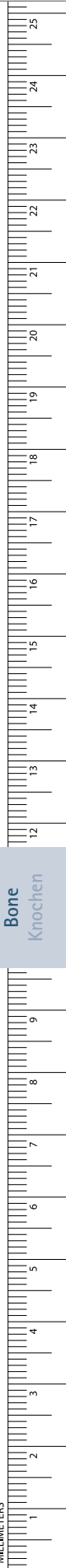
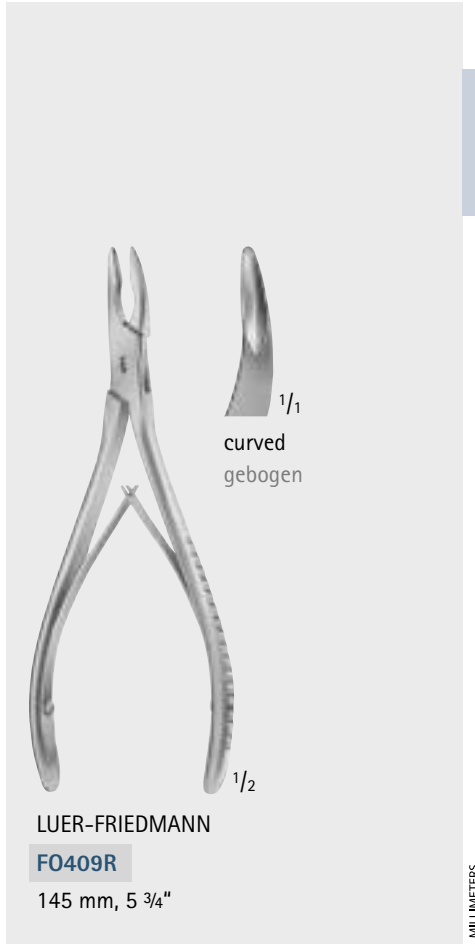
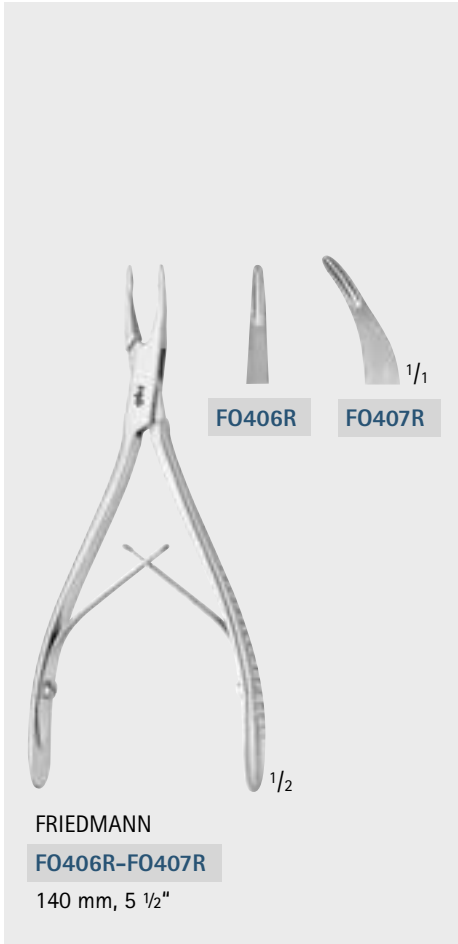
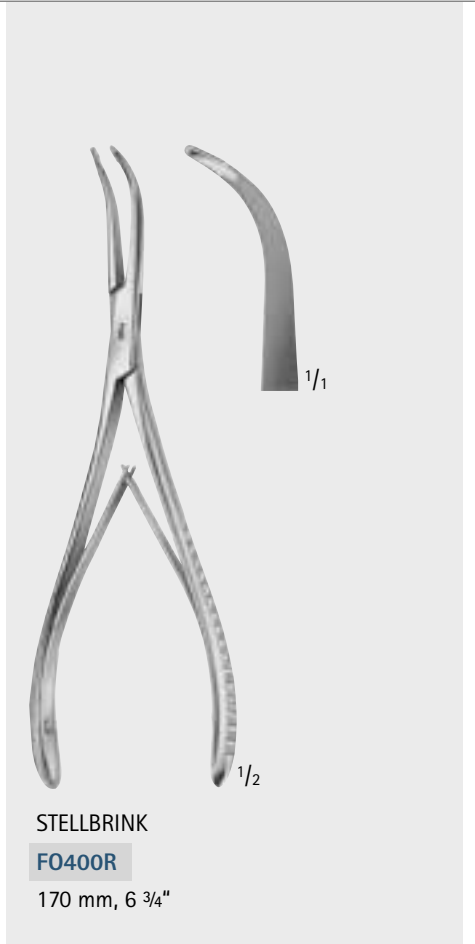
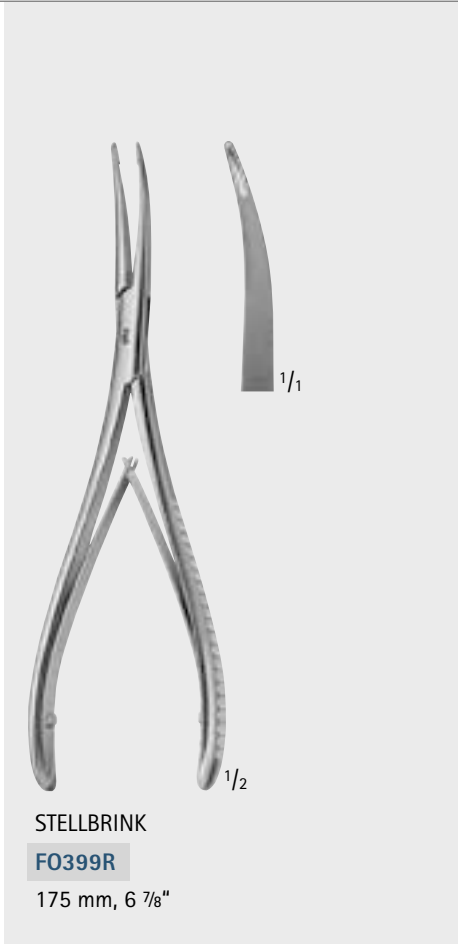
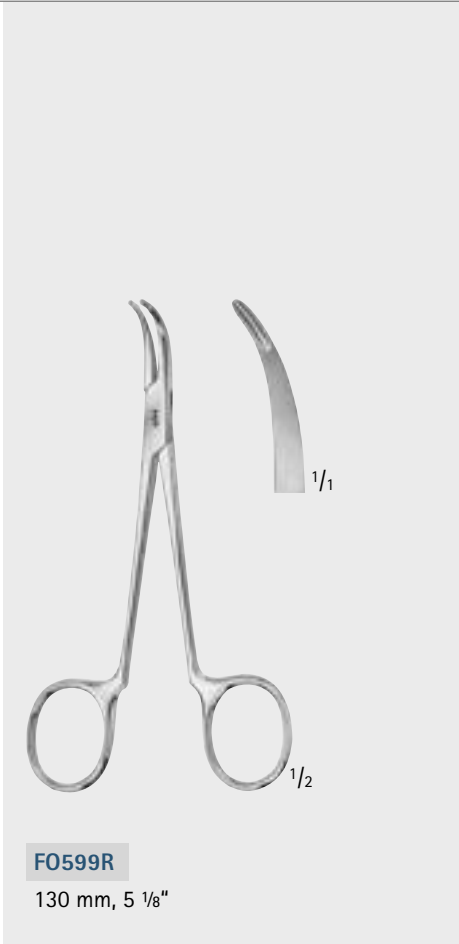

# Bone Instruments – Knocheninstrumente

## Bone Rongeurs

### Hohlmeißelzangen

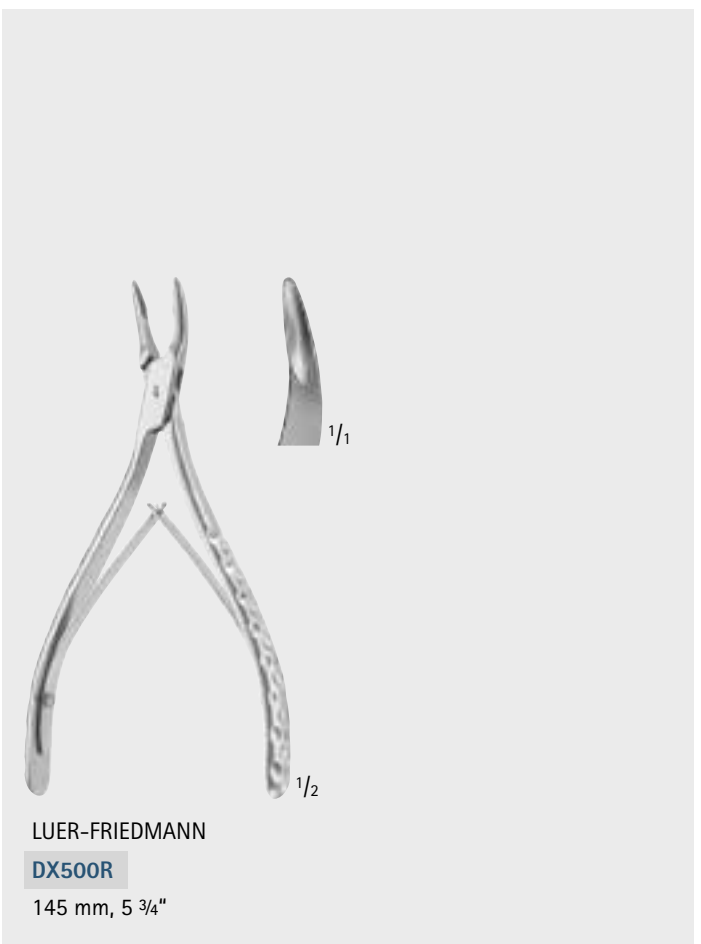
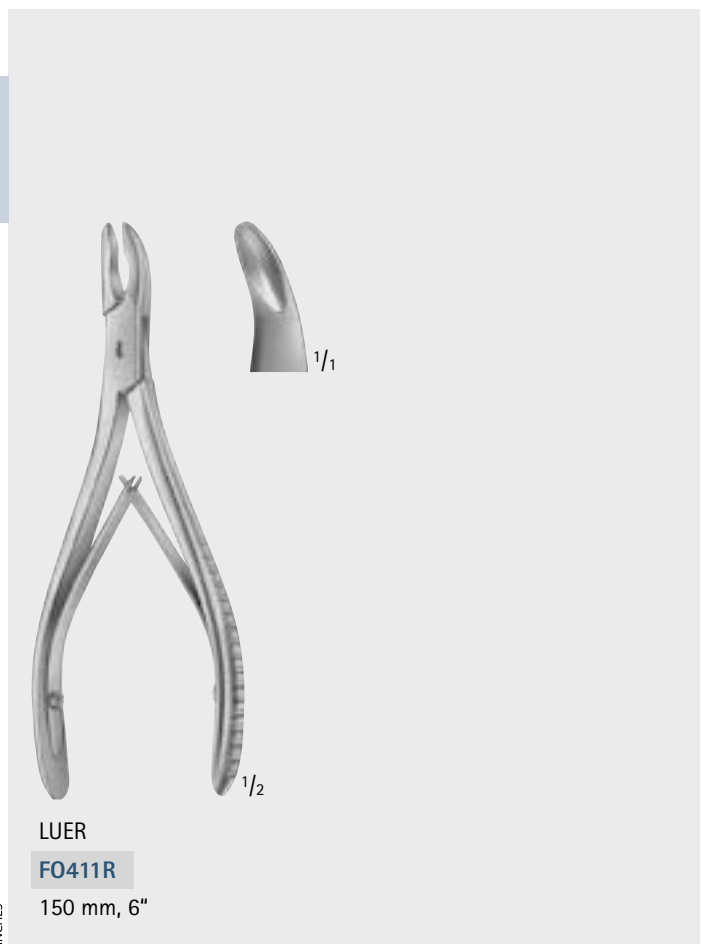
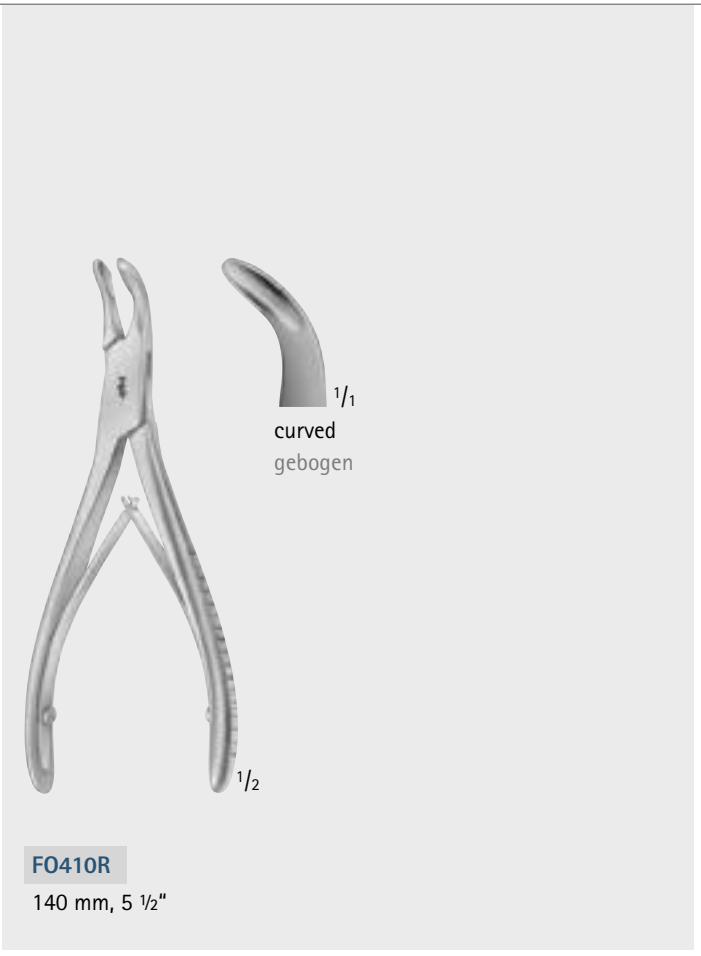
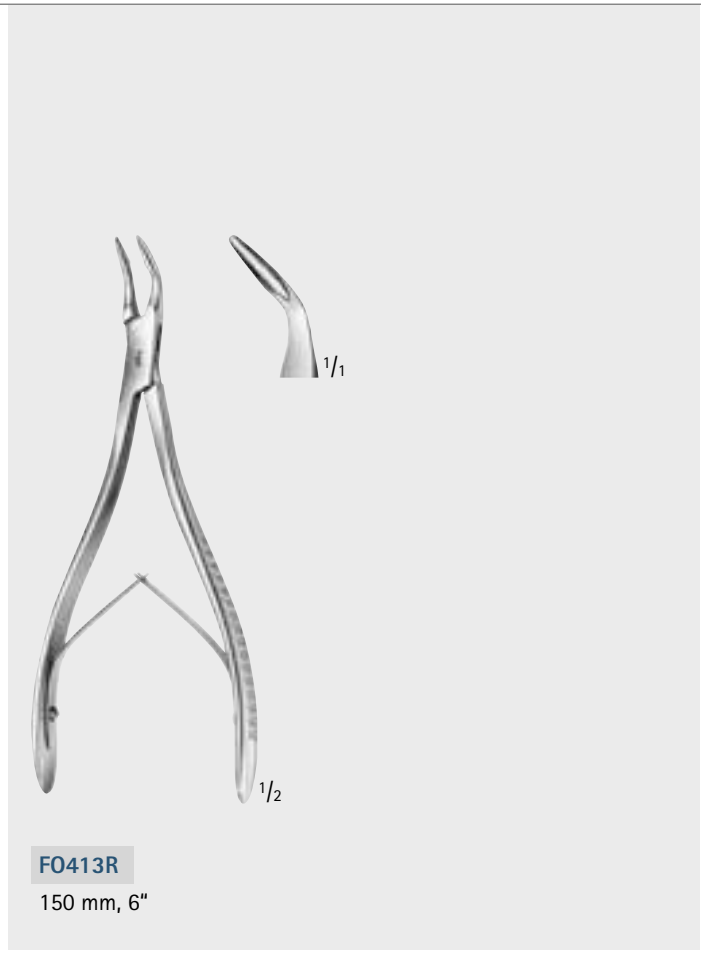

Bone  
Knochen

# Bone Instruments - Knocheninstrumente

## Bone Rongeurs

### Hohlmeißelzangen

curved  
gebogen

1/1

1/2

**LUER**  
**FO412R**  
155 mm, 6 1/8"

curved  
gebogen

1/1

1/2

**BLUMENTHAL**  
**FO415R**  
155 mm, 6 1/8"

1/1

1/2

**BLUMENTHAL**  
**FO416R**  
150 mm, 6"

curved to side  
seitwärts gebogen

1/1

1/2

**HAKANSSON**  
**FO428R**  
170 mm, 6 3/4"

FO430R

FO432R

1/1

1/1

1/2

**JANSEN**  
**FO430R-FO432R**  
175 mm, 6 7/8"

1/1

1/2

**BANE-HARTMANN**  
**FO457R**  
175 mm, 6 7/8"

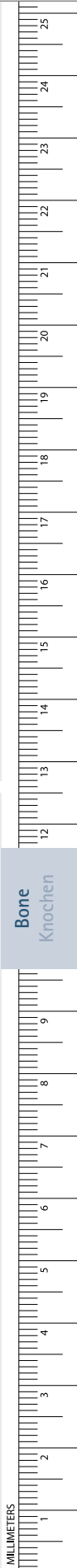

# Bone Instruments – Knocheninstrumente

## Bone Rongeurs

### Hohlmeißelzangen



**ALEXANDER**  
**FO440R**  
140 mm, 5 1/2"

**JANSEN**  
**FO442R**  
190 mm, 7 1/2"

s-shaped  
S-förmig

**LEMPERT**  
**MD617**  
155 mm, 6 1/8"

**LEMPERT**  
**FO450R-FO451R**  
200 mm, 7 7/8"

**BEYER**  
**FO453R**  
180 mm, 7"

curved  
gebogen

**MEAD**  
**FO455R**  
165 mm, 6 1/2"

curved  
gebogen

Bone  
Knochen

# Bone Instruments - Knocheninstrumente

## Bone Rongeurs

### Hohlmeißelzangen

**BÖHLER**  
**FO500R-FO502R**  
 155 mm, 6 1/8"

**MAYFIELD**  
**FO511R**  
 175 mm, 6 7/8"

**MARQUARDT**  
**FO520R**  
 200 mm, 7 7/8"

**BEYER**  
**FO514R-FO515R**  
 180 mm, 7"

**RUSKIN**  
**FO518R**  
 190 mm, 7 1/2"

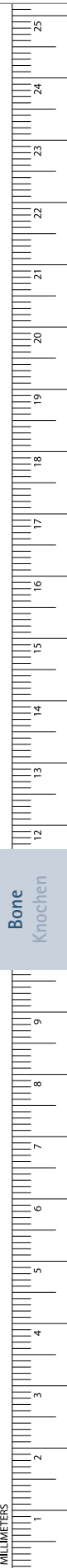

# Bone Instruments – Knocheninstrumente

## Bone Cutting Forceps

### Knochensplitterzangen

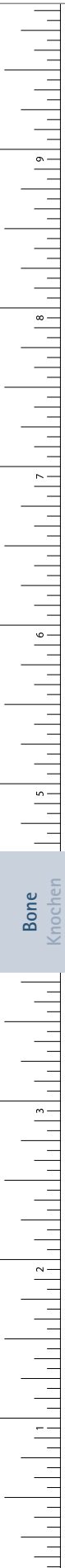

Bone  
Knochen

**FO601R**  
130 mm, 5 1/8"

**DX501R**  
130 mm, 5 1/8"

**STAMM**  
**FO604R**  
150 mm, 6"

**FO602R**  
170 mm, 6 3/4"

**KAZANJIAN**  
**OK378R**  
185 mm, 7 1/4"

## Bone Instruments – Knocheninstrumente

### Bone Cutting Forceps, Bone Shears

### Knochensplitterzangen, Knochenscheren

FO620R	FO622R	FO624R	FO626R
140 mm	170 mm	200 mm	220 mm
5 1/2"	6 3/4"	7 7/8"	8 3/4"

**LISTON**  
**FO620R-FO626R**  
Bone cutting forceps  
Knochensplitterzangen

FO632R	FO634R	FO636R
170 mm	200 mm	220 mm
6 3/4"	7 7/8"	8 3/4"

**LISTON**  
**FO632R-FO636R**  
Bone cutting forceps  
Knochensplitterzangen

**KILLIAN**  
**OP130R**  
Bone shear, double action  
Knochenschere, doppelt übersetzt  
200 mm, 7 7/8"

**MÜHLING**  
**FO216R**  
Bone shear, double action  
Knochenschere, doppelt übersetzt  
210 mm, 8 1/4"

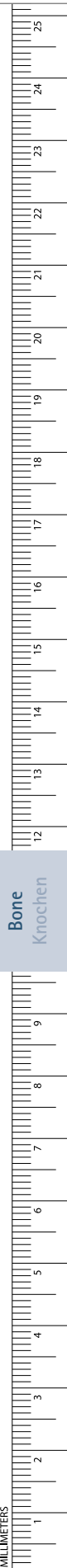

# Bone Instruments – Knocheninstrumente

## Bone Cutting Forceps

### Knochensplitterzangen



**BÖHLER**  
**FO610R**  
145 mm, 5 3/4"

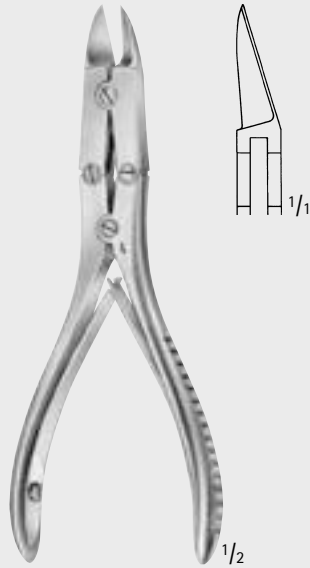

**BÖHLER**  
**FO611R**  
145 mm, 5 3/4"

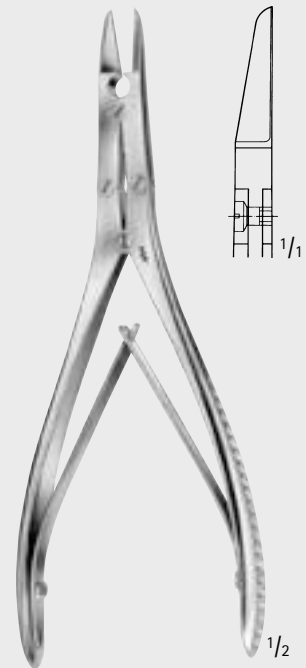

**FO612R**  
170 mm, 6 3/4"

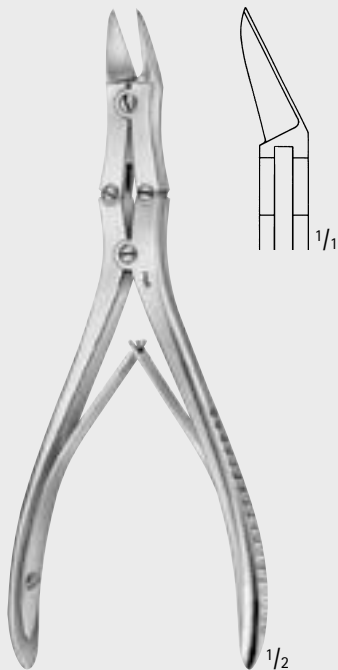

**MC INDOE**  
**FO614R**  
175 mm, 6 7/8"



**RUSKIN-LISTON**  
**FO640R**  
190 mm, 7 1/2"

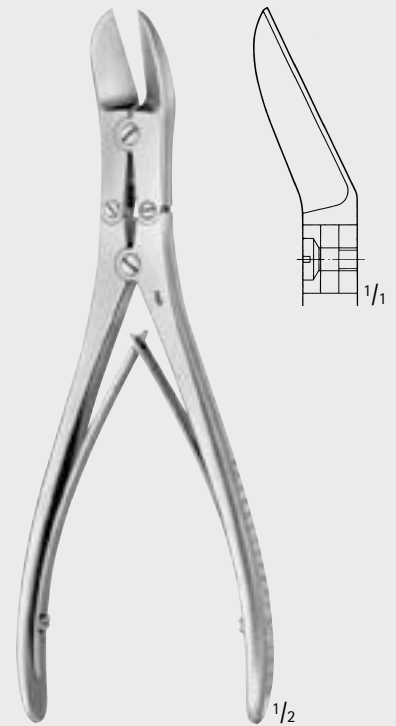

**RUSKIN-LISTON**  
**FO641R**  
190 mm, 7 1/2"

Bone  
Knochen



# Bone Instruments – Knocheninstrumente

## Rib Shears

## Rippenscheren



**FB870R**

230 mm, 9"



GLUCK

**FB873R**

190 mm, 7 1/2"



GIERTZ-STILLE

**FB890R**

250 mm, 9 3/4"



SAUERBRUCH

**FB881R**

for children  
für Kinder  
240 mm, 9 1/2"

SAUERBRUCH

**FB882R**

for adults  
für Erwachsene  
270 mm, 10 5/8"

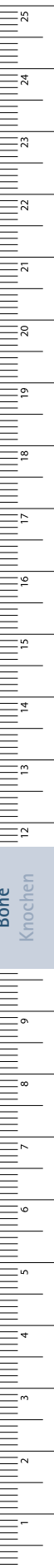

Bone  
Knochen

MILLIMETERS

# Bone Instruments – Knocheninstrumente

## Bone Holding Forceps

### Knochenhaltezangen



5 mm  
M<sub>1/1</sub>

**FO120R**  
200 mm, 7 7/8"

1/2

Detailed description: A pair of long-handled bone holding forceps with a 5 mm jaw opening. The jaws are curved and feature serrated inner surfaces. The handles are long and taper towards the ends.

**STRICKER**  
**DX601R**  
135 mm, 5 1/4"

1/2

Detailed description: A pair of bone holding forceps with a triangular frame. The jaws are short and curved, with serrated inner surfaces. The handles are circular and have a textured grip.

11 mm  
M<sub>1/1</sub>

**LANGENBECK**  
**FO127R**  
205 mm, 8"

1/2

Detailed description: A pair of long-handled bone holding forceps with an 11 mm jaw opening. The jaws are curved and feature serrated inner surfaces. The handles are long and taper towards the ends.

12 mm  
M<sub>1/1</sub>

**FERGUSON**  
**FO130R**  
205 mm, 8"

1/2

Detailed description: A pair of long-handled bone holding forceps with a 12 mm jaw opening. The jaws are curved and feature serrated inner surfaces. The handles are long and taper towards the ends.

Bone  
Knochen

# Bone Instruments - Knocheninstrumente

## Bone Holding Forceps

### Knochenhaltezangen

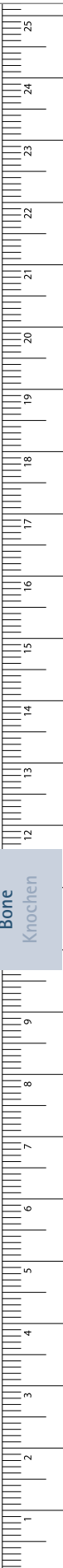
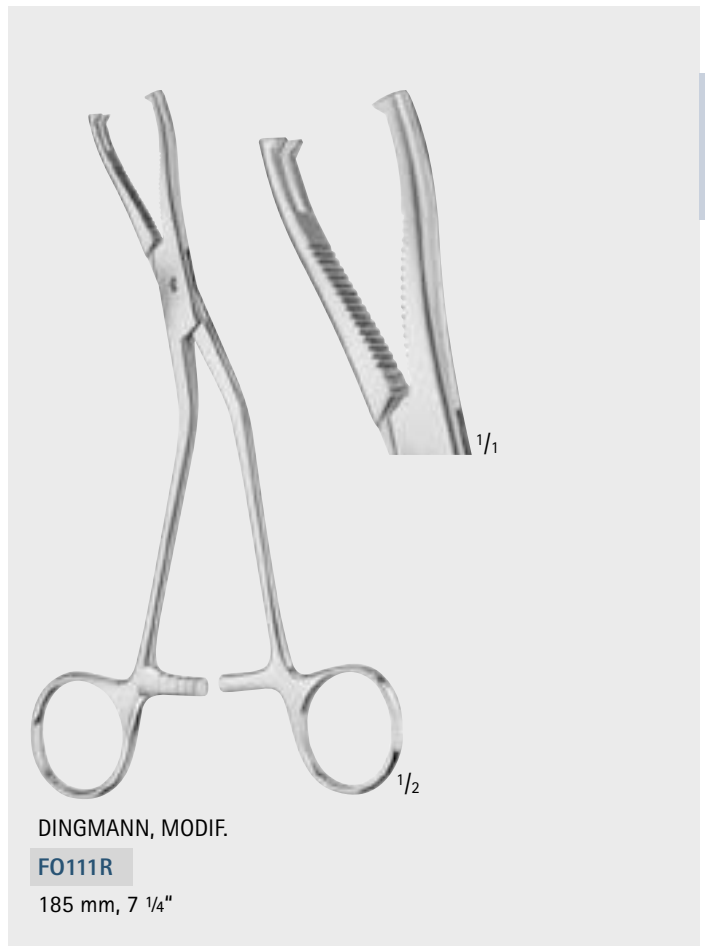
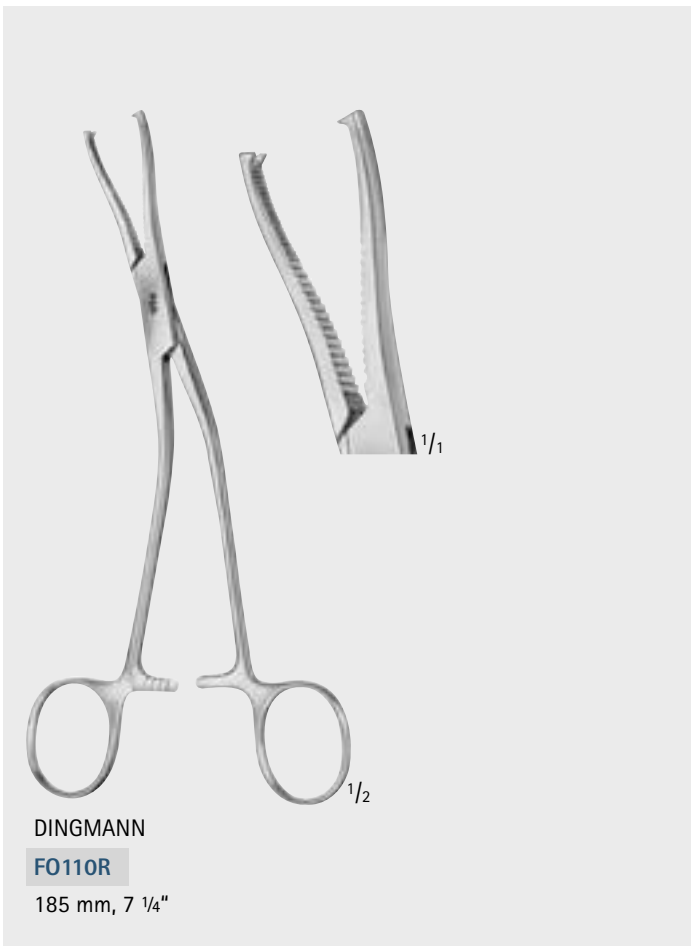
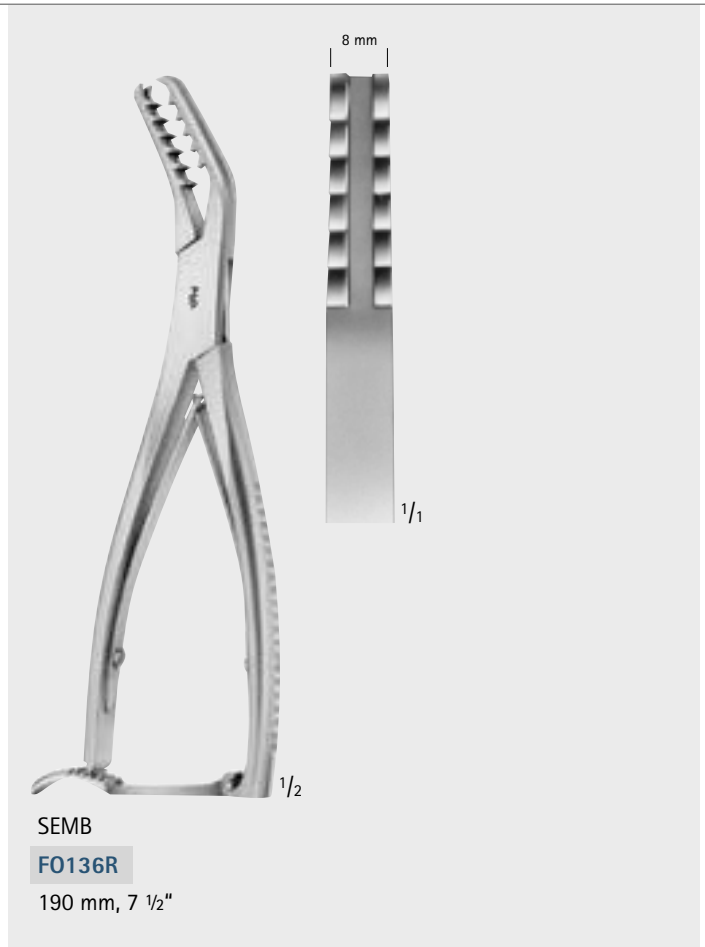
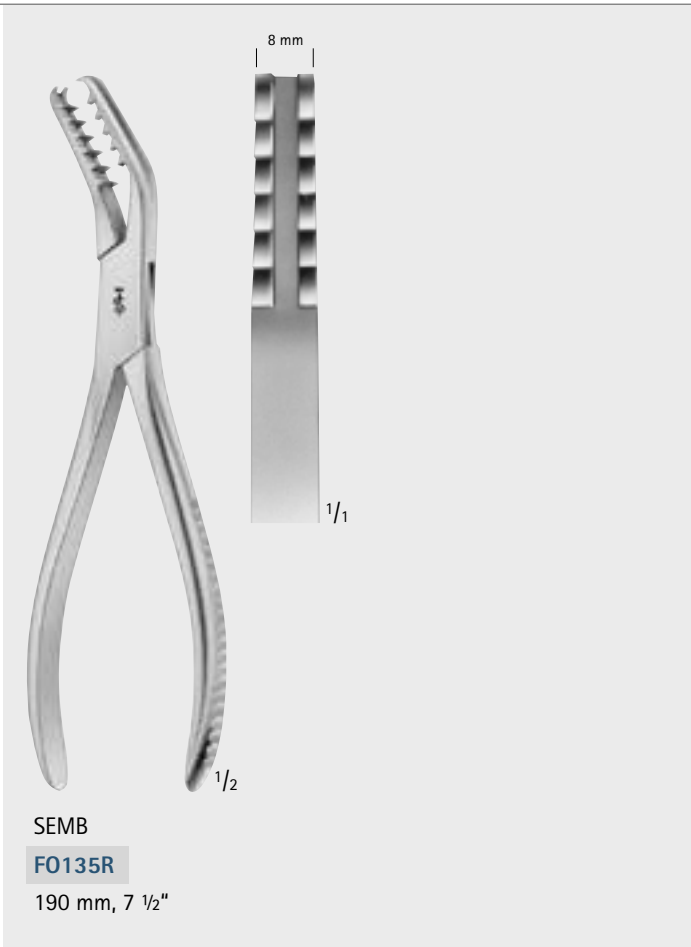

# Bone Instruments - Knocheninstrumente

## Reposition Forceps

### Repositionszangen

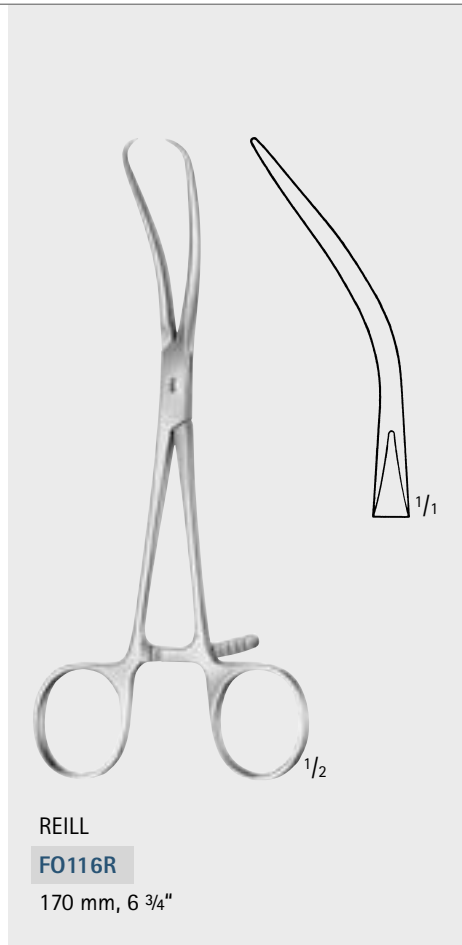

REILL

**FO116R**

170 mm, 6 3/4"

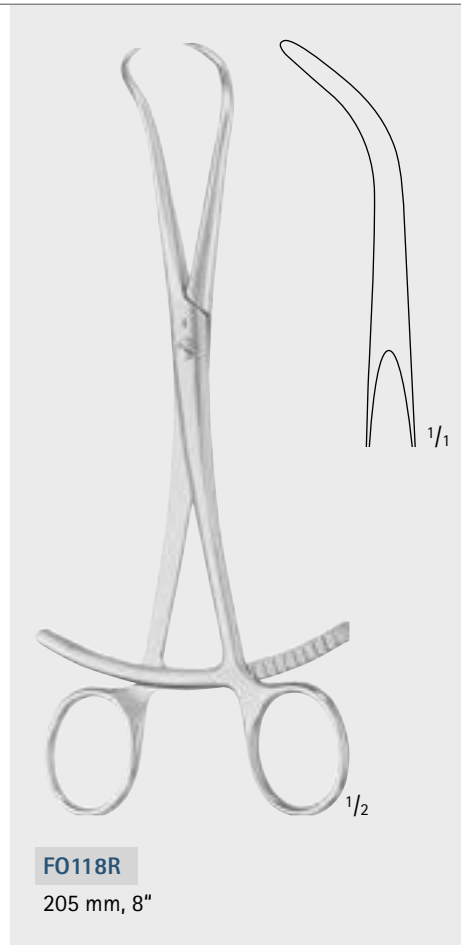

**FO118R**

205 mm, 8"

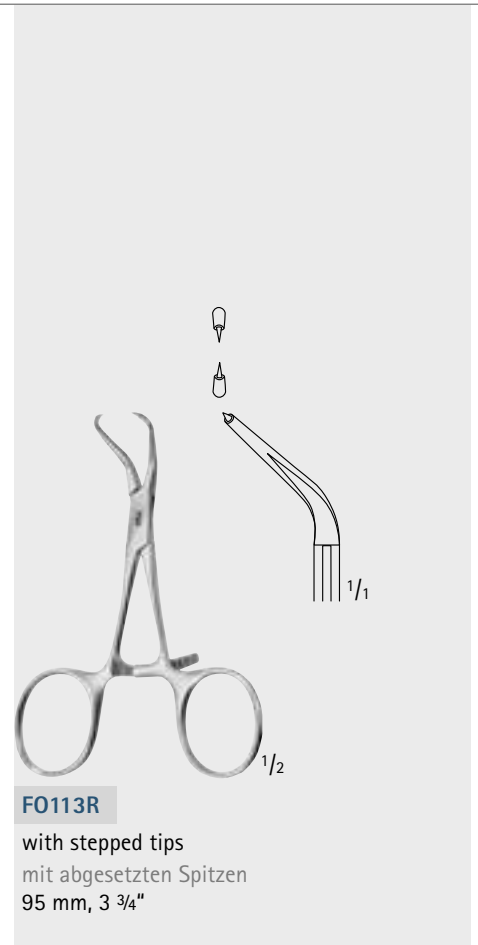

**FO113R**

with stepped tips  
mit abgesetzten Spitzen  
95 mm, 3 3/4"

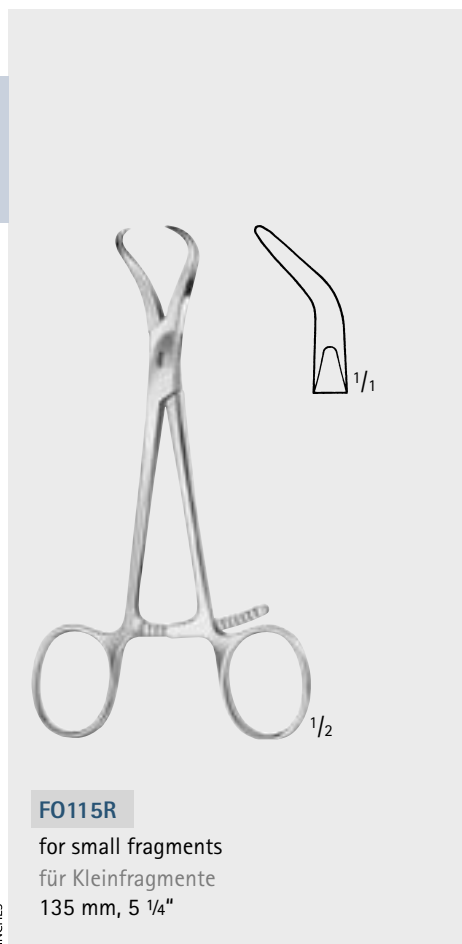

**FO115R**

for small fragments  
für Kleinfragmente  
135 mm, 5 1/4"

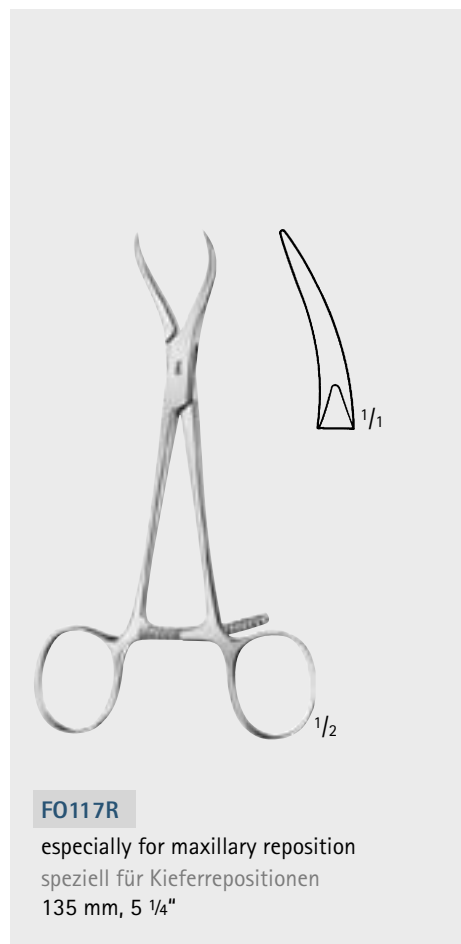

**FO117R**

especially for maxillary reposition  
speziell für Kieferrepositionen  
135 mm, 5 1/4"

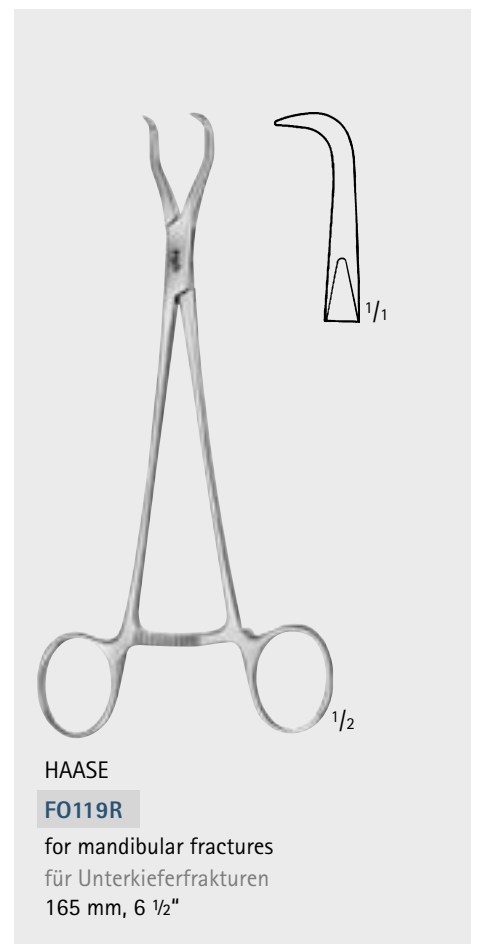

HAASE

**FO119R**

for mandibular fractures  
für Unterkieferfrakturen  
165 mm, 6 1/2"

# Bone Instruments – Knocheninstrumente

## Bone Punches Knochenstanzen

- Angled positions for punches
- Winkelstellungen bei Stanzen

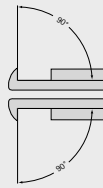

90° upbiting  
nach oben schneidend

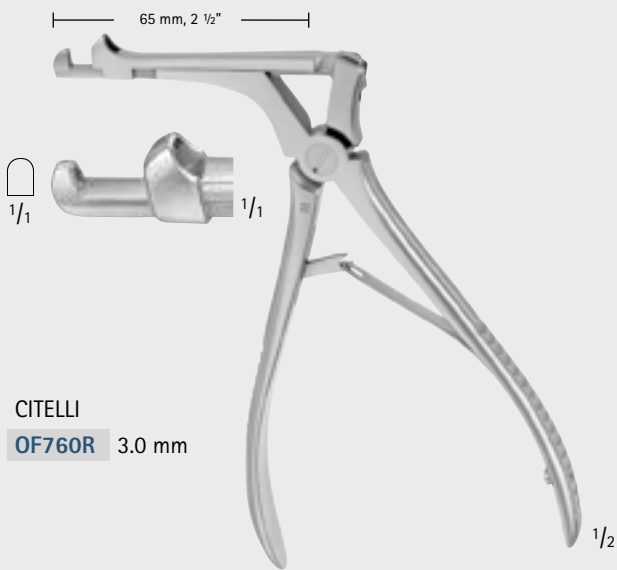

90° upbiting  
nach oben schneidend

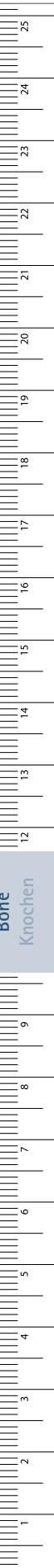
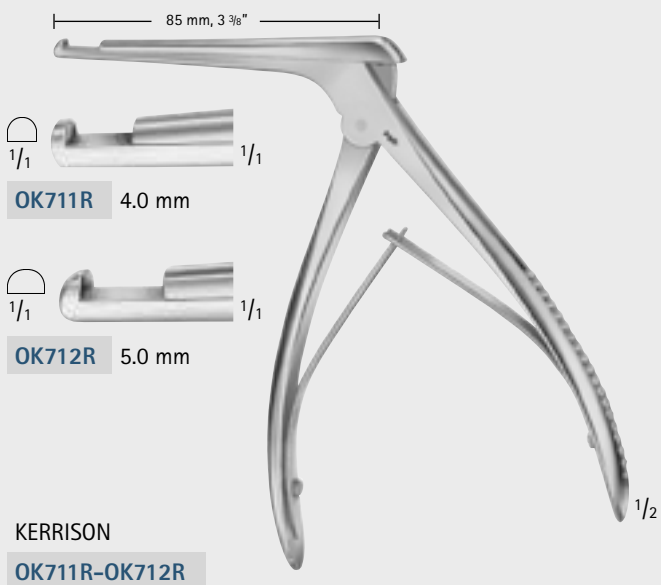

# Bone Instruments – Knocheninstrumente

## Bone Punches

### Knochenstanzen



90° downbiting  
nach oben schneidend

140 mm, 5 1/2"



OK740R 3.3 mm



OK742R 4.0 mm

HAJEK-KOFLER

OK740R-OK742R

90° downbiting  
nach unten schneidend

140 mm, 5 1/2"



HAJEK-KOFLER

OK741R 3.3 mm

# Bone Instruments – Knocheninstrumente

## Bone Punches Knochenstanzen

90° downbiting  
nach oben schneidend  
rotates 360°  
drehbar 360°

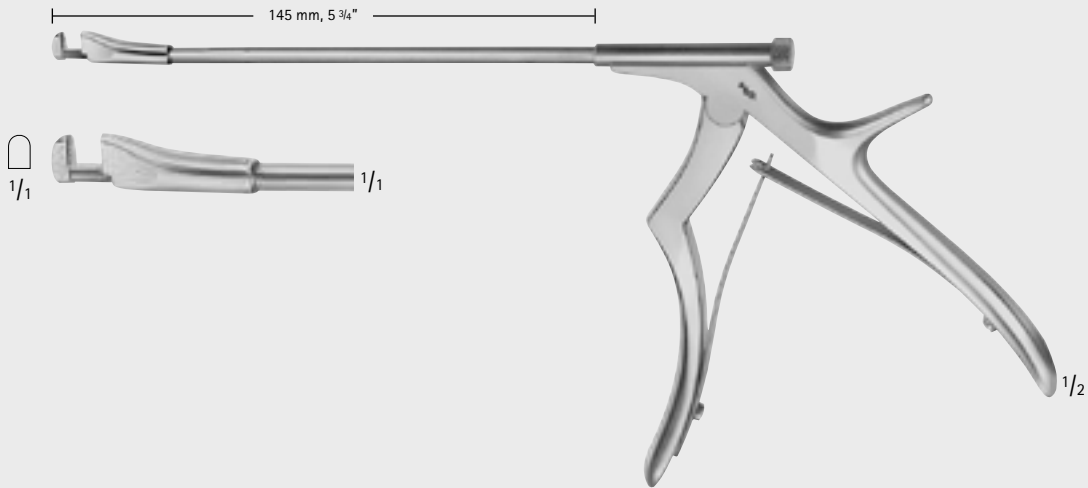

KOFLER  
OK737R 3.0 mm

90° upbiting  
nach oben schneidend  
rotates 360°  
drehbar 360°

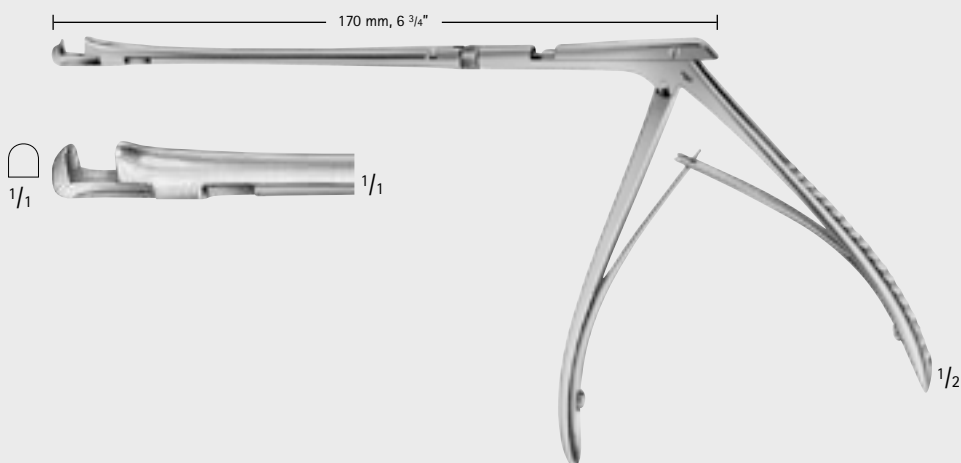

HAJEK-KOFLER  
OK745R 4.0 mm

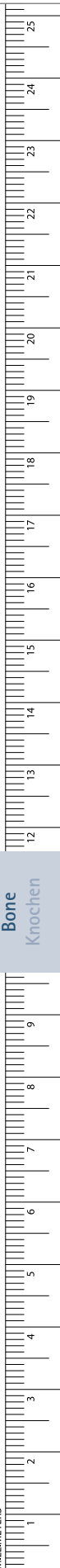

## Bone Instruments – Knocheninstrumente

### KERRISON Bone Punches

### KERRISON Knochenstanzen

## KERRISON Bone Punches



#### ■ Non detachable design

- The classical KERRISON with excellent cutting quality and durability
- Nicht zerlegbare Ausführung
- Die klassische KERRISON langlebig und mit exzellenter Schnittqualität

#### ■ Detachable design

- Can be taken apart easily without any tools for efficient cleaning
- Jaw ejector ensures easy removal of punched-out material
- Zerlegbare Ausführung
- Für eine effiziente Reinigung einfach und ohne Werkzeuge zerlegbar
- Auswerfer zur einfachen Entfernung von ausgestanztem Material

#### ■ Noir® detachable design

- Same as detachable design, but with black Noir® coating
- Reduces irritating light reflection
- Increases surface hardness for improved cutting characteristics and service life
- Noir® zerlegbare Ausführung
- Wie zerlegbare Ausführung aber mit schwarzer Noir® Beschichtung
- Reduziert irritierende Lichtreflexionen
- Erhöhte Oberflächeneigenschaft für bessere Schneideigenschaften und eine längere Lebensdauer

#### Complete product range:

- 90°/130° upwards/downwards cutting
- With regular/thin foot plate
- Standard/wide jaw opening
- Length:
  - 180 mm (7")
  - 200 mm (7 7/8")
  - 230 mm (9")
  - 280 mm (11")
- Width of jaw: 1-6 mm
- Half-sizes: 1.5 mm, 2.5 mm width

#### Komplettes Produktprogramm:

- 90°/130° nach oben/unten schneidend
- Mit Standard-Fußplatte/Dünnefußplatte
- Standard/Langhubstanzen
- Längen:
  - 180 mm (7")
  - 200 mm (7 7/8")
  - 230 mm (9")
  - 280 mm (11")
- Maulbreiten: 1-6 mm
- Zwischengrößen: 1,5 mm, 2,5 mm Maulbreite



## Bone Instruments – Knocheninstrumente

## KERRISON Bone Punches

## KERRISON Knochenstanzen

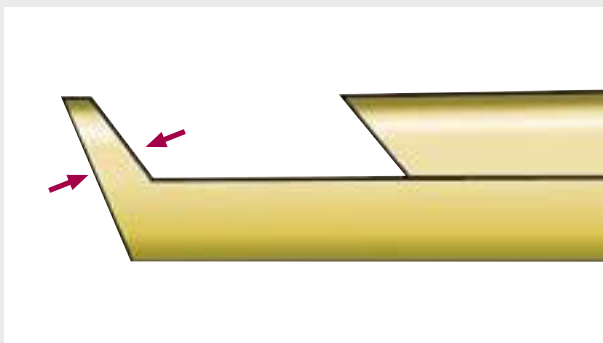
Features  
Eigenschaften

Kerrison punches with a **thin footplate** are marked with a golden distal end.

Die Kerrison Stanzen mit **Dünnpfußplatte** sind durch ein goldenes, distales Ende gekennzeichnet.

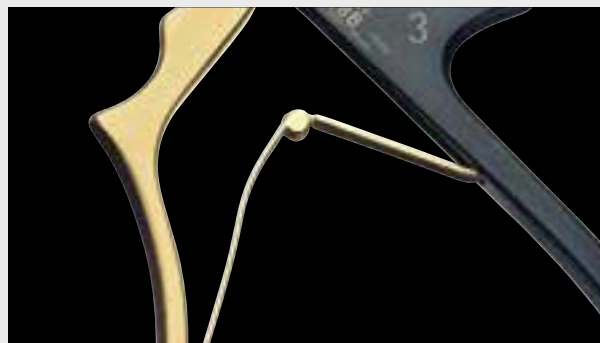

Kerrison Noir® punches with a **thin footplate** are marked with a golden inner handle.

Kerrison Noir® Stanzen mit **Dünnpfußplatte** sind durch ein goldenes, inneres Griffteil gekennzeichnet.



The golden spring stands for easy identification of detachable bone punches.

Die goldene Feder steht für einfache Erkennung von allen zerlegbaren Knochenstanzen.



Ejector – for the easy removal of punched-out material.

Auswerfer – zum einfachen Entfernen von ausgestanztem Material.



The **numerical code** ensures a safe and easy assignment and assembly of the two bone punch components which belong together.

Nummernkodierung – für die sichere Zuordnung beim Zusammensetzen der beiden zusammengehörenden Stanzenanteile.

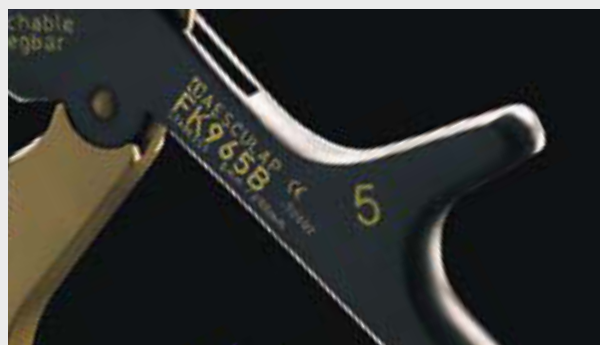

Large number for identification of jaw width at a glance.

Große Ziffer zur leichten Erkennung der Maulbreite auf einen Blick.

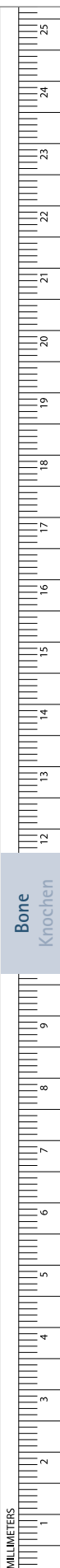

Bone  
Knochen

MILLIMETERS

## Bone Instruments – Knocheninstrumente

Noir® - Coated KERRISON Punches

Noir® KERRISON Knochenstanzen

Jaw position 130°, upwards  
Maulstellung 130°, oben

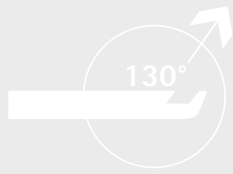

Shaft length Schaftlänge (mm)	Width Breite (mm)	Footplate Fußplatte	Art. No. Art. Nr.	Ejector Auswerfer	Jaw opening Hub (mm)
180	1.0	standard	FK900B	-	8
	1.0	thin	FK906B	-	8
	1.5	standard	FK911B	-	9
	1.5	thin	FK923B	-	9
	1.5	standard	FK941B	-	15
	2.0	standard	FK901B	✓	9
	2.0	thin	FK907B	✓	9
	2.0	standard	FK971B	✓	15
	2.5	standard	FK912B	✓	10
	2.5	thin	FK924B	✓	10
	3.0	standard	FK902B	✓	10
	3.0	thin	FK908B	✓	10
	3.0	standard	FK972B	✓	15
	4.0	standard	FK903B	✓	12
	4.0	thin	FK909B	✓	12
	4.0	standard	FK973B	✓	15
	5.0	standard	FK904B	✓	12
	5.0	thin	FK910B	✓	12
	5.0	standard	FK974B	✓	15
	6.0	standard	FK905B	✓	12
6.0	standard	FK975B	✓	15	
200	1.0	thin	FK961B	-	8
	1.5	standard	FK966B	-	9
	1.5	thin	FK968B	-	9
	2.0	standard	FK913B	✓	9
	2.0	thin	FK962B	✓	9
	2.0	standard	FK970B	✓	15
	2.5	standard	FK967B	✓	10
	2.5	thin	FK969B	✓	10
	3.0	standard	FK914B	✓	10
	3.0	thin	FK963B	✓	10
	3.0	standard	FK982B	✓	15
	4.0	standard	FK915B	✓	12
	4.0	thin	FK964B	✓	12
	4.0	standard	FK983B	✓	15
	5.0	standard	FK916B	✓	12
	5.0	thin	FK965B	✓	12
	5.0	standard	FK984B	✓	15
	6.0	standard	FK917B	✓	12
	6.0	standard	FK985B	✓	15
	230	1.0	standard	FK918B	-
2.0		standard	FK919B	✓	9
2.0		thin	FK925B	✓	9
3.0		standard	FK920B	✓	10
3.0		thin	FK926B	✓	10
4.0		standard	FK921B	✓	10
4.0		thin	FK927B	✓	12
5.0		standard	FK922B	✓	12
5.0		thin	FK928B	✓	12
280	2.0	thin	FK976B	✓	9
	3.0	thin	FK977B	✓	10
	4.0	thin	FK978B	✓	12
	5.0	thin	FK979B	✓	12

Bone  
Knochen



## Bone Instruments – Knocheninstrumente

Noir® - Coated KERRISON Punches

Noir® KERRISON Knochenstanzen



Jaw position 90°, upwards  
Maulstellung 90°, oben

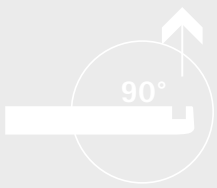

Shaft length Schaftlänge (mm)	Width Breite (mm)	Footplate Fußplatte	Art. No. Art. Nr.	Ejector Auswerfer	Jaw opening Hub (mm)
180	1.0	standard	FK948B	-	8
	2.0	standard	FK949B	✓	9
	3.0	standard	FK950B	✓	10
	4.0	standard	FK951B	✓	12
	5.0	standard	FK952B	✓	12
	6.0	standard	FK953B	✓	12

Width (mm)  
Breite (mm)

1.0 1.5 2.0 2.5 3.0 4.0 5.0 6.0 

Bone  
Knochen

MILLIMETERS

## Bone Instruments – Knocheninstrumente

### Detachable KERRISON Bone Punches

### Zerlegbare KERRISON Knochenstanzen

Jaw position 130°, upwards  
Maulstellung 130°, oben



Shaft length Schaftlänge (mm)	Width Breite (mm)	Footplate Fußplatte	Art. No. Art. Nr.	Ejector Auswerfer	Jaw opening Hub (mm)
180	1.0	standard	FK900R	-	8
	1.0	thin	FK906R	-	8
	1.5	standard	FK911R	-	9
	1.5	thin	FK923R	-	9
	2.0	standard	FK901R	✓	9
	2.0	thin	FK907R	✓	9
	2.0	standard	FK971R	✓	15
	2.5	standard	FK912R	✓	10
	2.5	thin	FK924R	✓	10
	3.0	standard	FK902R	✓	10
	3.0	thin	FK908R	✓	10
	3.0	standard	FK972R	✓	15
	4.0	standard	FK903R	✓	12
	4.0	thin	FK909R	✓	12
	4.0	standard	FK973R	✓	15
	5.0	standard	FK904R	✓	12
	5.0	thin	FK910R	✓	12
	5.0	standard	FK974R	✓	15
	6.0	standard	FK905R	✓	12
	6.0	standard	FK975R	✓	15
200	1.0	thin	FK961R	-	8
	1.5	standard	FK966R	-	9
	1.5	thin	FK968R	-	9
	2.0	standard	FK913R	✓	9
	2.0	thin	FK962R	✓	9
	2.0	standard	FK970R	✓	15
	2.5	standard	FK967R	✓	10
	2.5	thin	FK969R	✓	10
	3.0	standard	FK914R	✓	10
	3.0	thin	FK963R	✓	10
	3.0	standard	FK982R	✓	15
	4.0	standard	FK915R	✓	12
	4.0	thin	FK964R	✓	12
	4.0	standard	FK983R	✓	15
	5.0	standard	FK916R	✓	12
	5.0	thin	FK965R	✓	12
	5.0	standard	FK984R	✓	15
	6.0	standard	FK917R	✓	12
	6.0	standard	FK985R	✓	15
	230	2.0	standard	FK918R	-
2.0		standard	FK919R	✓	9
2.0		thin	FK925R	✓	9
3.0		standard	FK920R	✓	10
3.0		thin	FK926R	✓	10
4.0		standard	FK921R	✓	12
4.0		thin	FK927R	✓	12
5.0		standard	FK922R	✓	12
5.0		thin	FK928R	✓	12
280		2.0	thin	FK976R	✓
	3.0	thin	FK977R	✓	10
	4.0	thin	FK978R	✓	12
	5.0	thin	FK979R	✓	12

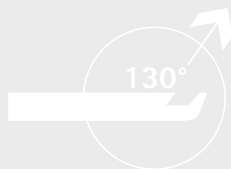

Bone  
Knochen

## Bone Instruments – Knocheninstrumente

## Detachable KERRISON Bone Punches

## Zerlegbare KERRISON Knochenstanzen



Jaw position 130°, downwards  
Maulstellung 130°, unten



Shaft length Schaftlänge (mm)	Width Breite (mm)	Footplate Fußplatte	Art. No. Art. Nr.	Ejector Auswerfer	Jaw opening Hub (mm)
180	1.0	standard	FK930R	-	8
	1.0	thin	FK936R	-	8
	2.0	standard	FK931R	✓	9
	2.0	thin	FK937R	✓	9
	3.0	standard	FK932R	✓	10
	3.0	thin	FK938R	✓	10
	4.0	standard	FK933R	✓	12
	4.0	thin	FK939R	✓	12
	5.0	standard	FK934R	✓	12
	5.0	thin	FK940R	✓	12
230	2.0	standard	FK943R	✓	9
	3.0	standard	FK944R	✓	10
	4.0	standard	FK945R	✓	12
	5.0	standard	FK946R	✓	12

Jaw position 90°, upwards  
Maulstellung 90°, oben

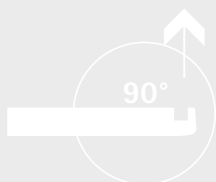

Shaft length Schaftlänge (mm)	Width Breite (mm)	Footplate Fußplatte	Art. No. Art. Nr.	Ejector Auswerfer	Jaw opening Hub (mm)
180	1.0	standard	FK948R	-	8
	2.0	standard	FK949R	✓	9
	3.0	standard	FK950R	✓	10
	4.0	standard	FK951R	✓	12
	5.0	standard	FK952R	✓	12
	6.0	standard	FK953R	✓	12

Jaw position 90°, downwards  
Maulstellung 90°, unten

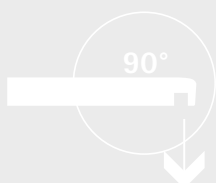

Shaft length Schaftlänge (mm)	Width Breite (mm)	Footplate Fußplatte	Art. No. Art. Nr.	Ejector Auswerfer	Jaw opening Hub (mm)
180	1.0	standard	FK954R	-	8
	2.0	standard	FK955R	✓	9
	3.0	standard	FK956R	✓	10
	4.0	standard	FK957R	✓	12
	5.0	standard	FK958R	✓	12

Width (mm)  
Breite (mm)

1.0 □

1.5 □

2.0 □

2.5 □

3.0 □

4.0 □

5.0 □

6.0 □

MILLIMETERS

## Bone Instruments – Knocheninstrumente

### Non Detachable KERRISON Bone Punches

### Nicht zerlegbare KERRISON Knochenstanzen

Jaw position 130°, upwards  
Maulstellung 130°, oben



Shaft length Schaftlänge (mm)	Width Breite (mm)	Footplate Fußplatte	Art. No. Art. Nr.	Jaw opening Hub (mm)
180	1.0	standard	FF715R	8
	1.0	thin	FF771R	8
	1.5	standard	FF638R	9
	1.5	thin	FF645R	9
	2.0	standard	FF717R	9
	2.0	thin	FF772R	9
	2.0	standard	FF677R	15
	2.5	standard	FF639R	10
	2.5	thin	FF646R	10
	3.0	standard	FF720R	10
	3.0	thin	FF773R	10
	3.0	standard	FF678R	15
	4.0	standard	FF724R	12
	4.0	thin	FF769R	12
	4.0	standard	FF679R	15
	5.0	standard	FF722R	12
	5.0	thin	FF770R	12
	5.0	standard	FF680R	15
6.0	standard	FF726R	12	
200	1.0	thin	FF661R	8
	1.5	standard	FF649R	9
	1.5	thin	FF658R	9
	2.0	standard	FF737R	9
	2.0	thin	FF662R	9
	2.0	standard	FF660R	15
	2.5	standard	FF657R	10
	2.5	thin	FF659R	10
	3.0	standard	FF738R	10
	3.0	thin	FF663R	10
	3.0	standard	FF739R	15
	4.0	standard	FF727R	12
	4.0	thin	FF664R	12
	4.0	standard	FF745R	15
	5.0	standard	FF728R	12
	5.0	thin	FF665R	12
	5.0	standard	FF751R	15
	6.0	standard	FF729R	12
6.0	standard	FF753R	15	
230	2.0	standard	FF682R	9
	2.0	thin	FF734R	8
	2.0	thin	FF746R	9
	3.0	standard	FF683R	10
	3.0	thin	FF747R	10
	4.0	standard	FF684R	12
	4.0	thin	FF748R	12
	5.0	standard	FF685R	12
	5.0	thin	FF749R	12
	5.0	standard	FF686R	12
280	2.0	thin	FF666R	9
	3.0	thin	FF667R	10
	4.0	thin	FF668R	12
	5.0	thin	FF669R	12



Bone  
Knochen

## Bone Instruments – Knocheninstrumente

## Non Detachable KERRISON Bone Punches

## Nicht zerlegbare KERRISON Knochenstanzen



Jaw position 130°, downwards  
Maulstellung 130°, unten



Shaft length Schaftlänge (mm)	Width Breite (mm)	Footplate Fußplatte	Art. No. Art. Nr.	Jaw opening Hub (mm)
180	1.0	standard	FF711R	8
	1.0	thin	FF781R	8
	2.0	standard	FF712R	9
	2.0	thin	FF782R	9
	3.0	standard	FF713R	10
	3.0	thin	FF783R	10
	4.0	standard	FF714R	12
	4.0	thin	FF784R	12
	5.0	standard	FF725R	12
	5.0	thin	FF785R	12
230	2.0	standard	FF692R	9
	3.0	standard	FF693R	10
	4.0	standard	FF694R	12
	5.0	standard	FF695R	12

Jaw position 90°, upwards  
Maulstellung 90°, oben

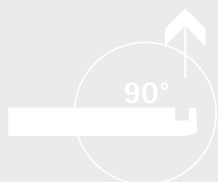

Shaft length Schaftlänge (mm)	Width Breite (mm)	Footplate Fußplatte	Art. No. Art. Nr.	Jaw opening Hub (mm)
180	1.0	standard	FF716R	8
	2.0	standard	FF718R	9
	3.0	standard	FF750R	10
	4.0	standard	FF752R	12
	5.0	standard	FF754R	12
	6.0	standard	FF755R	12

Jaw position 90°, downwards  
Maulstellung 90°, unten

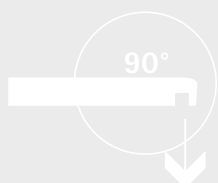

Shaft length Schaftlänge (mm)	Width Breite (mm)	Footplate Fußplatte	Art. No. Art. Nr.	Jaw opening Hub (mm)
180	1.0	standard	FF741R	8
	2.0	standard	FF719R	9
	3.0	standard	FF721R	10
	4.0	standard	FF742R	12
	5.0	standard	FF723R	12
	6.0	standard	FF743R	12

Width (mm)  
Breite (mm)

1.0 □

1.5 □

2.0 □

2.5 □

3.0 □

4.0 □

5.0 □

6.0 □

## Bone Instruments – Knocheninstrumente

DUROGRIP® Wire Holding Forceps, Wire Twisters

DUROGRIP® Drahtfasszangen, Drahtspannzangen



**LX176R**

Holding forceps for cerclage wire,  
with lateral jaws to avoid wire slipping off  
Drahtfasszange  
mit seitlichen Backen gegen Abrutschen des Drahtes  
170 mm, 6 3/4"



**BM110R**

Wire twister,  
ligature forceps  
Drahtspannzange,  
Ligaturzange  
155 mm, 6 1/8"

Bone  
Knochen

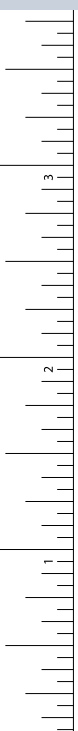

**BM111R**

Wire twister,  
ligature forceps  
Drahtspannzange,  
Ligaturzange  
150 mm, 6"



**BAUMGARTNER**

**BM112R**

Wire twister,  
ligature forceps  
Drahtspannzange,  
Ligaturzange  
200 mm, 7 7/8"



## Bone Instruments – Knocheninstrumente

Wire Bending Pliers, Round Nose Pliers, Flat Pliers

Drahtbiegezangen, Rundzangen, Flachzangen



**DP011R**

Wire bending pliers  
Drahtbiegezange  
140 mm, 5  $\frac{1}{2}$ "



**DP121R**

Round nose pliers, fine pattern  
Rundzange, feines Modell  
140 mm, 5  $\frac{1}{2}$ "

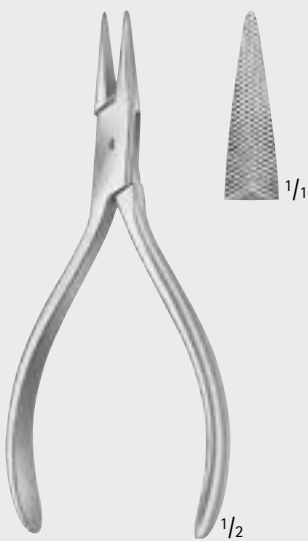

MARBURG MODELL

**DPO31R**

Wire bending pliers, with serrated jaws  
Flachzange, beidseitig kariert  
140 mm, 5  $\frac{1}{2}$ "



GOSLEE

**DP035R**

Wire bending pliers, one jaw smooth,  
one jaw serrated  
Flachzange, eine Seite glatt,  
eine Seite kariert  
140 mm, 5  $\frac{1}{2}$ "

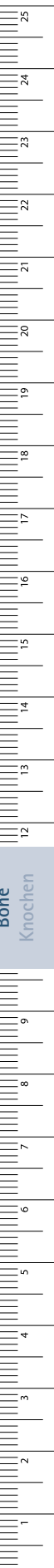

Bone  
Knochen

# Bone Instruments – Knocheninstrumente

## Wire Cutting Scissors

### Blech- und Drahtscheren

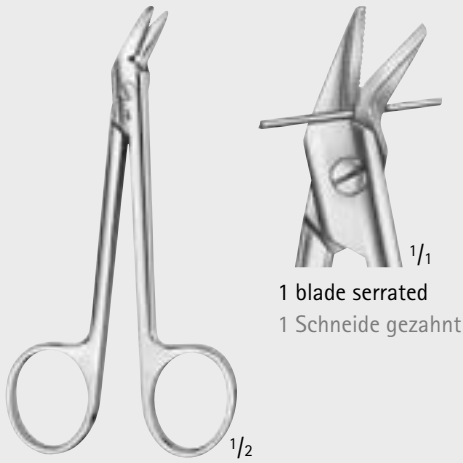

1 blade serrated  
1 Schneide gezahnt

**DP551R**

Wire scissors, 1 blade serrated for soft wire up to diam. 1.2 mm, for hard wire up to diam. 0.6 mm  
Drahtschere, 1 Schneide gezahnt für weichen Draht bis Ø 1,2 mm, für harten Draht bis Ø 0,6 mm  
120 mm, 4 3/4"

- DUROTIP®
  - Jaws with tungsten carbide inserts
- DUROTIP®
  - Maulteile mit Hartmetalleinlage

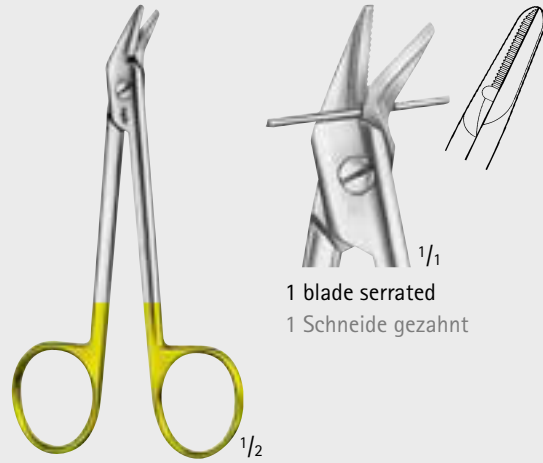

1 blade serrated  
1 Schneide gezahnt

**DP552R**

Wire scissors, 1 blade serrated for soft wire up to diam. 1.2 mm, for hard wire up to diam. 0.8 mm  
Drahtschere, 1 Schneide gezahnt für weichen Draht bis Ø 1,2 mm, für harten Draht bis Ø 0,8 mm  
120 mm, 4 3/4"

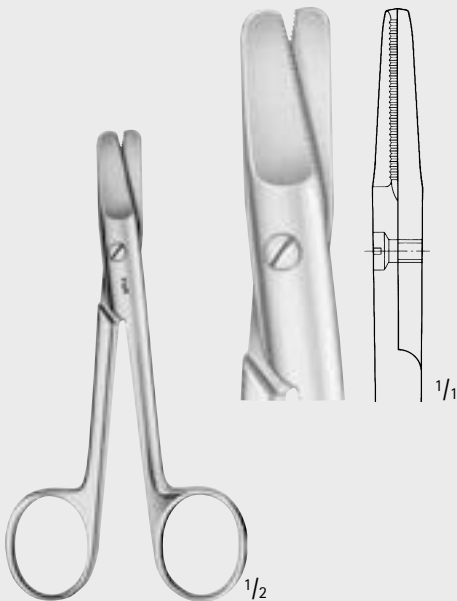

**HARVEY  
BC815R**

Wire cutting scissors, 1 blade serrated for soft wire up to diam. 0.4 mm, for hard wire up to diam. 0.3 mm  
Blech- und Drahtschere, 1 Schneide gezahnt für weichen Draht bis Ø 0,4 mm, für harten Draht bis Ø 0,3 mm  
125 mm, 5"

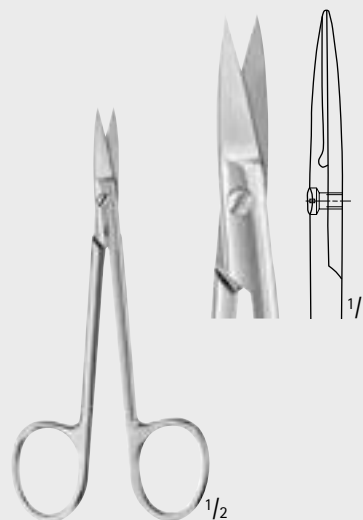

**GUILFORD-WRIGHT  
BC814R**

Wire scissors, blades serrated  
Drahtscherchen, Schneiden gezahnt  
110 mm, 4 1/4"

# Bone Instruments - Knocheninstrumente

## Wire Cutting Scissors

### Blech- und Drahtscheren



BEEBE

DP560R-DP569R

110 mm, 4 1/4"



DP560R

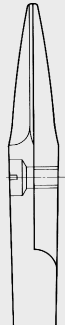

DP561R



DP563R

broad blades  
breite Blätter

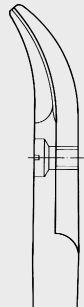

DP569R

1 blade serrated  
1 Schneide gezahnt

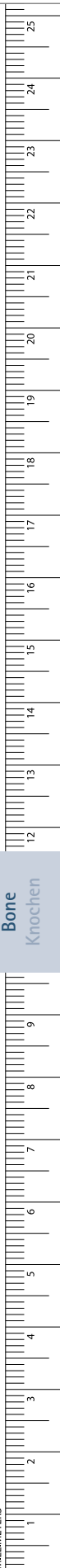
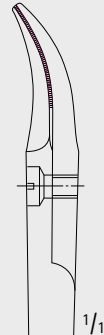

# Bone Instruments – Knocheninstrumente

## Wire Cutters

### Drahtschneidezangen



**ANGLE**  
**DP540R**  
Wire cutter  
for soft wire up to diam. 0.5 mm,  
for hard wire up to diam. 0.3 mm  
Drahtschneidezange  
für weichen Draht bis Ø 0,5 mm,  
für harten Draht bis Ø 0,3 mm  
130 mm, 5 1/8"

- specially hardened cutting edges
- speziell vergütete Schneiden

**ANGLE**  
**DP541R**  
Wire cutter  
for soft wire up to diam. 0.6 mm,  
for hard wire up to diam. 0.4 mm  
Drahtschneidezange  
für weichen Draht bis Ø 0,6 mm,  
für harten Draht bis Ø 0,4 mm  
130 mm, 5 1/8"

**DP505R**  
Wire cutter  
for soft wire up to diam. 1.5 mm,  
for hard wire up to diam. 1.2 mm  
Drahtschneidezange  
für weichen Draht bis Ø 1,5 mm,  
für harten Draht bis Ø 1,2 mm  
160 mm, 6 1/4"

**DP501R**  
Wire cutter  
for soft wire up to diam. 1.5 mm,  
for hard wire up to diam. 1.0 mm  
Drahtschneidezange  
für weichen Draht bis Ø 1,5 mm,  
für harten Draht bis Ø 1,0 mm  
150 mm, 6"

- specially hardened cutting edges
- speziell vergütete Schneiden

**DP530R**  
Wire cutter  
for soft wire up to diam. 1.5 mm,  
for hard wire up to diam. 1.0 mm  
Drahtschneidezange  
für weichen Draht bis Ø 1,5 mm,  
für harten Draht bis Ø 1,0 mm  
140 mm, 5 1/2"

# Bone Instruments – Knocheninstrumente

## Wire Cutters

### Drahtschneidezangen

- specially hardened cutting edges
- speziell vergütete Schneiden



#### DP520R

Wire cutter  
for soft wire up to diam. 1.5 mm,  
for hard wire up to diam. 1.0 mm  
Drahtschneidezange  
für weichen Draht bis Ø 1,5 mm,  
für harten Draht bis Ø 1,0 mm  
145 mm, 5 3/4"

- specially hardened cutting edges
- speziell vergütete Schneiden



#### LX150R

Wire cutter  
for soft wire up to diam. 2.0 mm,  
for hard wire up to diam. 1.5 mm  
Drahtschneidezange  
für weichen Draht bis Ø 2,0 mm,  
für harten Draht bis Ø 1,5 mm  
145 mm, 5 3/4"

- specially hardened cutting edges
- speziell vergütete Schneiden



#### LX158R

Wire cutters, front- and lateral  
cutting action  
for soft wire up to diam. 2.0 mm,  
for hard wire up to diam. 1.5 mm  
Kopf- und Seitenschneider  
für weichen Draht bis Ø 2,0 mm,  
für harten Draht bis Ø 1,5 mm  
180 mm, 7"

- specially hardened cutting edges
- speziell vergütete Schneiden

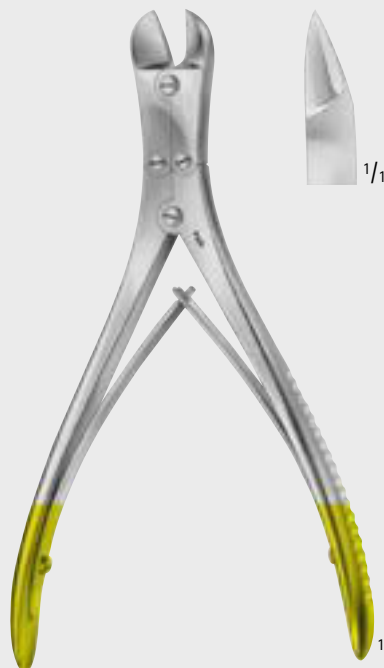

#### REILL

#### LX159R

Wire cutter  
for soft wire up to diam. 2.0 mm,  
for hard wire up to diam. 1.5 mm  
Drahtschneidezange  
für weichen Draht bis Ø 2,0 mm,  
für harten Draht bis Ø 1,5 mm  
175 mm, 6 7/8"

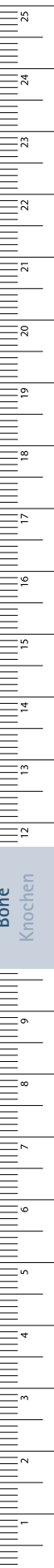

# Bone Instruments – Knocheninstrumente

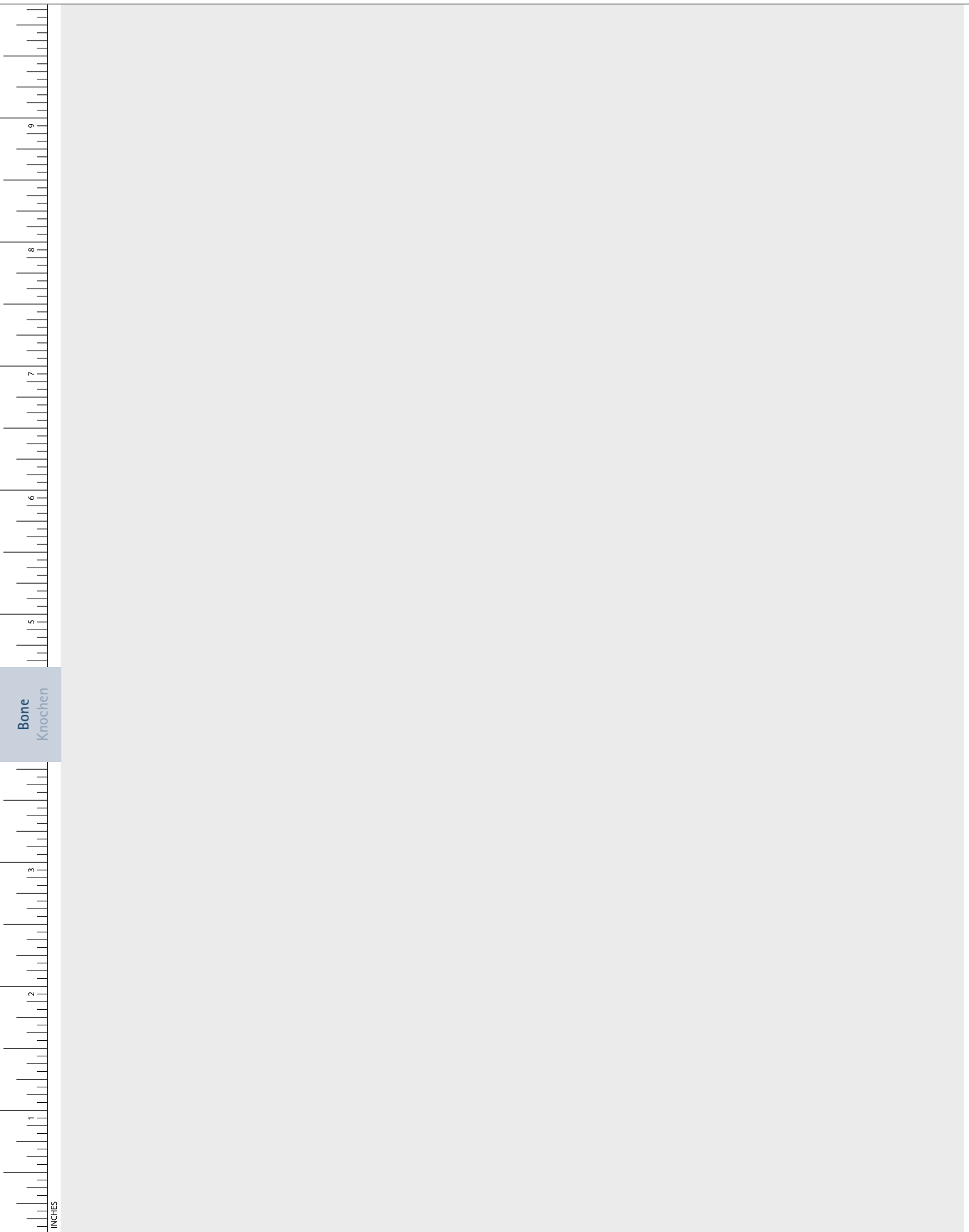

Retraktors, Hooks  
Retraktoren, Wundhaken



## Retractors, Hooks – Retraktoren, Wundhaken

### Tracheal Dilators

### Trachealdilatatoren

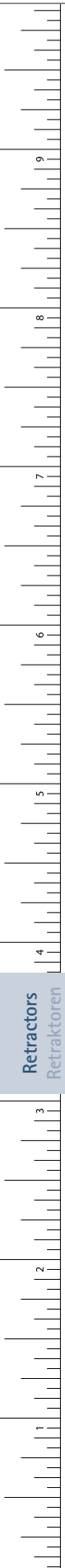

TROUSSEAU

**FA005R**

120 mm, 4 <sup>3</sup>/<sub>4</sub>"



LABORDE

**FA006R**

125 mm, 5"



LABORDE

**FA007R**

strong pattern  
kräftiges Modell  
135 mm, 5 <sup>1</sup>/<sub>4</sub>"

Retractors  
Retraktoren



# Retractors, Hooks – Retraktoren, Wundhaken

## Self-Retaining Retractors

### Wundspreizer

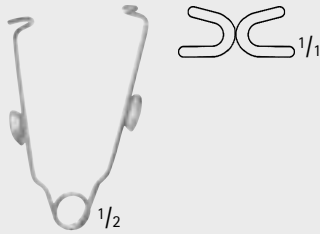

BOSE

**FA001R**

60 mm, 2 3/8"



FINSEN

**BV001R**

50 mm, 2"

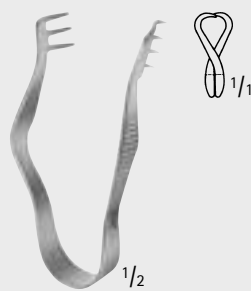

FINSEN

**BV002R**

70 mm, 2 3/4"

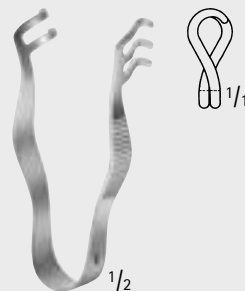

FINSEN MODIF.

**BV003R**

75 mm, 3"

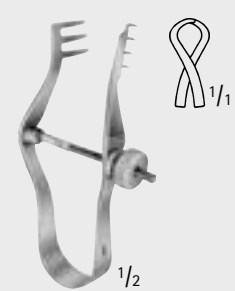

FINSEN

**BV005R**

70 mm, 2 3/4"

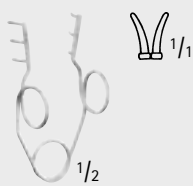

**BV006R**

45 mm, 1 3/4"

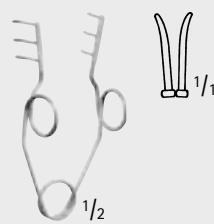

**BV007R**

55 mm, 2 1/4"

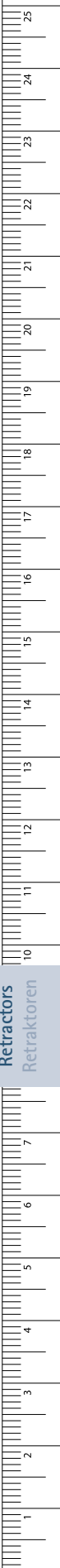

# Retractors, Hooks – Retraktoren, Wundhaken

## Self-Retaining Retractors

### Wundspreizer



ALLPORT

**BV028R**

95 mm, 3 3/4"



JANSEN

**BV030R**

100 mm, 4"

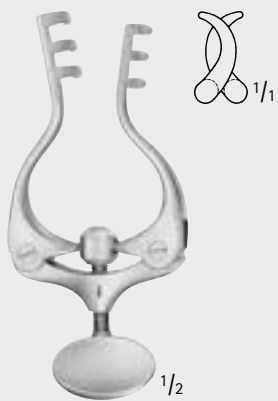

JANSEN

**BV032R**

100 mm, 4"

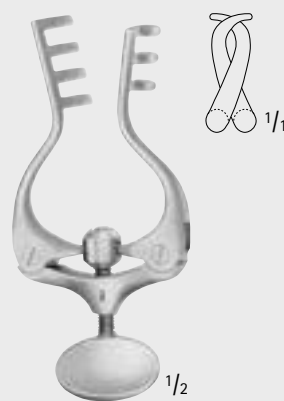

JANSEN

**BV033R**

100 mm, 4"

Retractors  
Retraktoren

# Retractors, Hooks – Retraktoren, Wundhaken

## Self-Retaining Retractors

### Wundspreizer

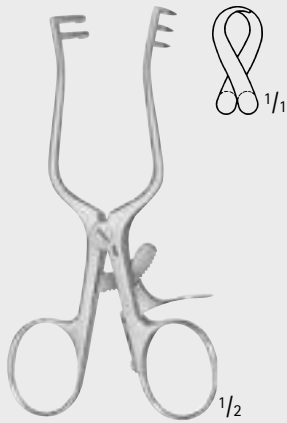

WEITLANER

**BV070R**

sharp

scharf

110 mm, 4 1/4"

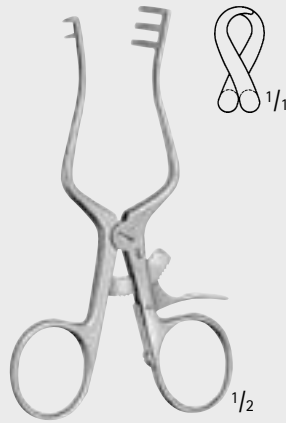

WEITLANER

**BV066R**

semi-sharp

halbscharf

110 mm, 4 1/4"

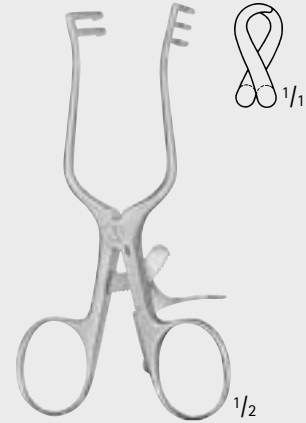

WEITLANER

**BV073R**

blunt

stumpf

110 mm, 4 1/4"

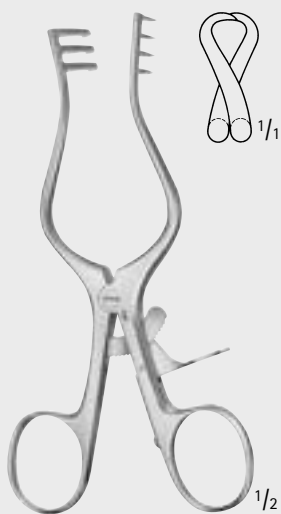

WEITLANER

**BV071R**

sharp

scharf

130 mm, 5 1/8"

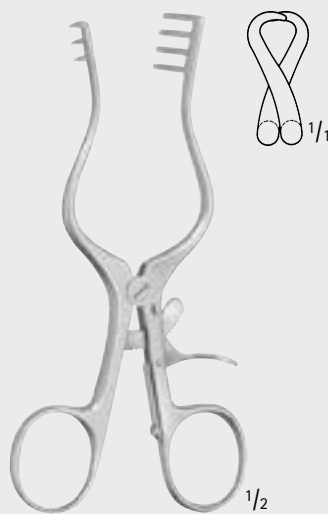

WEITLANER

**BV067R**

semi-sharp

halbscharf

130 mm, 5 1/8"

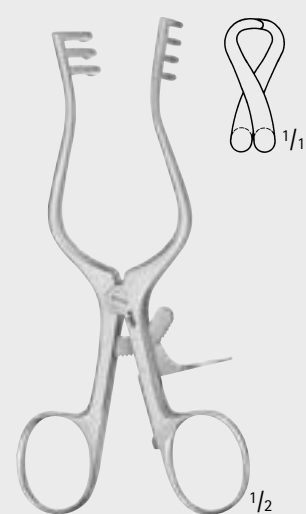

WEITLANER

**BV074R**

blunt

stumpf

130 mm, 5 1/8"

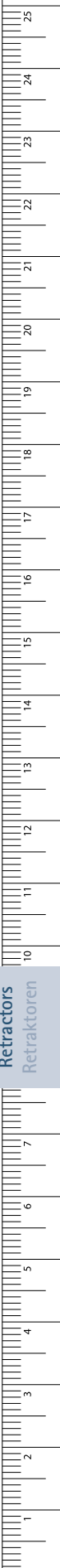

# Retractors, Hooks – Retraktoren, Wundhaken

## Self-Retaining Retractors

### Wundspreizer

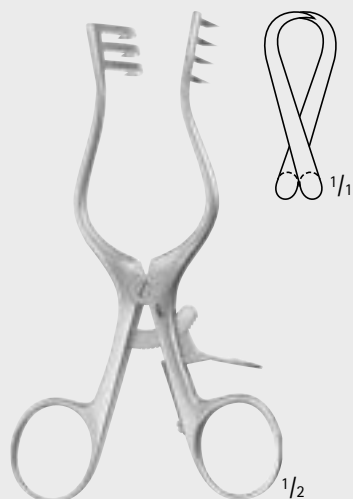
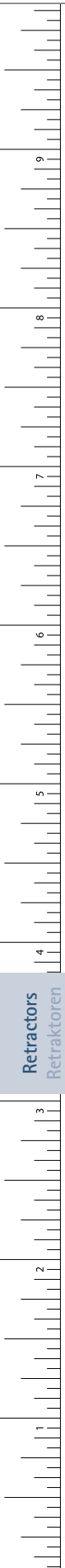

**WEITLANER**  
**BV101R**  
sharp  
scharf  
130 mm, 5 1/8"

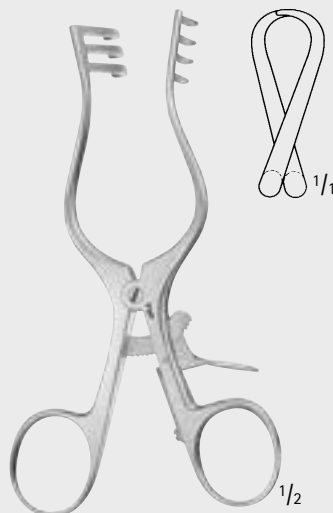

**WEITLANER**  
**BV104R**  
blunt  
stumpf  
130 mm, 5 1/8"

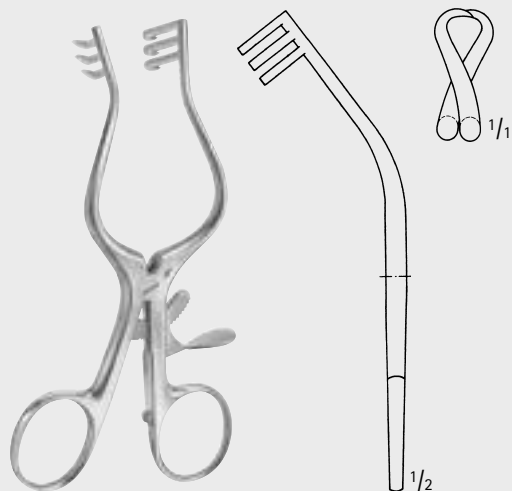

**WULLSTEIN**  
**BV076R**  
sharp  
scharf  
125 mm, 5"

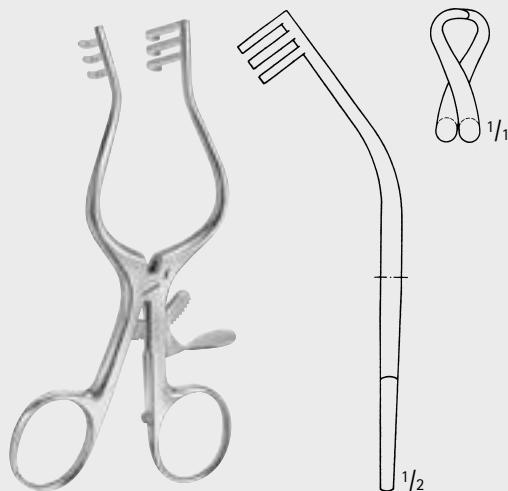

**WULLSTEIN**  
**BV077R**  
blunt  
stumpf  
125 mm, 5"

# Retractors, Hooks – Retraktoren, Wundhaken

## Self-Retaining Retractors

### Wundspreizer

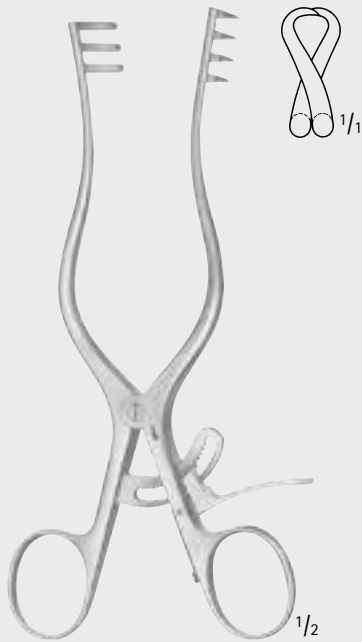

**WEITLANER**  
**BV072R**  
 sharp  
 scharf  
 165 mm, 6 1/2"

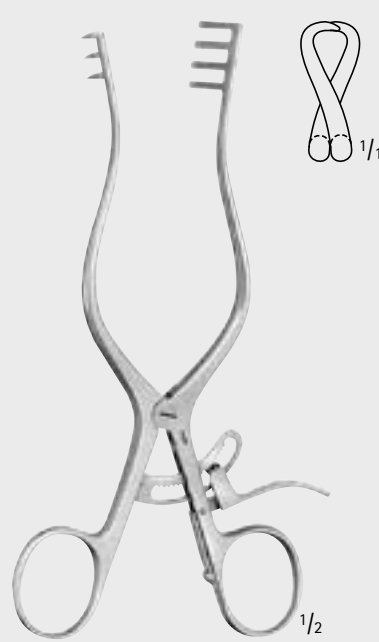

**WEITLANER**  
**BV068R**  
 semi-sharp  
 halbscharf  
 165 mm, 6 1/2"



**WEITLANER**  
**BV075R**  
 blunt  
 stumpf  
 165 mm, 6 1/2"



**ALLENBERG**  
**BV097R**  
 Carotid retractor complete,  
 consisting of:  
 BV098R Retractor only, blunt,  
 170 mm, 6 3/4"  
 BV099R Center blade only,  
 130 mm, 5 1/8"  
 Carotis-Sperrer komplett,  
 bestehend aus:  
 BV098R Sperrer allein, stumpf,  
 170 mm, 6 3/4"  
 BV099R Mittelblatt allein,  
 130 mm, 5 1/8"

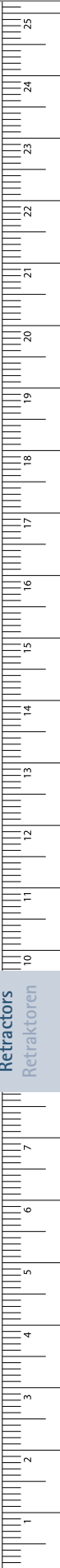

## Retractors, Hooks – Retraktoren, Wundhaken

### Self-Retaining Retractors

#### Wundspreizer

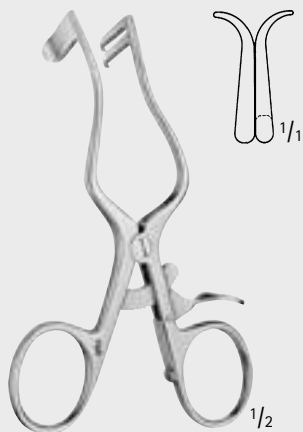
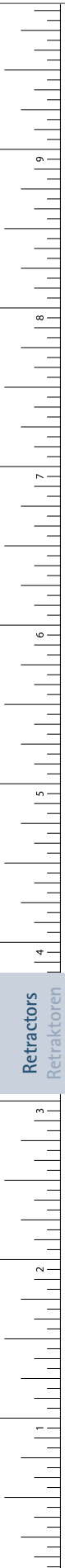

PLESTER

**BV090R**

blunt

stumpf

110 mm, 4 1/4"

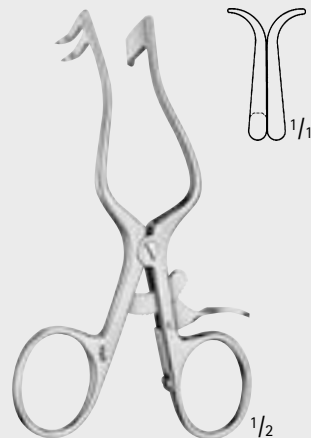

PLESTER

**BV091R**

blunt

stumpf

110 mm, 4 1/4"

Retractors  
Retraktoren

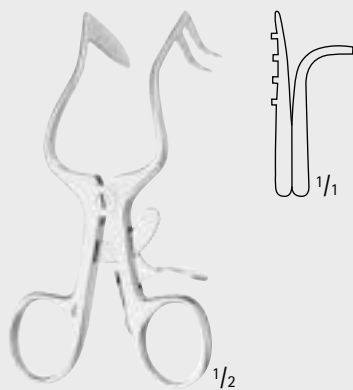

PLESTER-HELMS

Art. No. Art. Nr.	Tip Arbeitsende	Length Länge
<b>BV105R</b>	sharp, right retractor blade full scharf, rechtes Blatt voll	110 mm, 4 1/4"
<b>BV106R</b>	sharp, left retractor blade full scharf, linkes Blatt voll	110 mm, 4 1/4"

# Retractors, Hooks – Retraktoren, Wundhaken

## Self-Retaining Retractors

### Wundspreizer

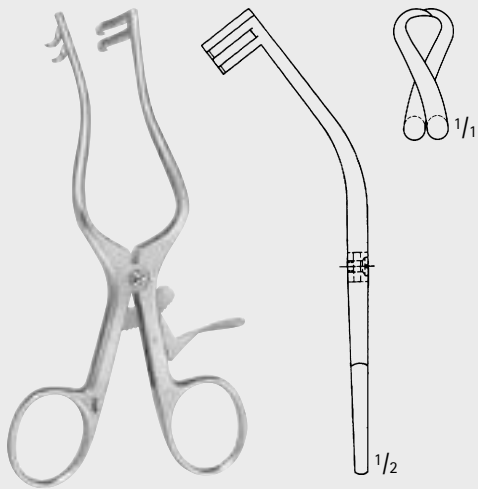

PLESTER

**BV078R**

sharp

scharf

130 mm, 5 1/8"

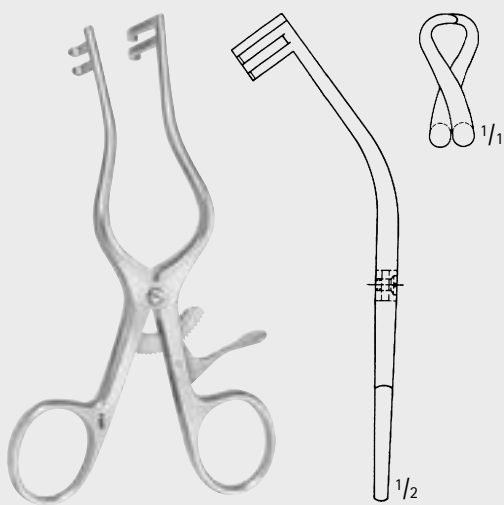

PLESTER

**BV079R**

blunt

stumpf

130 mm, 5 1/8"

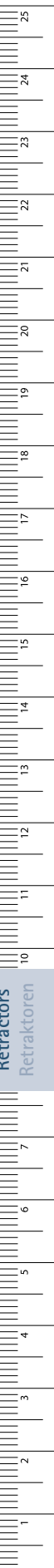

## Retractors, Hooks – Retraktoren, Wundhaken

### Self-Retaining Retractors

#### Wundspreizer

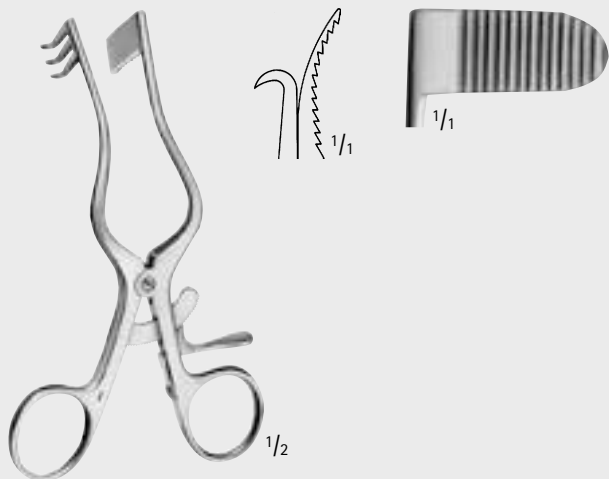
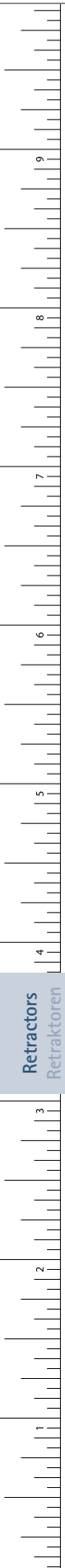

PERKINS

**OK794R**

125 mm, 5"

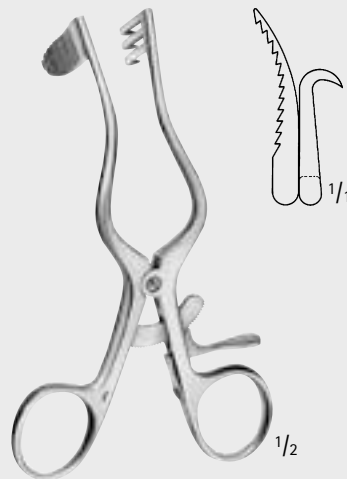

PERKINS

**OK795R**

125 mm, 5"



RNTNE HOSPITAL

**BV084R**

sharp

scharf

165 mm, 6 1/2"



ADSON-BABY

Art. No.	Tip	Length
Art. Nr.	Arbeitsende	Länge
<b>BV085R</b>	semi-sharp halbscharf	140 mm, 5 1/2"
<b>BV094R</b>	semi-sharp halbscharf	165 mm, 6 1/2"



# Retractors, Hooks – Retraktoren, Wundhaken

## Self-Retaining Retractor

### Wundspreizer

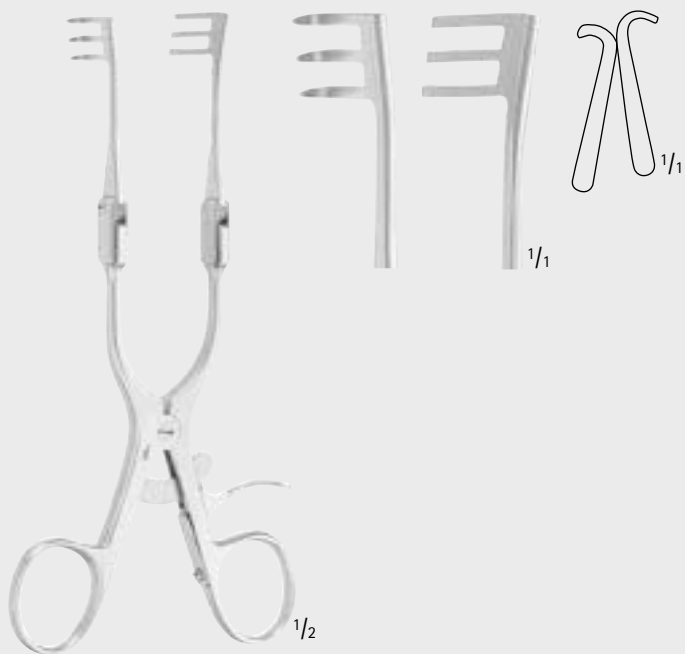

**BV243R**

semi-sharp

halbscharf

170 mm, 6 3/4"

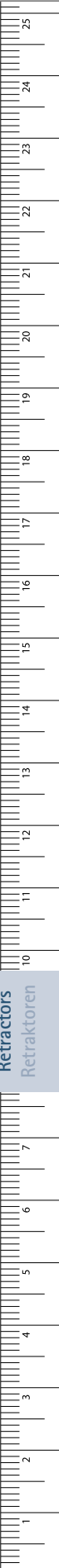

Retractors  
Retraktoren

# Retractors, Hooks – Retraktoren, Wundhaken

## Self-Retaining Retractors

### Wundspreizer

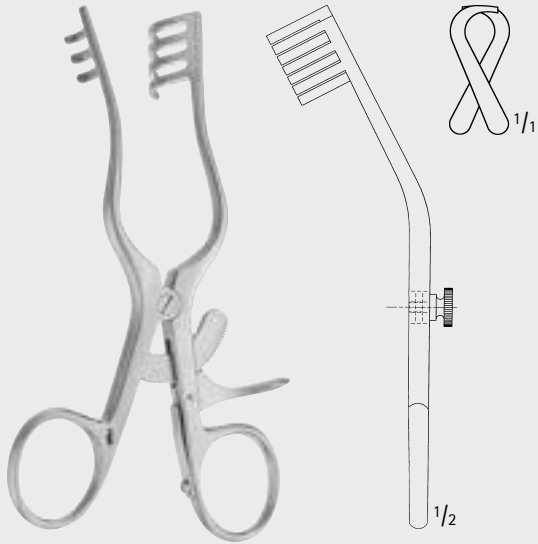

JEFFERSON

**BV092R**

curved, blunt  
gebogen, stumpf  
140 mm, 5 1/2"



MOLLISON

**BV093R**

sharp  
scharf  
140 mm, 5 1/2"

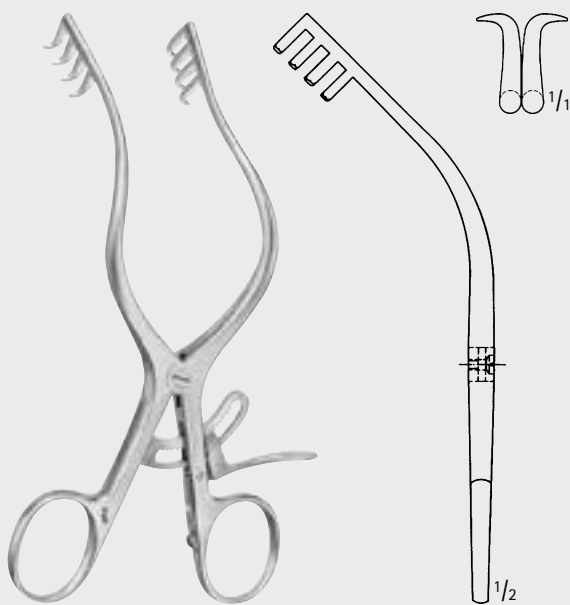

MOLLISON

**BV088R**

sharp  
scharf  
155 mm, 6 1/8"

Retractors  
Retraktoren

INCHES

# Retractors, Hooks – Retraktoren, Wundhaken

## Self-Retaining Retractors

### Wundspreizer



GELPI

**BV996R**

135 mm, 5 1/4"

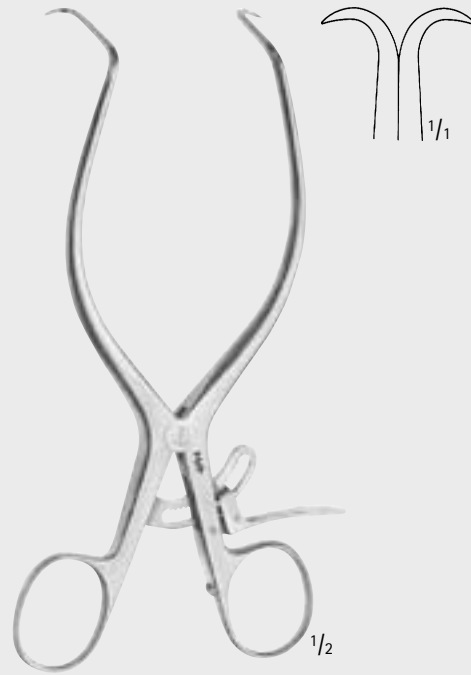

GELPI

**BV997R**

175 mm, 6 7/8"

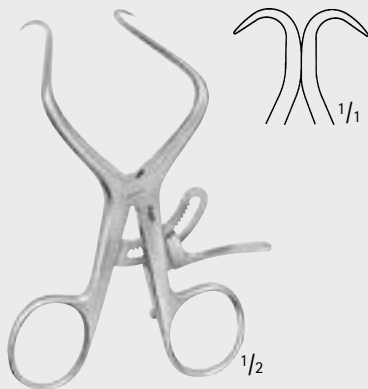

DE BAKEY

**BV998R**

100 mm, 4"

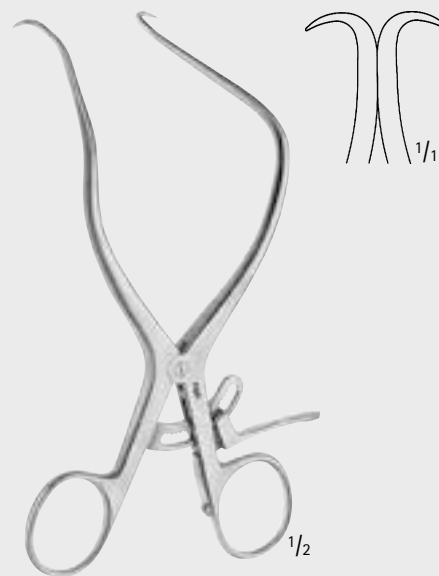

DE BAKEY

**BV999R**

145 mm, 5 1/2"

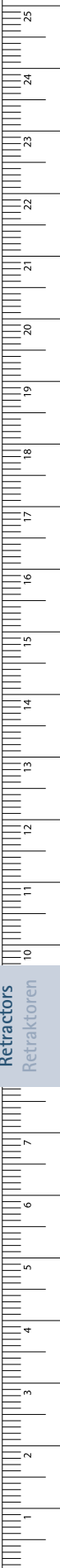

## Retractors, Hooks – Retraktoren, Wundhaken

### Glomus Spreader

### Glomus Spreizer

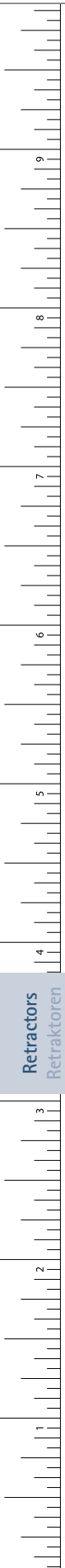

Retractors  
Retraktoren

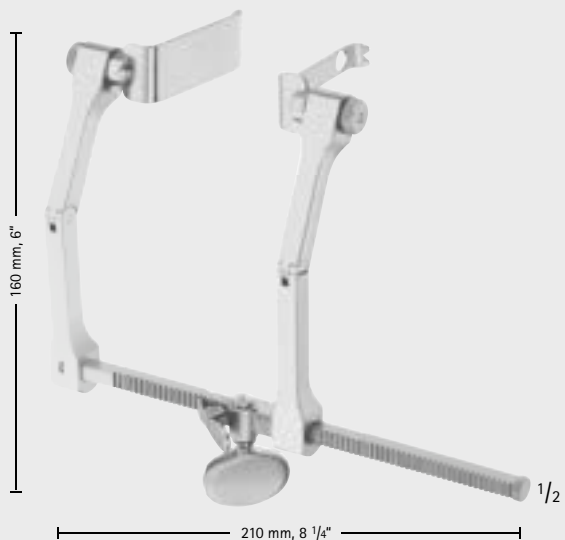

**BV427R**

- Glomus-Spreader complete,  
consisting of:
- BV428R Spreader, only
  - BV432R short blade
  - BV433R long and slim blade with hole
  - BV434R long blade
- Glomus-Spreizer komplett,  
bestehend aus:
- BV428R Spreizer, allein
  - BV432R kurzes Blatt
  - BV433R langes, schmales Blatt mit Loch
  - BV434R langes Blatt



**BV432R**

23.5 x 2 mm



**BV433R**

66 x 14 mm



**BV434R**

64 x 25 mm

# Retractors, Hooks – Retraktoren, Wundhaken

## Thyroid Retractors

### Strumaspreizer

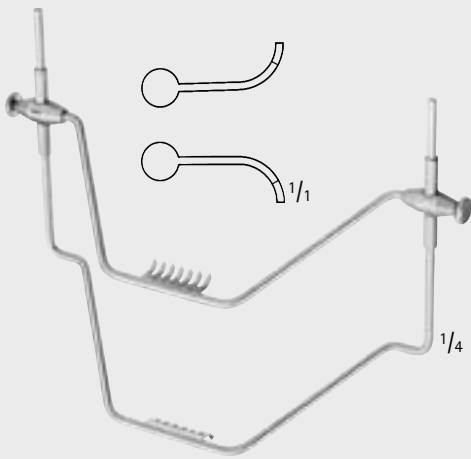

**BV086R**

Thyroid retractor  
Strumaspreizer



JOLL (FRIEDMANN)

**BV087R**

Thyroid retractor  
Strumaspreizer  
155 mm, 6 1/8"

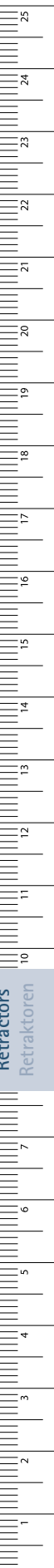

Retractors  
Retraktoren

MILLIMETERS

# Retractors, Hooks – Retraktoren, Wundhaken

## Thyroid Frame

### Strumarahmen

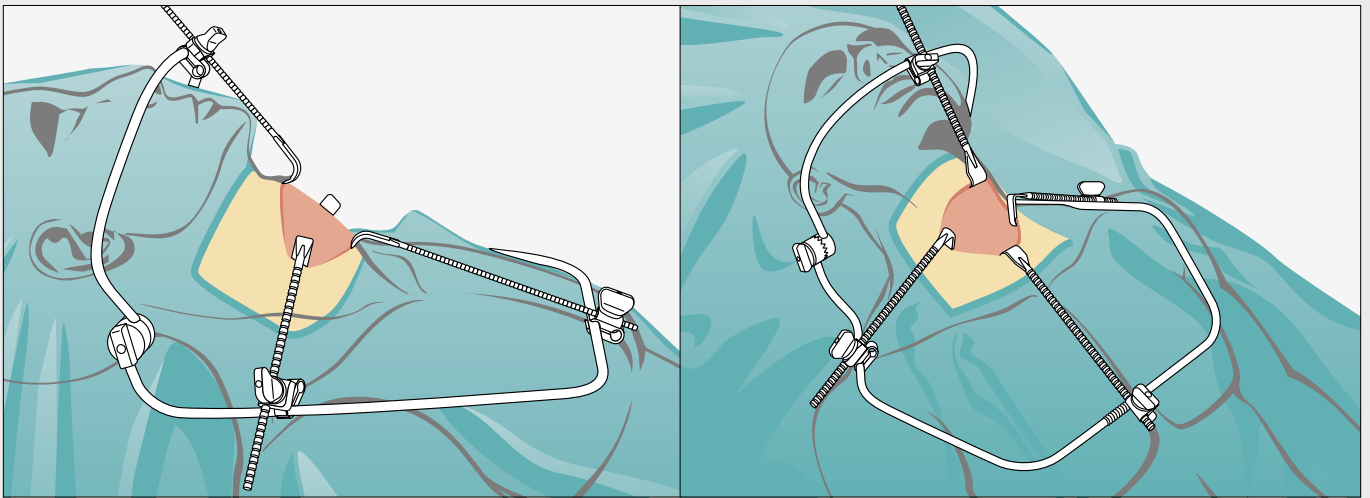

Retractors  
Retraktoren

INCHES

# Retractors, Hooks – Retraktoren, Wundhaken

## Thyroid Frame Strumarahmen

- Parts of the system
- System-Bestandteile



**BW081R**

Fixation clamp  
Befestigungsklemme



**BW080R**

Thyroid frame, detachable  
for storage in Aesculap  
Steril Container,  
see brochure C40402  
Strumarahmen, zerlegbar  
zur Lagerung im Aesculap  
Sterilcontainer,  
siehe Prospekt C40401

### Dimension for the size of retractors

- Blade size Example: 14 x 17 mm  
1st number = depth  
2nd number = width
- Rod length Example: 210 mm, 8 1/4"

### Maßangaben für die Wundhaken

- Blattgrößen Beispiel: 14 x 17 mm  
1. Zahl = Tiefe  
2. Zahl = Breite
- Stangenlänge Beispiel: 210 mm, 8 1/4"



**BW085R**

14 x 17 mm  
210 mm, 8 1/4"



**BW086R**

17 x 16 mm  
210 mm, 8 1/4"



**BW087R**

18 x 22 mm  
210 mm, 8 1/4"



**BW088R**

30 x 19 mm  
210 mm, 8 1/4"



**BW090R**

30 x 20 mm  
145 mm, 5 3/4"



**BW091R**

30 x 40 mm  
120 mm, 4 3/4"



**BW092R**

35 x 11 mm  
210 mm, 8 1/4"



**BW093R**

55 x 20 mm  
145 mm, 5 3/4"



**BW094R**

51 x 30 mm  
120 mm, 4 3/4"

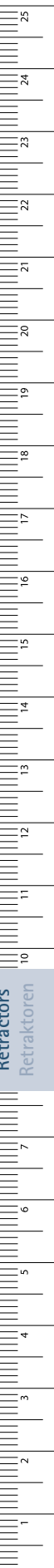

Retractors  
Retraktoren

MILLIMETERS

# Retractors, Hooks – Retraktoren, Wundhaken

## Nerve- and Vessel Hooks

### Nerv- und Gefäßhäkchen

**Dimensions for blade size of retractors**

- 1st number = depth Example: 25 x 38 mm
- 2nd number = width

**Maßangaben für Blattgrößen der Wundhaken**

- 1. Zahl = Tiefe Beispiel: 25 x 38 mm
- 2. Zahl = Breite

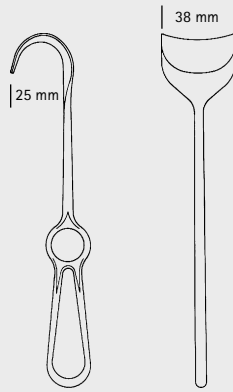

Retractors  
Retraktoren

OF282R OF283R OF284R OF285R 1/1

1/2

**WAGENER**  
**OF282R-OF285R**  
150 mm, 6"

OA357R OA358R OA359R 1/1

1/2

**GRAEFE**  
**OA357R-OA359R**  
140 mm, 5 1/2"

1/1

1/2

**ST. BARTS**  
**OF288R**  
Ear hook, blunt  
Ohrhäkchen, stumpf  
180 mm, 7"



# Retractors, Hooks – Retraktoren, Wundhaken

## Nerve- and Vessel Hooks

## Nerv- und Gefäßhäkchen

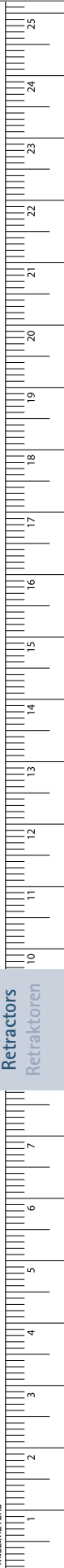

# Retractors, Hooks – Retraktoren, Wundhaken

## Nerve- and Vessel Hooks

### Nerv- und Gefäßhäkchen

#### Dimensions for blade size of retractors

- 1st number = depth Example: 25 x 38 mm
- 2nd number = width

#### Maßangaben für Blattgrößen der Wundhaken

- 1. Zahl = Tiefe Beispiel: 25 x 38 mm
- 2. Zahl = Breite

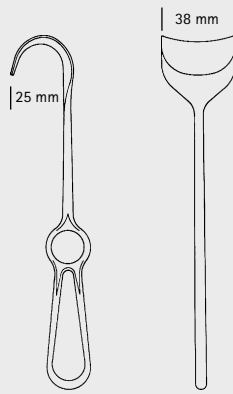

Retractors  
Retraktoren

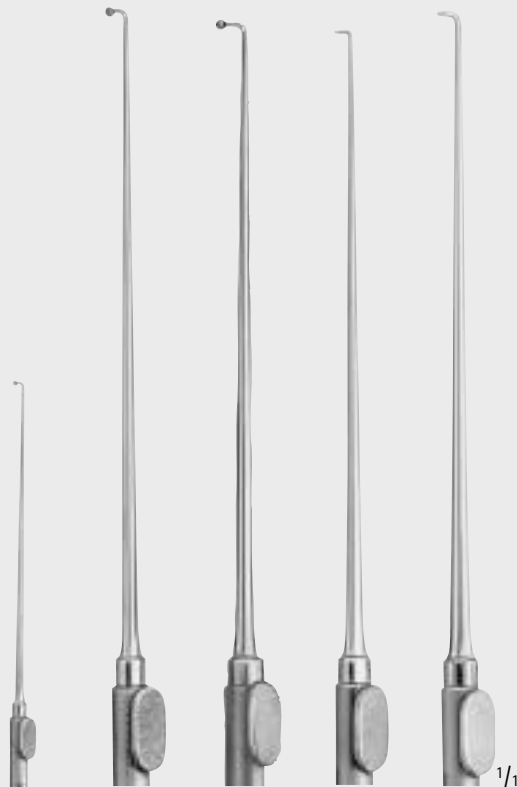

**FD396R**   **FD397R**   **FD398R**   **FD399R** <sup>1/1</sup>

<sup>1/2</sup>

**KRAYENBÜHL**

**FD396R-FD399R**

185 mm, 7 1/4"

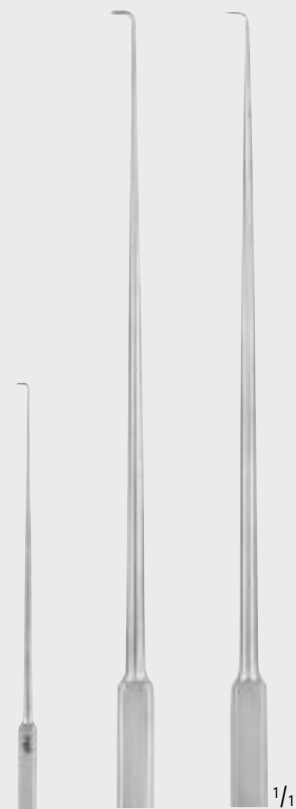

**FD394R**   **FD395R** <sup>1/1</sup>

blunt  
stumpf

sharp  
scharf

<sup>1/2</sup>

**ADSON**

**FD394R-FD395R**

190 mm, 7 1/2"

## Retractors, Hooks – Retraktoren, Wundhaken

### Nerve- and Vessel Hooks

### Nerv- und Gefäßhäkchen

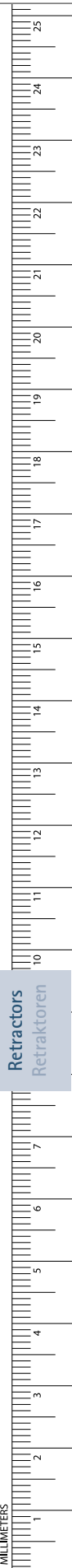

# Retractors, Hooks – Retraktoren, Wundhaken

## Fine Retractors (Dura- and Skin Retractors)

### Feine Wundhäkchen (Dura- und Hauthäkchen)

**Dimensions for blade size of retractors**

- 1st number = depth Example: 25 x 38 mm
- 2nd number = width

**Maßangaben für Blattgrößen der Wundhaken**

- 1. Zahl = Tiefe Beispiel: 25 x 38 mm
- 2. Zahl = Breite

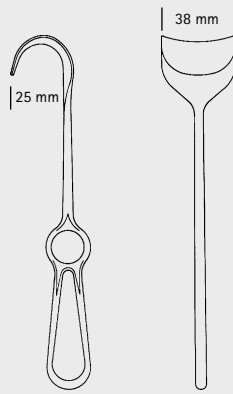

**OA332R**  
sharp  
spitz

**OA333R**  
blunt  
stumpf

**GRAEFE**  
**OA332R-OA333R**  
125 mm, 5"

**OA334R**  
1.2 x 2.0 mm  
125 mm, 5"

**OA335R**  
1.7 x 3.0 mm  
130 mm, 5 1/8"

**GUTHRIE**  
**OA334R-OA335R**  
sharp  
spitz

**OA336R**  
sharp/spitz  
2.2 x 4.5 mm  
130 mm, 5 1/8"

**OA337R**  
sharp/spitz  
2.5 x 7.0 mm  
135 mm, 5 1/4"

**OA338R**  
blunt/stumpf  
2.2 x 7.0 mm  
135 mm, 5 1/4"

**ROLLET**  
**OA336R-OA338R**

**FF313R**  
Dura retractor  
Durahäkchen  
130 mm, 5 1/8"

**FF321R**  
Dura retractor  
Durahäkchen  
130 mm, 5 1/8"

**FF322R**  
Dura retractor  
Durahäkchen  
150 mm, 6"

Retractors  
Retraktoren

INCHES

## Retractors, Hooks – Retraktoren, Wundhaken

### Fine Retractors (Dura- and Skin Retractors)

### Feine Wundhäkchen (Dura- und Hauthäkchen)

$\frac{1}{2}$

$\frac{1}{1}$

$\frac{1}{1}$

**KILNER**  
**OL610R**  
160 mm, 6  $\frac{1}{4}$ "

9 mm

10 mm

$\frac{1}{1}$

$\frac{1}{1}$

$\frac{1}{1}$

$\frac{1}{1}$

**OL615R**      **OL616R**

$\frac{1}{2}$

**MC INDOE**  
**OL615R-OL616R**  
150 mm, 6"

$\frac{1}{1}$

$\frac{1}{1}$

$\frac{1}{1}$

2 x 3.2 mm

$\frac{1}{2}$

**FREER**  
**OL621R**  
150 mm, 6"

$\frac{1}{1}$

$\frac{1}{1}$

$\frac{1}{1}$

$\frac{1}{2}$

**MÜLLER**  
**OL626R**  
150 mm, 6"

$\frac{1}{1}$

$\frac{1}{1}$

$\frac{1}{1}$

2 x 3.2 mm

$\frac{1}{2}$

**MÜLLER**  
**OL627R**  
150 mm, 6"

$\frac{1}{1}$

$\frac{1}{1}$

$\frac{1}{2}$

**COTTLE**  
**OL617R**  
160 mm, 6  $\frac{1}{4}$ "

$\frac{1}{1}$

$\frac{1}{1}$

$\frac{1}{2}$

**COTTLE**  
**OL619R**  
160 mm, 6  $\frac{1}{4}$ "

$\frac{1}{1}$

$\frac{1}{1}$

$\frac{1}{1}$

$\frac{1}{1}$

**OL601R**      **OL602R**      **OL603R**

$\frac{1}{2}$

**KLEINERT-KUTZ**  
**OL601R-OL603R**  
160 mm, 6  $\frac{1}{4}$ "

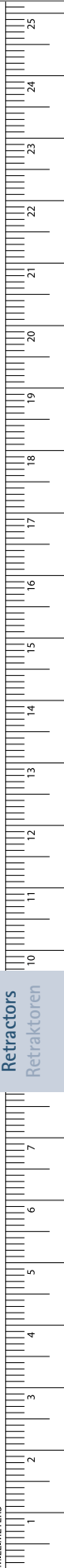

# Retractors, Hooks – Retraktoren, Wundhaken

## Fine Retractors (Dura- and Skin Retractors)

### Feine Wundhäkchen (Dura- und Hauthäkchen)

**Dimensions for blade size of retractors**

- 1st number = depth Example: 25 x 38 mm
- 2nd number = width

**Maßangaben für Blattgrößen der Wundhaken**

- 1. Zahl = Tiefe Beispiel: 25 x 38 mm
- 2. Zahl = Breite

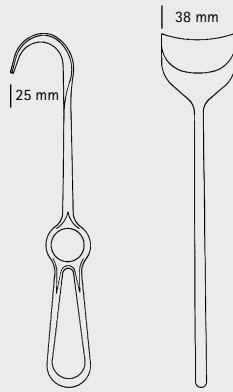

Retractors  
Retraktoren



**JÄGER**  
**OA351R**  
135 mm, 5 1/4"



**JOSEPH**  
**OL620R-MD581**  
165 mm, 6 1/2"

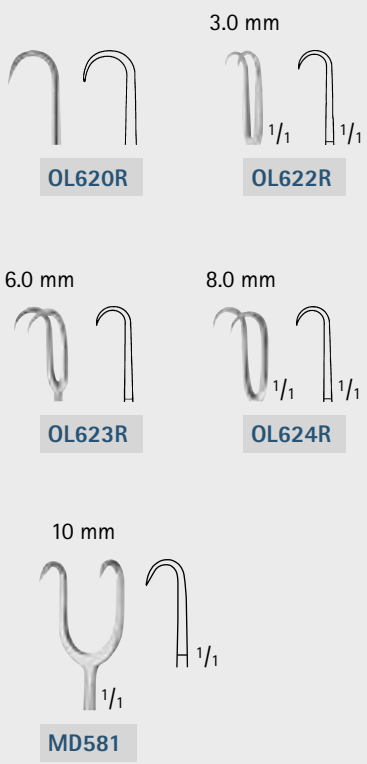

**GILLIES**  
**OL611R-OL612R**  
180 mm, 7"

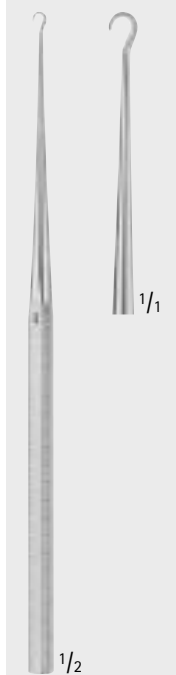

**BT120R**  
175 mm, 6 7/8"

# Retractors, Hooks – Retraktoren, Wundhaken

## Fine Retractors (Dura- and Skin Retractors)

### Feine Wundhäkchen (Dura- und Hauthäkchen)

**BARSKY**  
**OL614R**  
155 mm, 6 1/8"

**FD375R**  
Dura retractor  
Durahäkchen  
185 mm, 7 1/4"

**FISCH**  
**FD376R**  
Dura retractor  
Durahäkchen  
185 mm, 7 1/4"

**KILNER**  
**OL206R**  
sharp  
spitz  
80 mm, 3 1/8"

**CONVERSE**  
**OL207R**  
blunt  
stumpf  
120 mm, 4 3/4"

**FD392R**  
Tissue pick  
Gewebekralle  
185 mm, 7 1/4"

diam. 1.8 mm  
Ø 1,8 mm

Double picks to grasp and lift skin, tissue etc.  
Doppelkrallen zum Fassen und Anheben von Haut, Gewebe etc.

Protector for storing and sterilization  
Schutzhülse zur Lagerung und Sterilisation

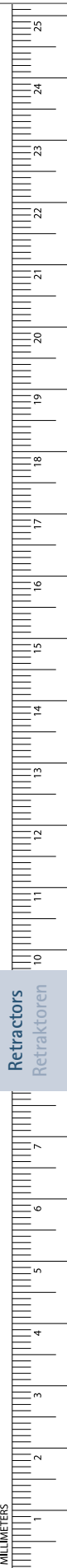

# Retractors, Hooks – Retraktoren, Wundhaken

## Trachea Retractors

### Wund- und Trachealhäkchen

**Dimensions for blade size of retractors**

- 1st number = depth Example: 25 x 38 mm
- 2nd number = width

**Maßangaben für Blattgrößen der Wundhaken**

- 1. Zahl = Tiefe Beispiel: 25 x 38 mm
- 2. Zahl = Breite

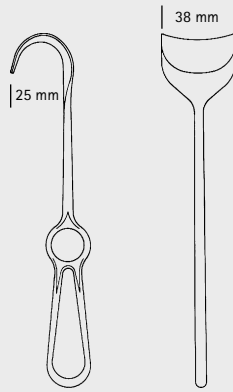

7 mm



**BERGMANN**

**BT100R**

140 mm, 5 1/2"



**BOSE**

**FA025R**

165 mm, 6 1/2"



**BOSE**

**FA026R**

165 mm, 6 1/2"

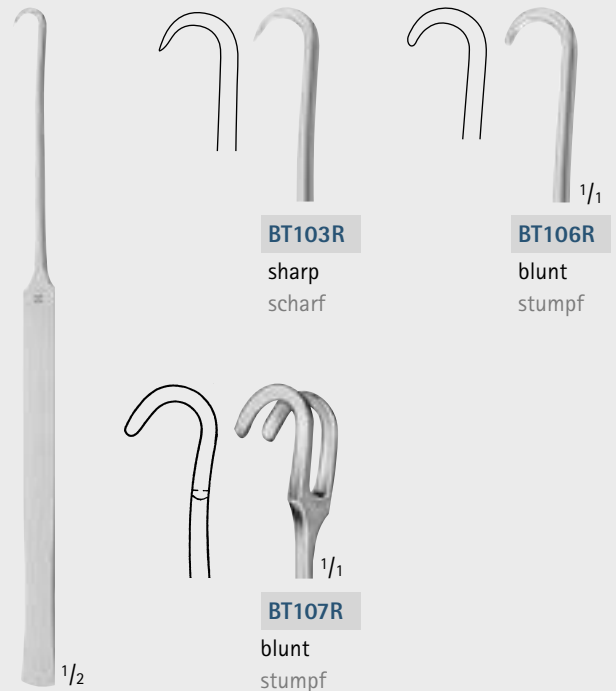

**BT103R**

sharp  
scharf

**BT106R**

blunt  
stumpf

**BT107R**

blunt  
stumpf

**BT103R–BT107R**

180 mm, 7"



# Retractors, Hooks – Retraktoren, Wundhaken

## Trachea Retractors

### Wund- und Trachealhäkchen

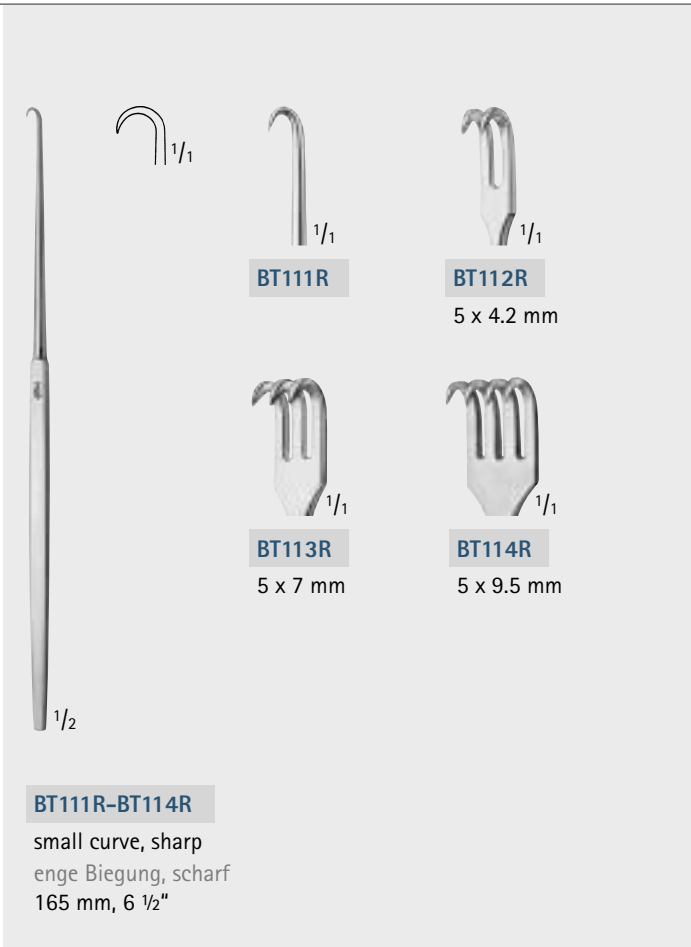

BT111R  
BT112R  
5 x 4.2 mm

BT113R  
5 x 7 mm

BT114R  
5 x 9.5 mm

**BT111R-BT114R**  
small curve, sharp  
enge Biegung, scharf  
165 mm, 6 1/2"

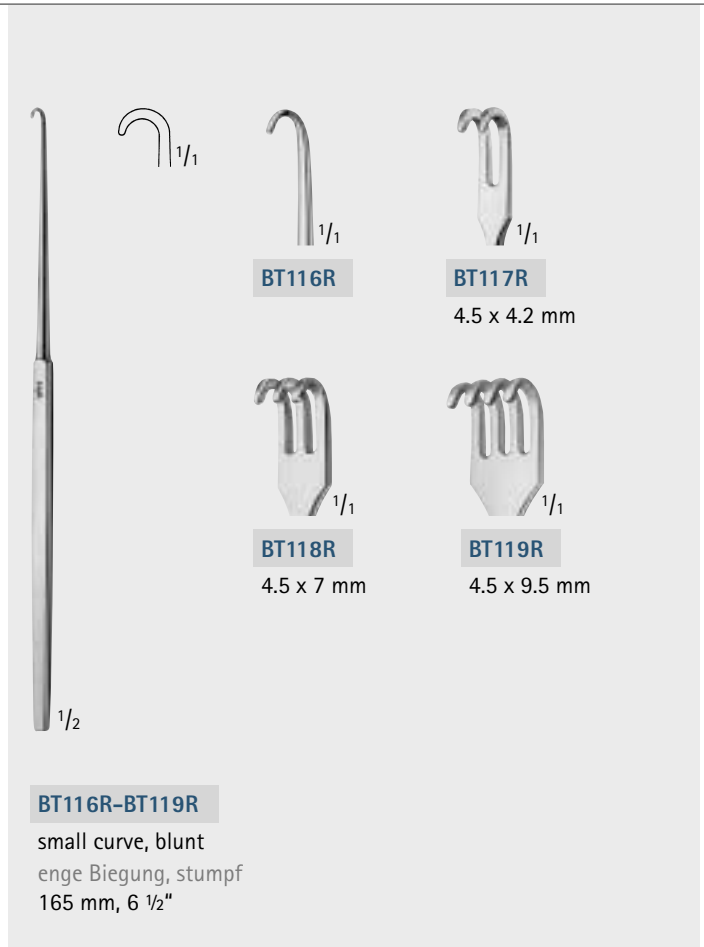

BT116R  
BT117R  
4.5 x 4.2 mm

BT118R  
4.5 x 7 mm

BT119R  
4.5 x 9.5 mm

**BT116R-BT119R**  
small curve, blunt  
enge Biegung, stumpf  
165 mm, 6 1/2"

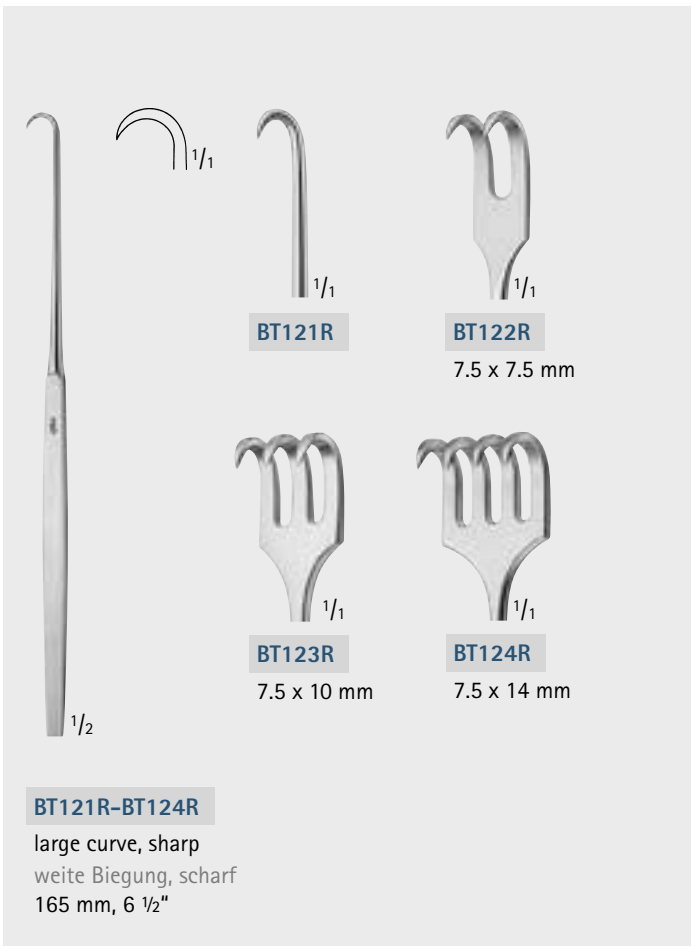

BT121R  
BT122R  
7.5 x 7.5 mm

BT123R  
7.5 x 10 mm

BT124R  
7.5 x 14 mm

**BT121R-BT124R**  
large curve, sharp  
weite Biegung, scharf  
165 mm, 6 1/2"

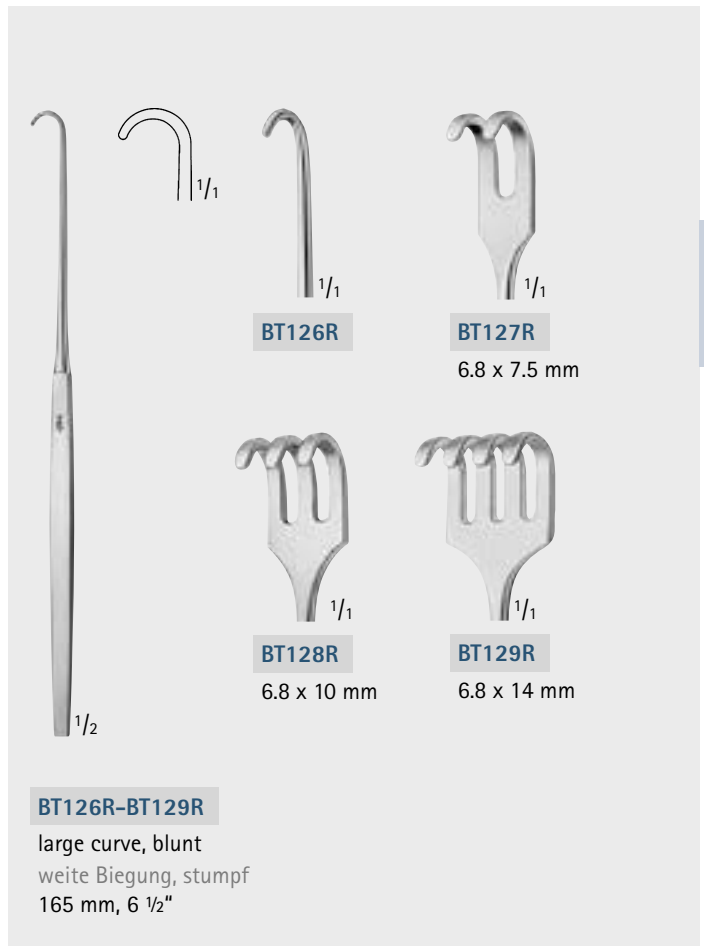

BT126R  
BT127R  
6.8 x 7.5 mm

BT128R  
6.8 x 10 mm

BT129R  
6.8 x 14 mm

**BT126R-BT129R**  
large curve, blunt  
weite Biegung, stumpf  
165 mm, 6 1/2"

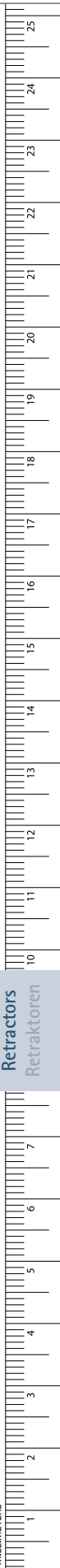

# Retractors, Hooks – Retraktoren, Wundhaken

## Retractors with Treangle Handle

### Wundhaken mit Treangle-Griff

**Dimensions for blade size of retractors**

- 1st number = depth Example: 25 x 38 mm
- 2nd number = width

**Maßangaben für Blattgrößen der Wundhaken**

- 1. Zahl = Tiefe Beispiel: 25 x 38 mm
- 2. Zahl = Breite

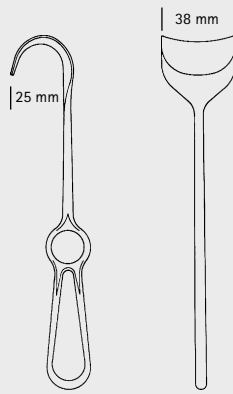

Retractors  
Retraktoren



**MANNERFELT MODIF.**  
**BT901R**  
sharp  
scharf  
135 mm, 5 1/4"



**MANNERFELT MODIF.**  
**BT902R**  
sharp  
scharf  
155 mm, 6 1/8"



**MANNERFELT MODIF.**  
**BT904R**  
hollow grooved  
hohlgekehlt  
155 mm, 6 1/8"

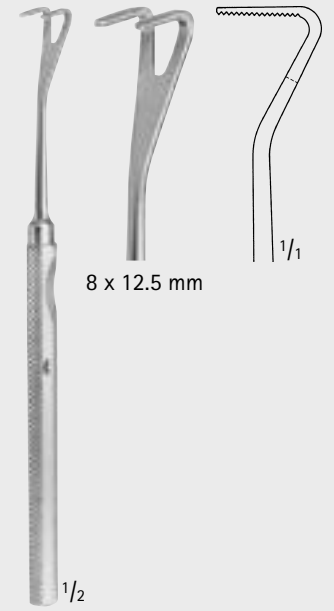

**MANNERFELT MODIF.**  
**BT906R**  
Forked hook, retrograded curved  
Gabelhaken, retrograd gebogen  
155 mm, 6 1/8"

# Retractors, Hooks – Retraktoren, Wundhaken

## Retractors with Treangle Handle

### Wundhaken mit Treangle-Griff

**BT911R**  
1/1

**BT912R**  
1/1  
5 x 4 mm

**BT913R**  
1/1  
5.5 x 7.2 mm

1/2

**MANNERFELT MODIF.**  
**BT911R–BT913R**  
small curve, sharp  
enge Biegung, scharf  
155 mm, 6 1/8"

**BT916R**  
1/1

**BT917R**  
1/1  
5.5 x 4 mm

**BT918R**  
1/1  
5.5 x 7.2 mm

1/2

**MANNERFELT MODIF.**  
**BT916R–BT918R**  
small curve, blunt  
enge Biegung, stumpf  
155 mm, 6 1/8"

**BT921R**  
1/1

**BT922R**  
1/1  
8 x 8 mm

**BT923R**  
1/1  
7 x 11 mm

1/2

**MANNERFELT MODIF.**  
**BT921R–BT923R**  
large curve, sharp  
weite Biegung, scharf  
155 mm, 6 1/8"

**BT926R**  
1/1

**BT927R**  
1/1  
7 x 8 mm

**BT928R**  
1/1  
7 x 11 mm

1/2

**MANNERFELT MODIF.**  
**BT926R–BT928R**  
large curve, blunt  
weite Biegung, stumpf  
155 mm, 6 1/8"

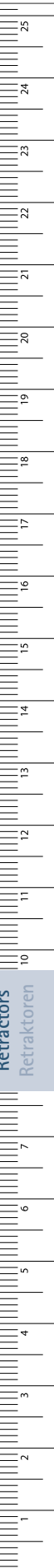

# Retractors, Hooks – Retraktoren, Wundhaken

## Alar Retractors

### Nasenflügelretraktoren

#### Dimensions for blade size of retractors

- 1st number = depth Example: 25 x 38 mm
- 2nd number = width

#### Maßangaben für Blattgrößen der Wundhaken

- 1. Zahl = Tiefe Beispiel: 25 x 38 mm
- 2. Zahl = Breite

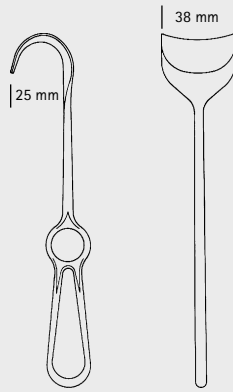

**FOMON**  
**OL202R**  
Alar retractor, 2 prongs, blunt/blunt  
Nasenflügelretractor, 2 zinkig, stumpf/stumpf  
145 mm, 5 3/4"



**COTTLE**  
**OL203R**  
Alar retractor, 2 prongs, blunt/sharp  
Nasenflügelretractor, 2 zinkig, stumpf/spitz  
145 mm, 5 3/4"



**COTTLE**  
**OL204R**  
Alar retractor, 2 prongs, sharp/blunt  
Nasenflügelretractor, 2 zinkig, spitz/stumpf  
145 mm, 5 3/4"



**COTTLE**  
**OL214R**  
Alar retractor, with saw and knife guide, 2 prongs, blunt/blunt  
Nasenflügelretractor, mit Säge- oder Messerführung, 2 zinkig, stumpf/stumpf  
200 mm, 7 7/8"

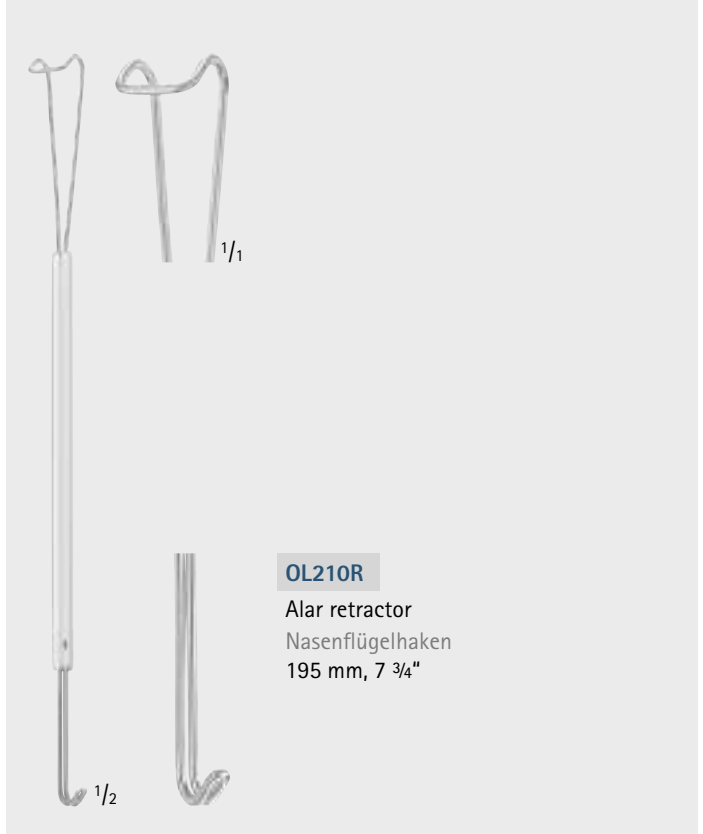

**COTTLE**  
**OL210R**  
Alar retractor  
Nasenflügelhaken  
195 mm, 7 3/4"

Retractors  
Retraktoren

INCHES

# Retractors, Hooks – Retraktoren, Wundhaken

## Retractors with Treangle Handle

### Wundhaken mit Treangle Griff

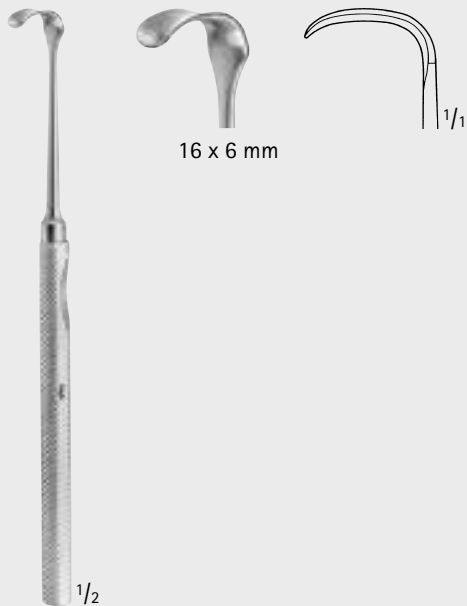

MANNERFELT MODIF.

**BT940R**

hollow grooved

hohlgekehlt

155 mm, 6 1/8"



LANGENBECK-MANNERFELT MODIF.

**BT943R-BT946R**

155 mm, 6 1/8"

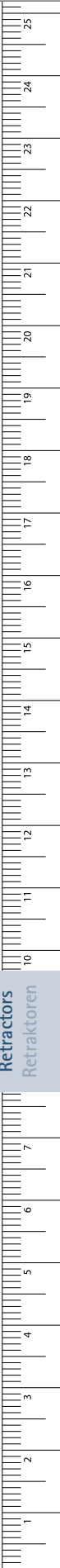

# Retractors, Hooks – Retraktoren, Wundhaken

## Retractors with Treangle Handle

### Wundhaken mit Treangle Griff

**Dimensions for blade size of retractors**

- 1st number = depth Example: 25 x 38 mm
- 2nd number = width

**Maßangaben für Blattgrößen der Wundhaken**

- 1. Zahl = Tiefe Beispiel: 25 x 38 mm
- 2. Zahl = Breite

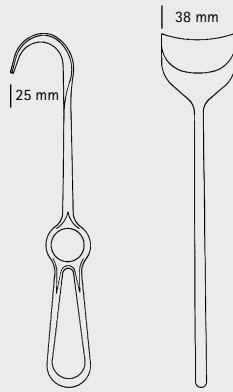

**BT948R**

12 x 12 mm



**BT949R**

12 x 14 mm



**BT951R**

14 x 16 mm

MANNERFELT MODIF.

**BT948R–BT951R**

Saddle hooks

Sattelhaken

155 mm, 6 1/8"



12 x 12 mm

1/2

MANNERFELT MODIF.

**BT958R**

Saddle hooks, fenestrated

Sattelhaken, gefenstert

155 mm, 6 1/8"

Retractors  
Retraktoren

INCHES

# Retractors, Hooks – Retraktoren, Wundhaken

## Retractors Wundhaken

**BT173R**  
1/1

**BT174R**  
1/1

**BT173R-BT174R**  
160 mm, 6 1/4"

**BT177R**  
16 x 6 mm  
1/1

**BT178R**  
24 x 6 mm  
1/1

**LANGENBECK-GREEN**  
**BT177R-BT178R**  
160 mm, 6 1/4"

**BT179R**  
10 x 13 mm  
1/1

**BT179R**  
160 mm, 6 1/4"

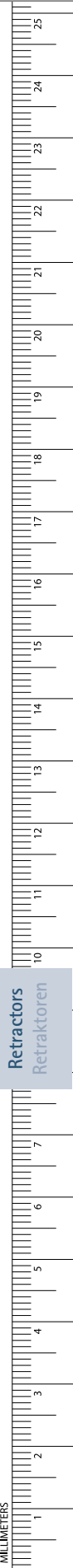

# Retractors, Hooks – Retraktoren, Wundhaken

## Retractors

### Wundhaken

#### Dimensions for blade size of retractors

- 1st number = depth Example: 25 x 38 mm
- 2nd number = width

#### Maßangaben für Blattgrößen der Wundhaken

- 1. Zahl = Tiefe Beispiel: 25 x 38 mm
- 2. Zahl = Breite

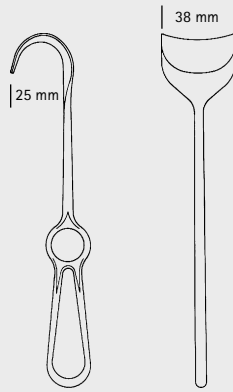

**BT193R**

Fig. A  
18 x 7 mm



**BT194R**

Fig. B  
16 x 5 mm



**BT196R**

Fig. D  
5 x 10 mm



**BT197R**

Fig. E  
11 x 4 mm



**BT198R**

Fig. F  
6 x 4 mm



**BT195R**

Fig. C  
7 x 4 mm



1/2

**MEYERDING**

**BT193R–BT198R**

180 mm, 7"

Retractors  
Retraktoren

INCHES



# Retractors, Hooks – Retraktoren, Wundhaken

## Retractors Wundhaken



$\frac{1}{2}$

**EMMET**  
**BT161R**  
Fistula hook  
Fistelhaken  
220 mm, 8  $\frac{3}{4}$ "



$\frac{1}{2}$

**SIMON**  
**BT166R**  
Fistula hook  
Fistelhaken  
220 mm, 8  $\frac{3}{4}$ "



$\frac{1}{2}$

**SIMON**  
**BT167R**  
Fistula hook  
Fistelhaken  
220 mm, 8  $\frac{3}{4}$ "



$\frac{1}{2}$

**LANGE**  
**OL201R**  
Fistula hook  
Fistelhaken  
235 mm, 9  $\frac{1}{4}$ "

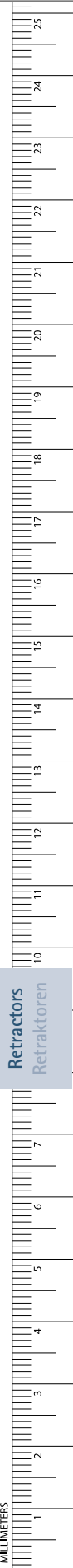

# Retractors, Hooks – Retraktoren, Wundhaken

## Retractors

### Wundhaken

#### Dimensions for blade size of retractors

- 1st number = depth Example: 25 x 38 mm
- 2nd number = width

#### Maßangaben für Blattgrößen der Wundhaken

- 1. Zahl = Tiefe Beispiel: 25 x 38 mm
- 2. Zahl = Breite

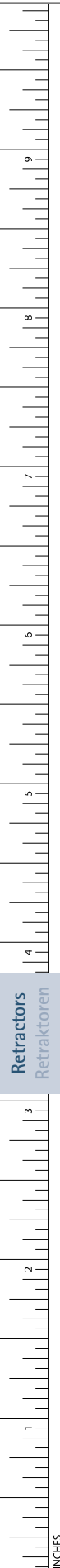
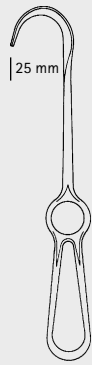

Retractors  
Retraktoren

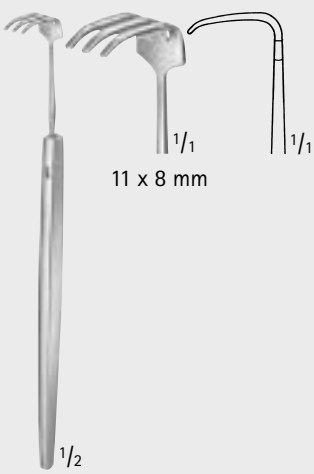

PAUL

**OA340R**

Tendon hook  
Sehnenscheidenhaken  
120 mm, 4 3/4"

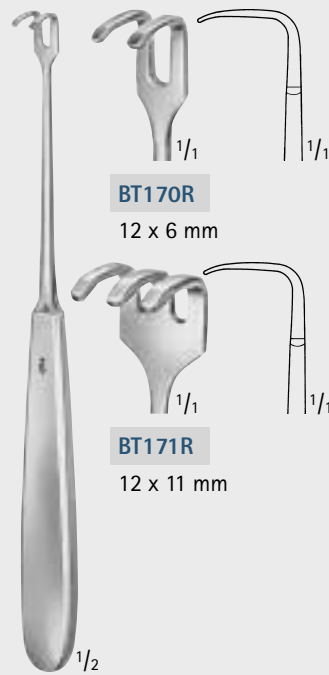

**BT170R**

12 x 6 mm

**BT171R**

12 x 11 mm

**BT170R-BT171R**

Tendon hook  
Sehnenscheidenhaken  
175 mm, 6 7/8"

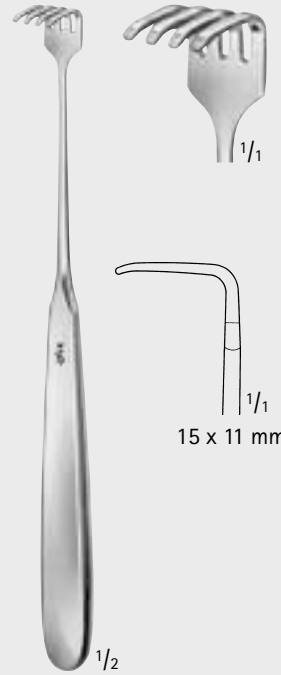

KLAPP

**BT172R**

Tendon hook  
Sehnenscheidenhaken  
175 mm, 6 7/8"

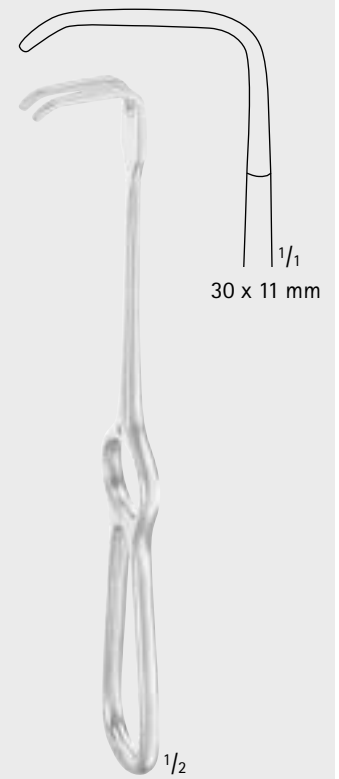

**BT169R**

Parotid hook  
Parotishaken  
185 mm, 7 1/4"

# Retractors, Hooks – Retraktoren, Wundhaken

## Retractors Wundhaken

**MASING**  
**OL211R**  
140 mm, 5 1/2"

6 x 12 mm

1/1

1/2

**COTTLE**  
**OL212R**  
140 mm, 5 1/2"

10 x 12 mm

1/1

1/2

**DESMARRES**  
**OA310R-OA314R**  
140 mm, 5 1/2"

9 x 9 mm

9 x 12 mm

11 x 14 mm

12 x 16 mm

13 x 18 mm

1/1

1/1

1/1

1/1

1/1

1/2

**STRANDELL-STILLE**  
**BT180R-BT181R**  
180 mm, 7"

15 x 6 mm  
blunt  
stumpf

15 x 6 mm  
toothed  
gezahnt

1/1

1/1

1/2

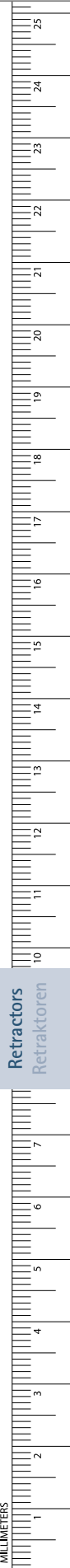

# Retractors, Hooks – Retraktoren, Wundhaken

## Vein Retractors

### Wund- und Venenhaken

#### Dimensions for blade size of retractors

- 1st number = depth Example: 25 x 38 mm
- 2nd number = width

#### Maßangaben für Blattgrößen der Wundhaken

- 1. Zahl = Tiefe Beispiel: 25 x 38 mm
- 2. Zahl = Breite

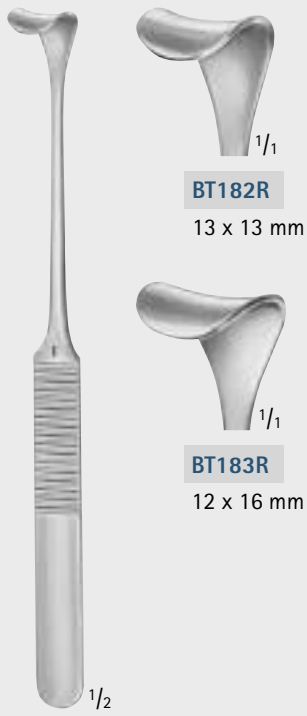
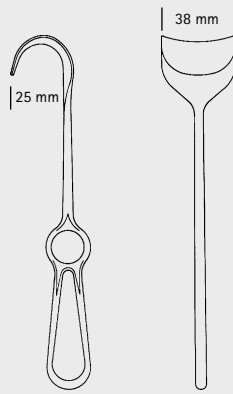

**KÖNIG**  
**BT182R–BT183R**  
 180 mm, 7"



**CUSHING-KOCHER**  
**BT190R**  
 175 mm, 6 7/8"



**KOCHER**  
**BT457R–BT458R**  
 205 mm, 8"

Retractors  
Retraktoren

INCHES

# Retractors, Hooks – Retraktoren, Wundhaken

## Vein Retractors

### Wund- und Venenhaken



13 x 6 mm

<sup>1/2</sup>  
SCHOENBORN  
**BT192R**  
200 mm, 7 7/8"

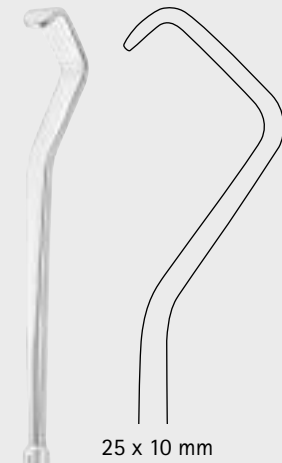

25 x 10 mm

<sup>1/2</sup>  
**BT199R**  
Thyroid hook  
Schilddrüsenhaken  
220 mm, 8 3/4"



10 x 13 mm



14 x 18 mm

<sup>1/2</sup>  
CUSHING  
**BT184R-BT185R**  
205 mm, 8"

20 x 15 mm



<sup>1/2</sup>  
20 x 19 mm  
**BT187R**  
205 mm, 8"

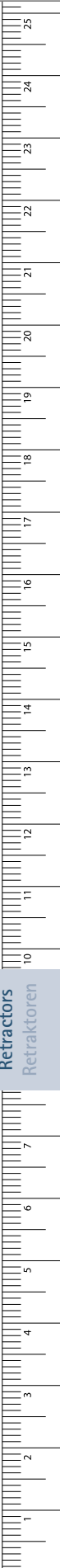

# Retractors, Hooks – Retraktoren, Wundhaken

## Retractors

### Wundhaken

#### Dimensions for blade size of retractors

- 1st number = depth Example: 25 x 38 mm
- 2nd number = width

#### Maßangaben für Blattgrößen der Wundhaken

- 1. Zahl = Tiefe Beispiel: 25 x 38 mm
- 2. Zahl = Breite

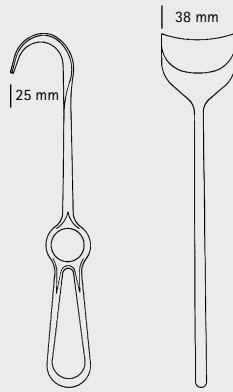

5 x 10 mm

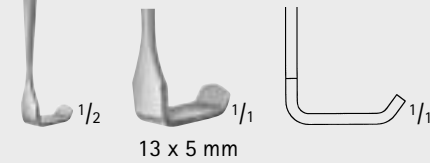

**KILNER**  
**BT005R**  
165 mm, 6 1/2"

Retractors  
Retraktoren

8 x 7 mm

8 x 7 mm

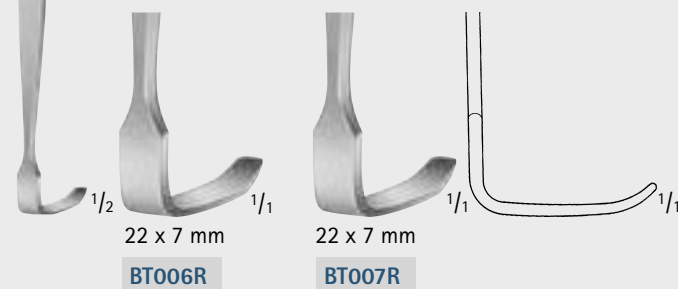
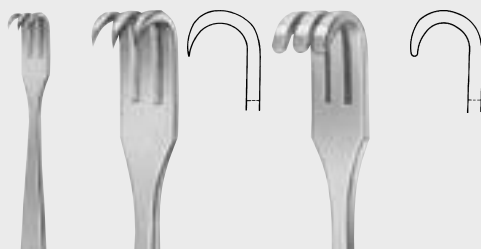

**BT006R**

**BT007R**

**BABY-SENN-MILLER**  
**BT006R-BT007R**  
155 mm, 6 1/8"

8 x 7 mm

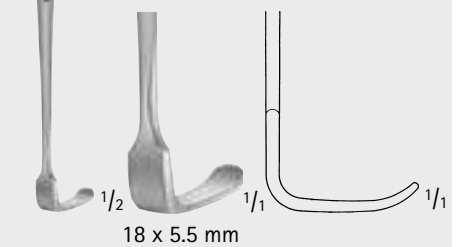

**SENN-MILLER**  
**BT008R**  
165 mm, 6 1/2"

# Retractors, Hooks – Retraktoren, Wundhaken

## Retractors Wundhaken

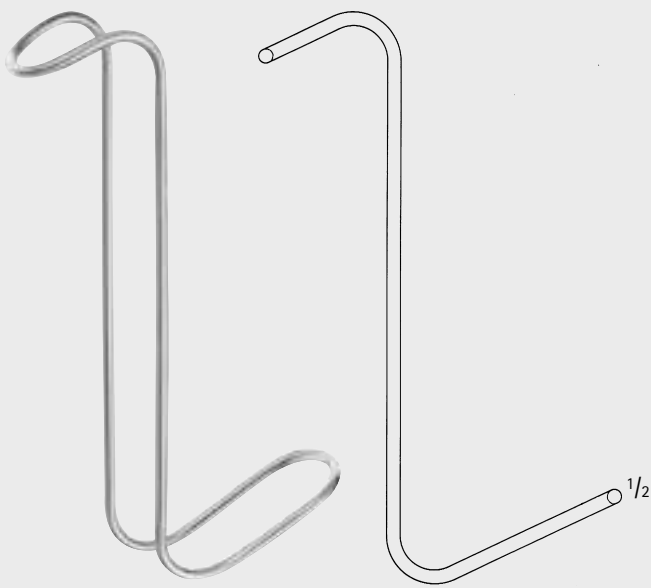

COLLIN-HARTMANN

**BT001R**

150 mm, 6"

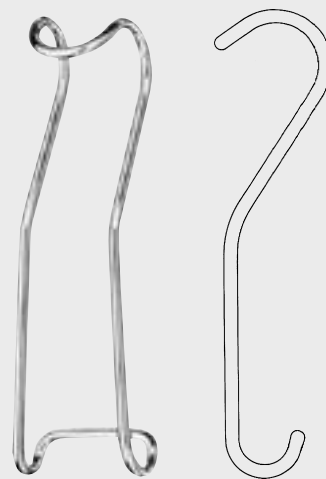

STERNBERG

Art. No.	Length
Art. Nr.	Länge
<b>OM251R</b>	120 mm, 4 3/4"
<b>OM252R</b>	130 mm, 5 1/8"
<b>OM253R</b>	135 mm, 5 1/4"

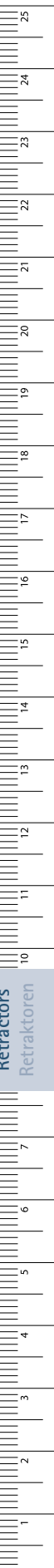

Retractors  
Retraktoren

# Retractors, Hooks – Retraktoren, Wundhaken

## Retractors

### Wundhaken

#### Dimensions for blade size of retractors

- 1st number = depth Example: 25 x 38 mm
- 2nd number = width

#### Maßangaben für Blattgrößen der Wundhaken

- 1. Zahl = Tiefe Beispiel: 25 x 38 mm
- 2. Zahl = Breite

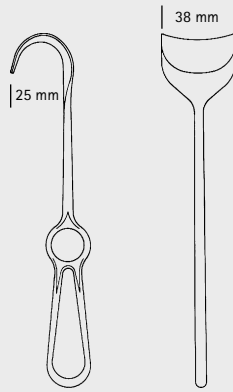

Retractors  
Retraktoren

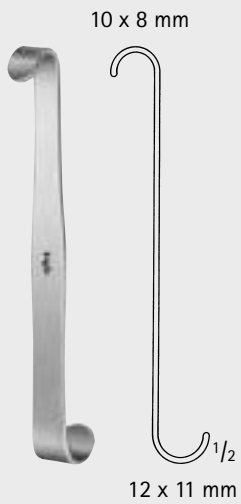

**LUER**  
**BT010R**  
110 mm, 4 1/4"

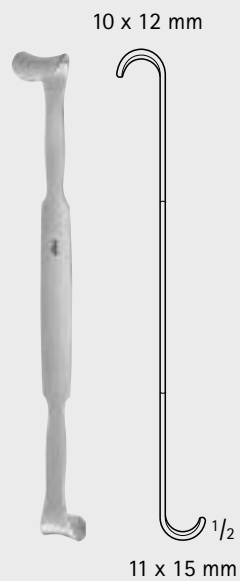

**ROSE**  
**BT011R**  
130 mm, 5 1/8"

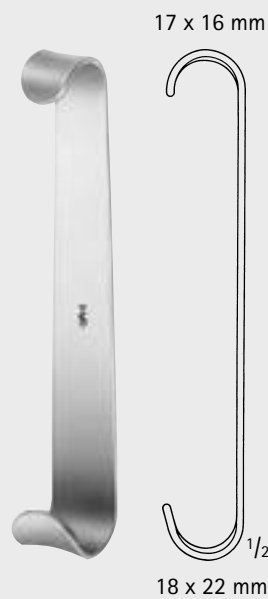

**BABY-ROUX**  
**BT019R**  
135 mm, 5 1/4"

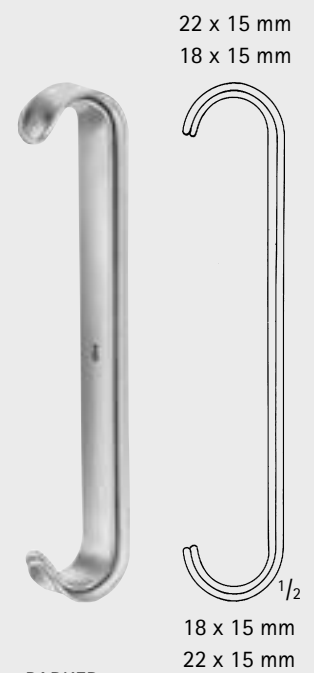

**PARKER**  
**BT025R**  
135 mm, 5 1/4"



# Retractors, Hooks – Retraktoren, Wundhaken

## Retractors Wundhaken



5 x 3 mm

1/1

14 x 6.3 mm

1/2

1/1

**RAGNELL**  
**BT004R**  
150 mm, 6"

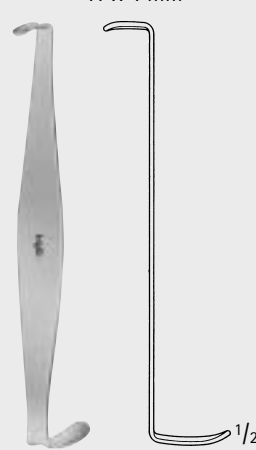

11 x 4 mm

19 x 6 mm

1/2

**CRILE**  
**BT012R**  
110 mm, 4 1/4"

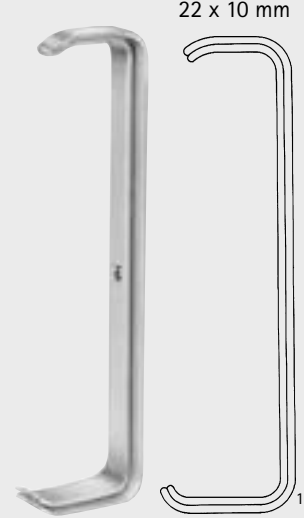

25 x 10 mm  
22 x 10 mm

29 x 12 mm  
32 x 12 mm

1/2

**FARABEUF**  
**BT020R**  
125 mm, 5"

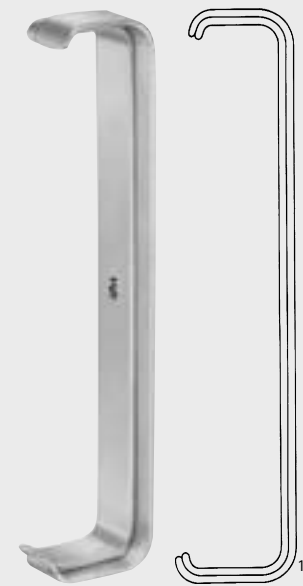

23 x 16 mm  
19 x 16 mm

24 x 16 mm  
28 x 16 mm

1/2

**FARABEUF**  
**BT021R**  
150 mm, 6"

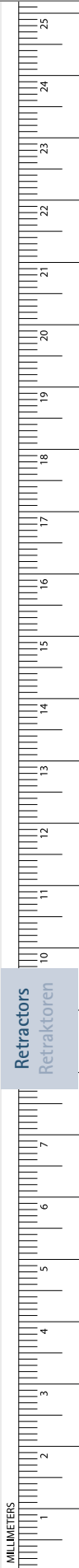

# Retractors, Hooks – Retraktoren, Wundhaken

## Retractors

### Wundhaken



**Dimensions for blade size of retractors**

- 1st number = depth Example: 25 x 38 mm
- 2nd number = width

**Maßangaben für Blattgrößen der Wundhaken**

- 1. Zahl = Tiefe Beispiel: 25 x 38 mm
- 2. Zahl = Breite

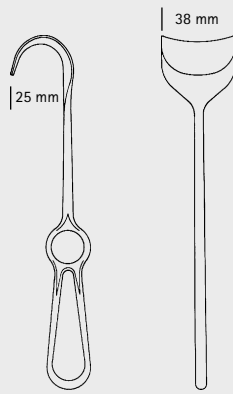

31 x 25 mm  
27 x 25 mm



27 x 25 mm  
31 x 25 mm

PARKER

**BT026R**

180 mm, 7"

21 x 14 mm  
17 x 14 mm

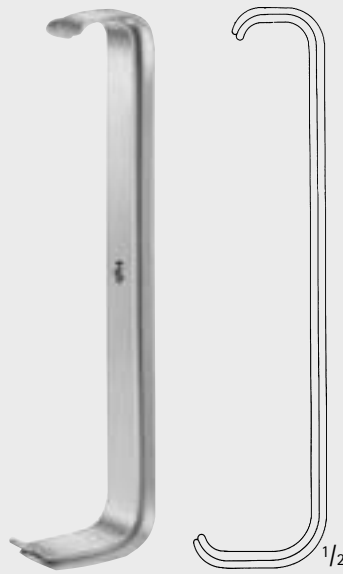

28 x 16 mm  
32 x 16 mm

COLLIN

**BT022R**

150 mm, 6"

# Retractors, Hooks – Retraktoren, Wundhaken

## Retractors Wundhaken



ROUX

**BT030R–BT033R**

Set complete, consisting of:

Satz komplett, bestehend aus:

BT031R

BT032R

BT033R

21 x 22 mm



27 x 28 mm

**BT031R**

145 mm, 5 3/4"

26 x 26 mm



32 x 36 mm

**BT032R**

155 mm, 6 1/8"

30 x 30 mm



36 x 44 mm

**BT033R**

165 mm, 6 1/2"

28 x 24 mm



ROUX

**BT028R**

170 mm, 6 3/4"

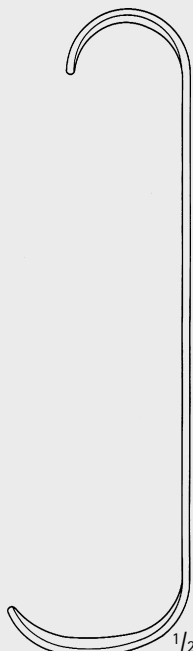

43 x 24 mm

28 x 28 mm



ROUX

**BT029R**

190 mm, 7 1/2"

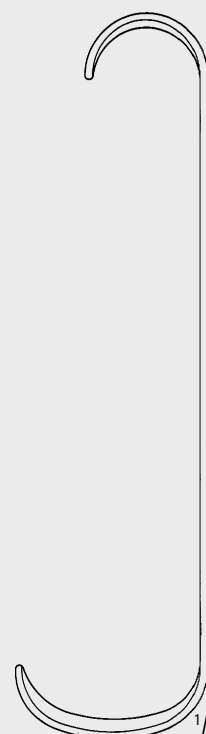

46 x 28 mm

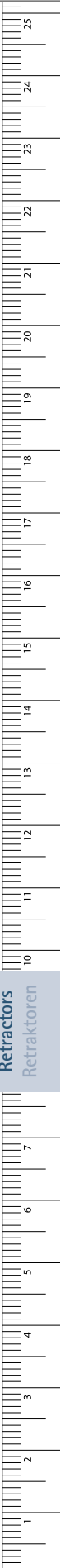

Retractors  
Retraktoren

MILLIMETERS

# Retractors, Hooks – Retraktoren, Wundhaken

## Retractors

## Wundhaken



### Dimensions for blade size of retractors

- 1st number = depth Example: 25 x 38 mm
- 2nd number = width

Maßangaben für Blattgrößen der Wundhaken

- 1. Zahl = Tiefe Beispiel: 25 x 38 mm
- 2. Zahl = Breite

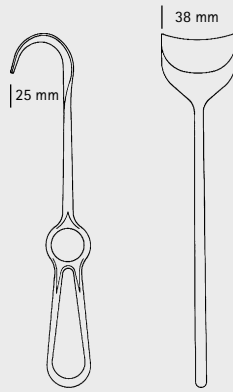

30 x 19 mm



33 x 25 mm

KILNER

**OL219R**

150 mm, 6"

35 x 29 mm

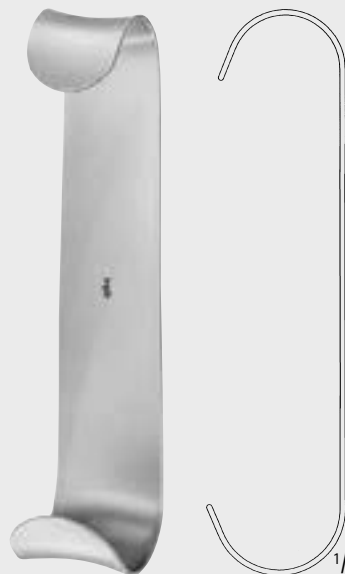

40 x 35 mm

KILNER

**OL220R**

150 mm, 6"

# Retractors, Hooks – Retraktoren, Wundhaken

## Retractors Wundhaken

20 x 22 mm

25 x 29 mm

1/2

ROUX  
**BT034R**  
150 mm, 6"

25 x 26 mm

30 x 38 mm

1/2

ROUX  
**BT035R**  
160 mm, 6 1/4"

28 x 29 mm

33 x 44 mm

1/2

ROUX  
**BT036R**  
170 mm, 6 3/4"

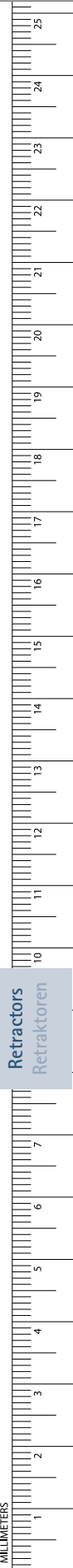

# Retractors, Hooks – Retraktoren, Wundhaken

## Retractors

## Wundhaken

### Dimensions for blade size of retractors

- 1st number = depth Example: 25 x 38 mm
- 2nd number = width

### Maßangaben für Blattgrößen der Wundhaken

- 1. Zahl = Tiefe Beispiel: 25 x 38 mm
- 2. Zahl = Breite

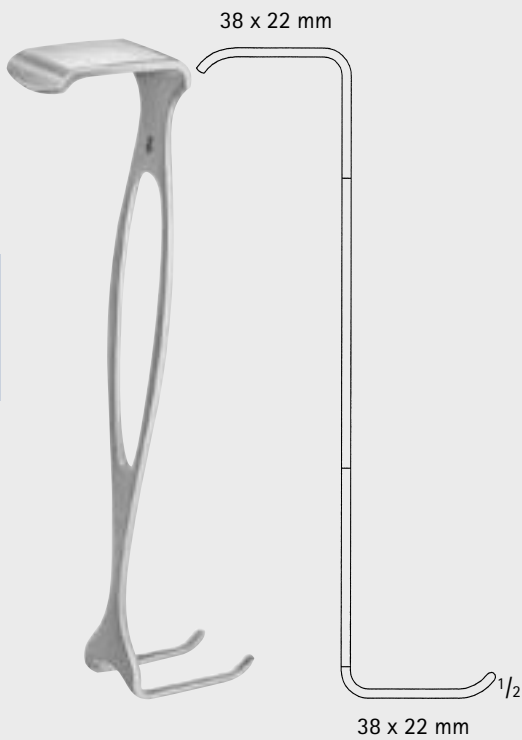
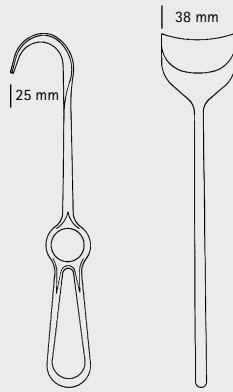

**CZERNY**  
**BT042R**  
175 mm, 6 7/8"

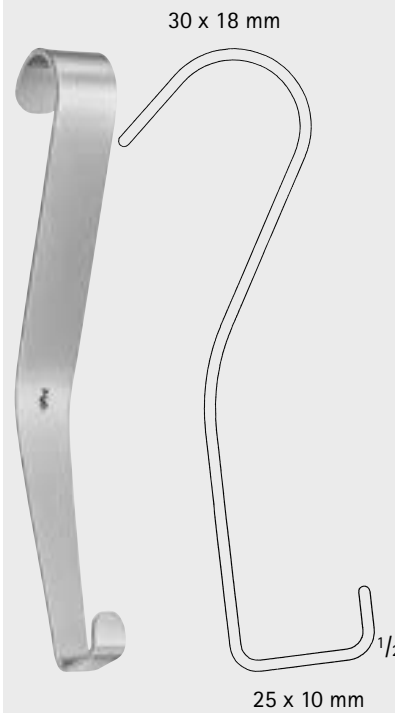

**HAJEK**  
**OL221R**  
165 mm, 6 1/2"

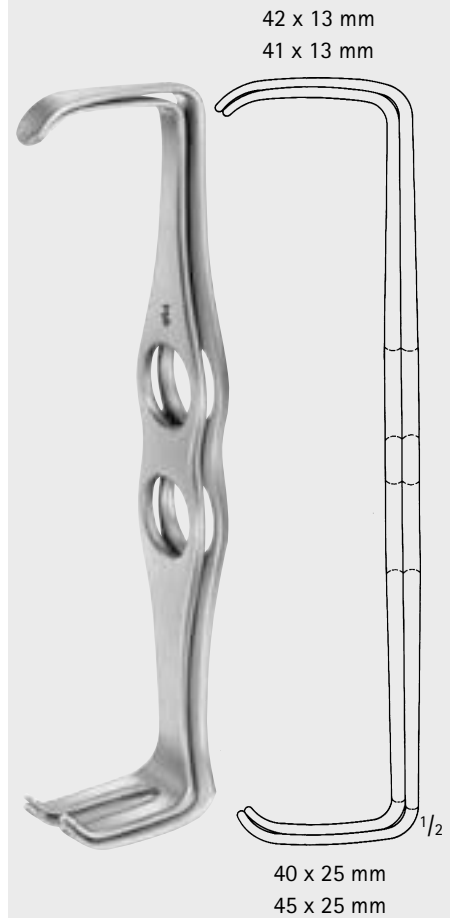

**MATHIEU**  
**BT040R**  
200 mm, 7 7/8"

Retractors  
Retraktoren

# Retractors, Hooks – Retraktoren, Wundhaken

## Retractors Wundhaken

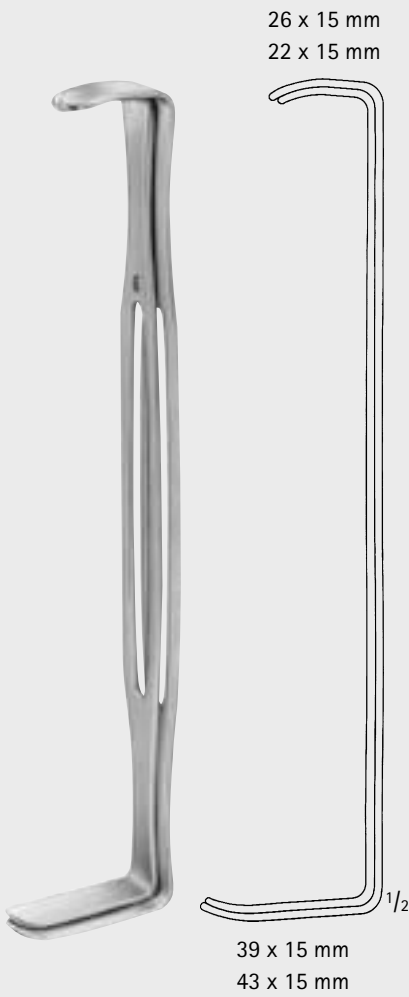

US-ARMY

**BT041R**

220 mm, 8 3/4"



GOELET

**MD497**

190 mm, 7 1/2"

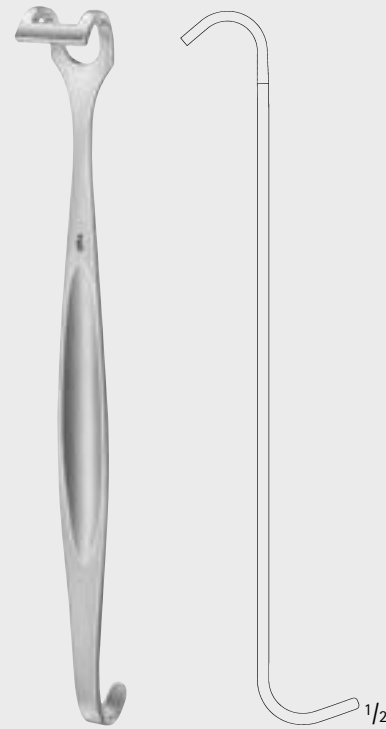

CANNY-RYALL

Art. No.	Width (mm)	Length
Art. Nr.	Breite (mm)	Länge
<b>BT047R</b>	16	190 mm, 7 1/2"
<b>BT048R</b>	20	190 mm, 7 1/2"
<b>BT049R</b>	25	200 mm, 7 7/8"

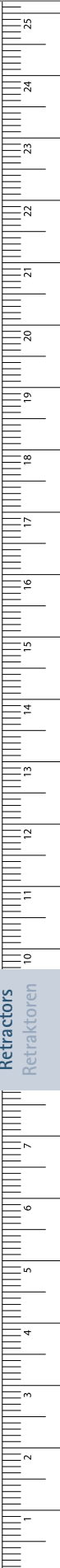

# Retractors, Hooks – Retraktoren, Wundhaken

## Bone Retractors and Retractors

### Knochen- und Wundhaken

**Dimensions for blade size of retractors**

- 1st number = depth Example: 25 x 38 mm
- 2nd number = width

**Maßangaben für Blattgrößen der Wundhaken**

- 1. Zahl = Tiefe Beispiel: 25 x 38 mm
- 2. Zahl = Breite

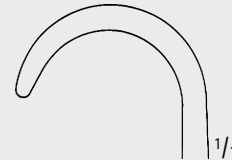
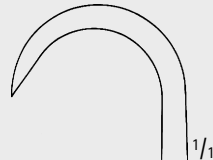
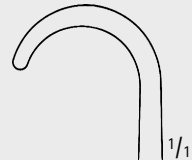
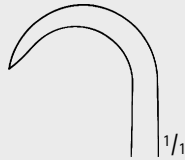
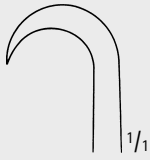
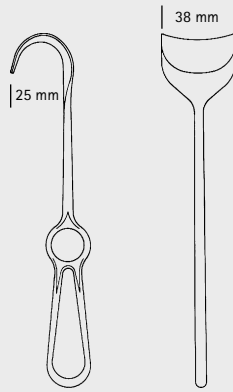

**KOCHER**  
**BT234R**  
sharp  
scharf  
205 mm, 8"



**KOCHER**  
**BT238R**  
sharp  
scharf  
220 mm, 8 3/4"



**KOCHER**  
**BT239R**  
blunt  
stumpf  
220 mm, 8 3/4"



**VOLKMANN**  
**BT240R**  
sharp  
scharf  
220 mm, 8 3/4"



**VOLKMANN**  
**BT241R**  
blunt  
stumpf  
220 mm, 8 3/4"



**BT232R**  
sharp  
scharf  
245 mm, 9 5/8"



# Retractors, Hooks – Retraktoren, Wundhaken

## Bone Retractors and Retractors

### Knochen- und Wundhaken



VOLKMANN

**BT221R**

sharp  
scharf  
220 mm, 8 3/4"

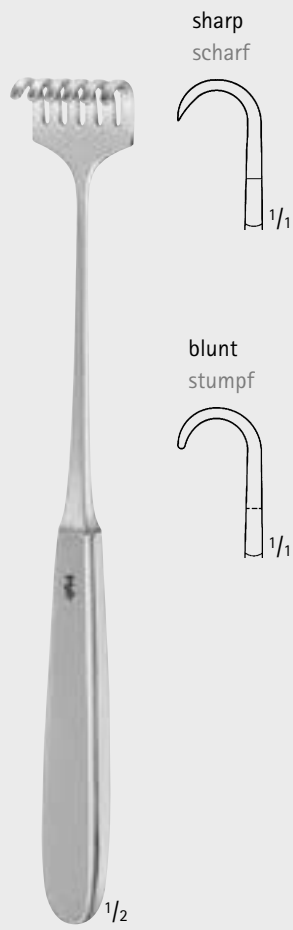

VOLKMANN

**BT222R–BT230R**

225 mm, 8 7/8"

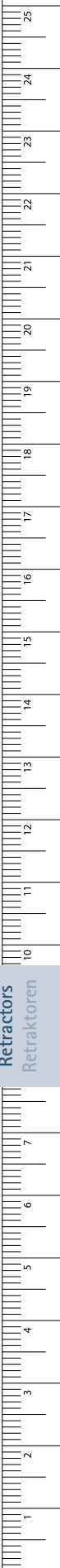
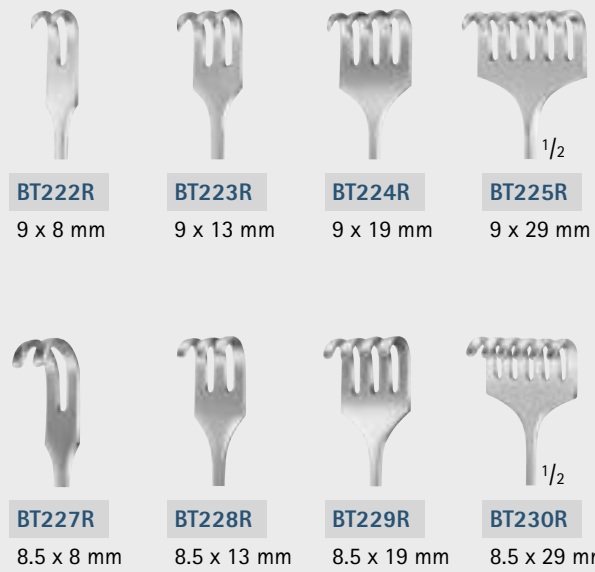

# Retractors, Hooks – Retraktoren, Wundhaken

## Retractors

## Wundhaken

### Dimensions for blade size of retractors

- 1st number = depth Example: 25 x 38 mm
- 2nd number = width

### Maßangaben für Blattgrößen der Wundhaken

- 1. Zahl = Tiefe Beispiel: 25 x 38 mm
- 2. Zahl = Breite

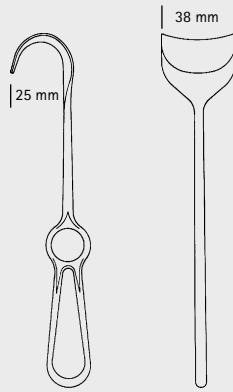

sharp  
scharf

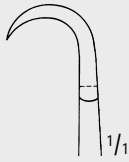

**BT242R**  
9 x 8 mm



**BT243R**  
9 x 13 mm



**BT244R**  
9 x 19 mm



**BT246R**  
9 x 29 mm

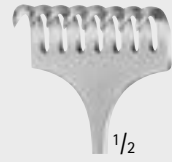

**BT248R**  
9 x 40 mm

blunt  
stumpf

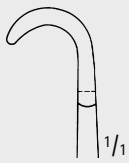

**BT252R**  
8 x 8 mm



**BT253R**  
8 x 13 mm



**BT254R**  
8 x 19 mm



**BT256R**  
8 x 29 mm

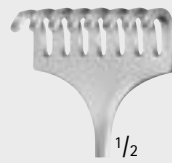

**BT258R**  
8 x 40 mm

semi-sharp  
halbscharf



**BT257R**  
8.5 x 8 mm



**BT259R**  
8.5 x 13 mm



**BT260R**  
8.5 x 19 mm



**BT261R**  
8.5 x 29 mm



**BT265R**  
8.5 x 40 mm



VOLKMANN

**BT242R-BT265R**

220 mm, 8 3/4"

Retractors  
Retraktoren

# Retractors, Hooks – Retraktoren, Wundhaken

## Retractors

## Wundhaken



MURPHY

BT293R–BT296R

195 mm, 7 3/4"



BT293R

sharp  
scharf



BT294R

sharp  
scharf



BT295R

blunt  
stumpf



BT296R

blunt  
stumpf

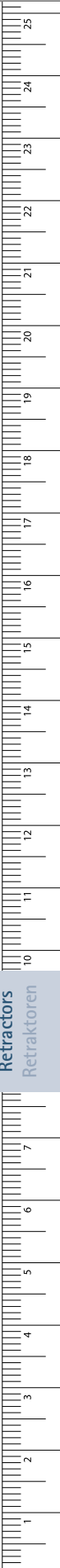

Retractors  
Retraktoren

# Retractors, Hooks – Retraktoren, Wundhaken

## Retractors

### Wundhaken

#### Dimensions for blade size of retractors

- 1st number = depth Example: 25 x 38 mm
- 2nd number = width

#### Maßangaben für Blattgrößen der Wundhaken

- 1. Zahl = Tiefe Beispiel: 25 x 38 mm
- 2. Zahl = Breite

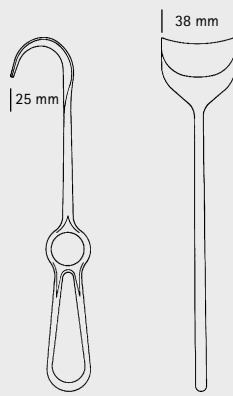

LANGENBECK  
BT311R–BT316R  
230 mm, 9"

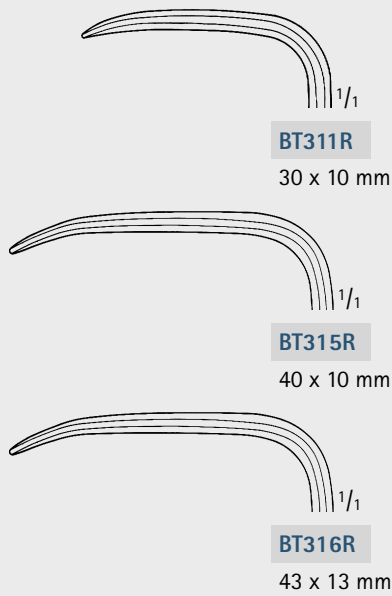

BT311R  
30 x 10 mm

BT315R  
40 x 10 mm

BT316R  
43 x 13 mm



LANGENBECK  
BT320R–BT326R  
210 mm, 8 1/4"

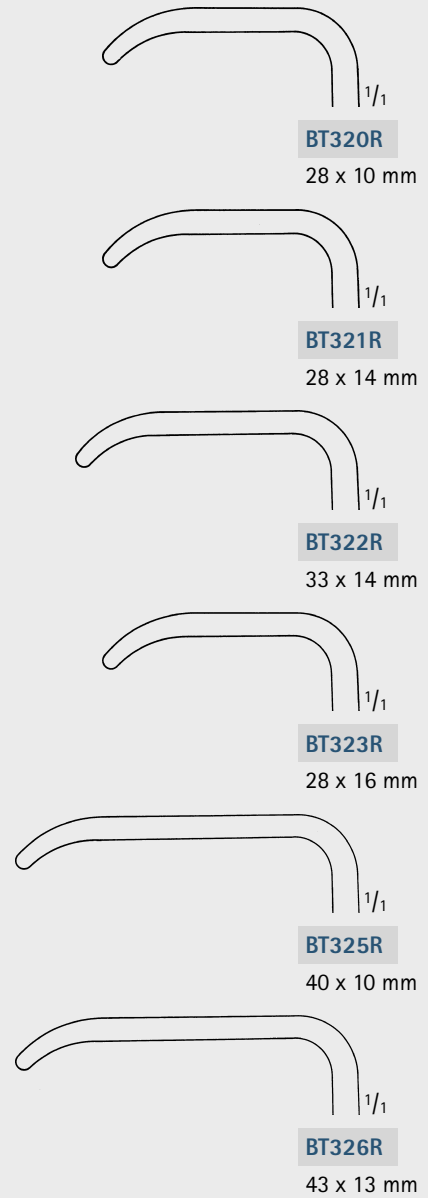

BT320R  
28 x 10 mm

BT321R  
28 x 14 mm

BT322R  
33 x 14 mm

BT323R  
28 x 16 mm

BT325R  
40 x 10 mm

BT326R  
43 x 13 mm

Retractors  
Retraktoren

INCHES

# Retractors, Hooks – Retraktoren, Wundhaken

## Retractors Wundhaken



KOCHER-LANGENBECK

BT354R–BT365R

215 mm, 8 1/2"

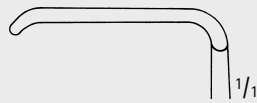

BT354R

25 x 6 mm

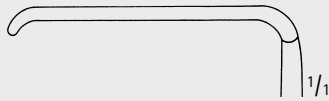

BT356R

35 x 8 mm

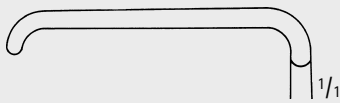

BT357R

35 x 11 mm

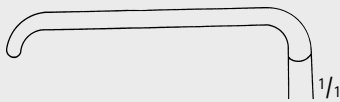

BT358R

35 x 15 mm

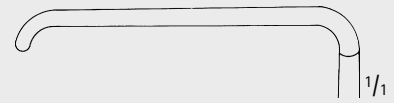

BT359R

41 x 11 mm

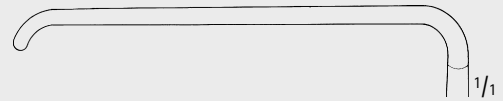

BT361R

55 x 11 mm

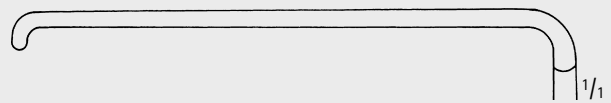

BT363R

70 x 14 mm

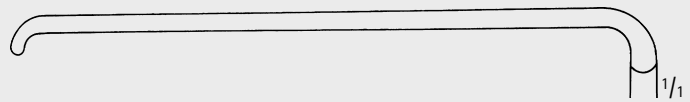

BT364R

80 x 12 mm

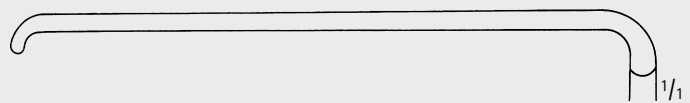

BT365R

80 x 16 mm

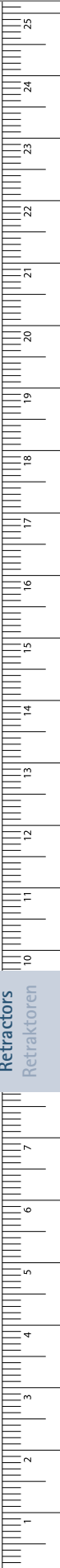

Retractors  
Retraktoren

MILLIMETERS

# Retractors, Hooks – Retraktoren, Wundhaken

## Retractors

### Wundhaken

#### Dimensions for blade size of retractors

- 1st number = depth Example: 25 x 38 mm
- 2nd number = width

#### Maßangaben für Blattgrößen der Wundhaken

- 1. Zahl = Tiefe Beispiel: 25 x 38 mm
- 2. Zahl = Breite

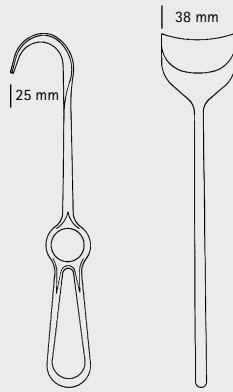

KOCHER

**BT340R**

210 mm, 8 1/4"

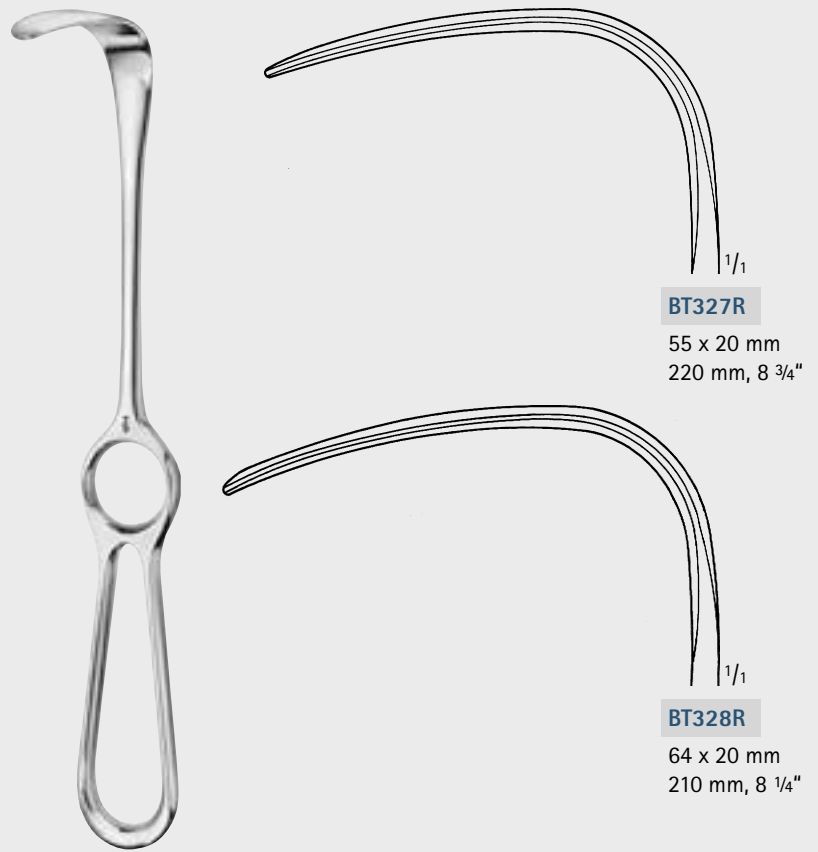

LANGENBECK

**BT327R-BT328R**

**BT327R**

55 x 20 mm  
220 mm, 8 3/4"

**BT328R**

64 x 20 mm  
210 mm, 8 1/4"

Retractors  
Retraktoren

INCHES

# Retractors, Hooks – Retraktoren, Wundhaken

## Retractors Wundhaken

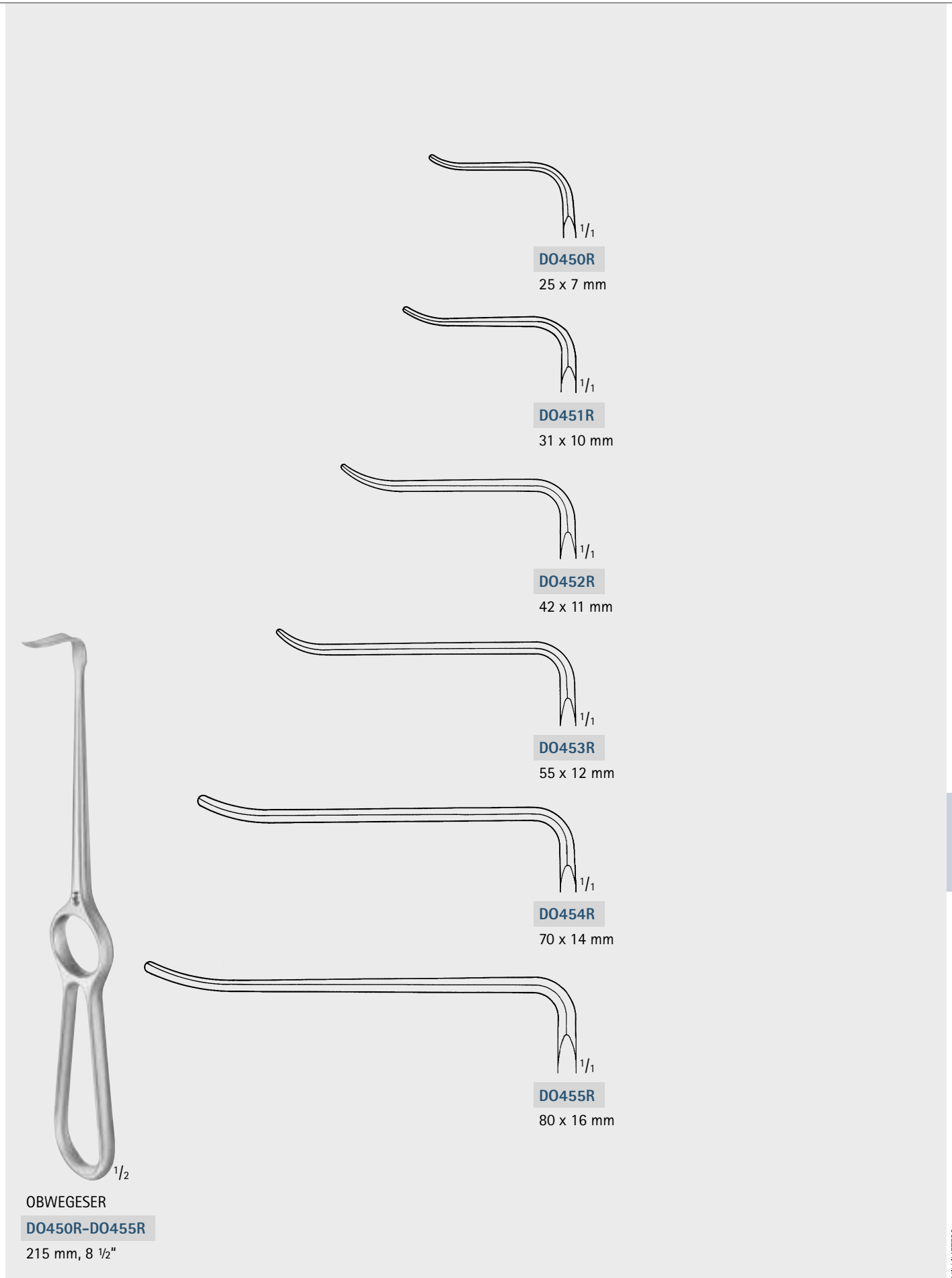

**DO450R**

25 x 7 mm

**DO451R**

31 x 10 mm

**DO452R**

42 x 11 mm

**DO453R**

55 x 12 mm

**DO454R**

70 x 14 mm

**DO455R**

80 x 16 mm

OBWEGESER

**DO450R-DO455R**

215 mm, 8 1/2"

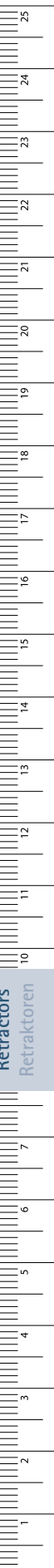

Retractors  
Retraktoren

MILLIMETERS

# Retractors, Hooks – Retraktoren, Wundhaken

## Retractors

### Wundhaken

#### Dimensions for blade size of retractors

- 1st number = depth Example: 25 x 38 mm
- 2nd number = width

#### Maßangaben für Blattgrößen der Wundhaken

- 1. Zahl = Tiefe Beispiel: 25 x 38 mm
- 2. Zahl = Breite

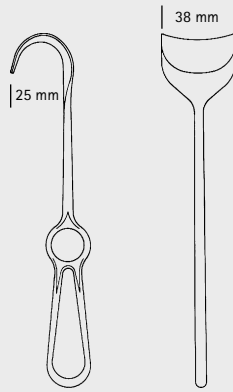

OBWEGESER  
DO460R-DO465R

215 mm, 8 1/2"



DO460R  
25 x 7 mm



DO461R  
31 x 10 mm

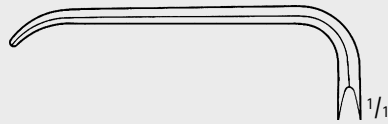

DO462R  
42 x 11 mm

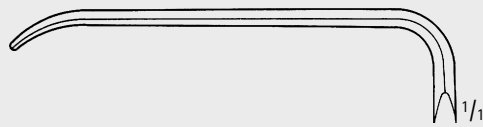

DO463R  
55 x 12 mm

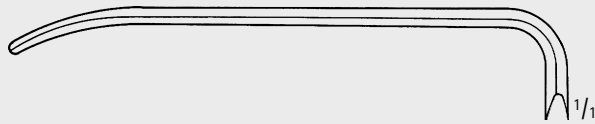

DO464R  
70 x 14 mm

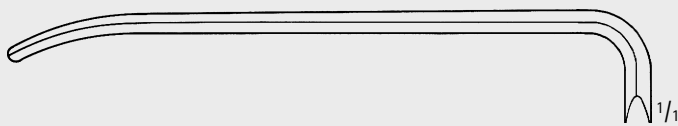

DO465R  
80 x 16 mm

Retractors  
Retraktoren



# Retractors, Hooks – Retraktoren, Wundhaken

## Retractors Wundhaken

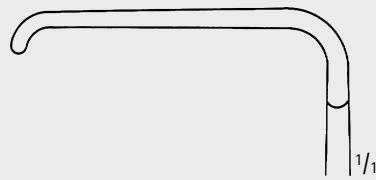

**BT369R**

40 x 18 mm

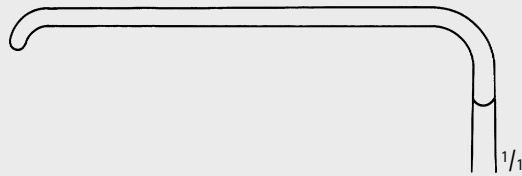

**BT370R**

60 x 20 mm

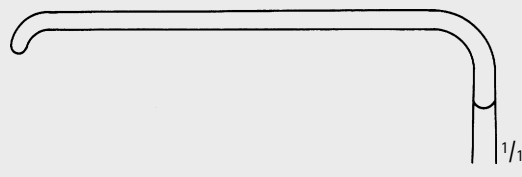

**BT371R**

60 x 25 mm

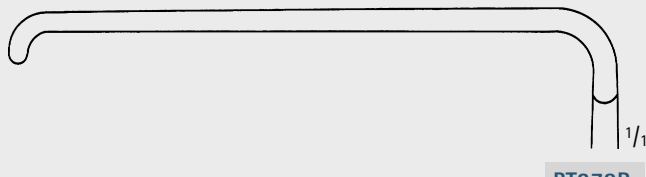

**BT372R**

75 x 30 mm

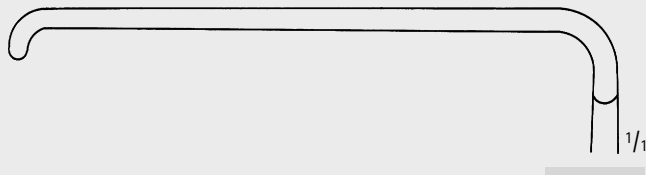

**BT373R**

75 x 40 mm



KOCHER

**BT369R–BT373R**

230 mm, 9"

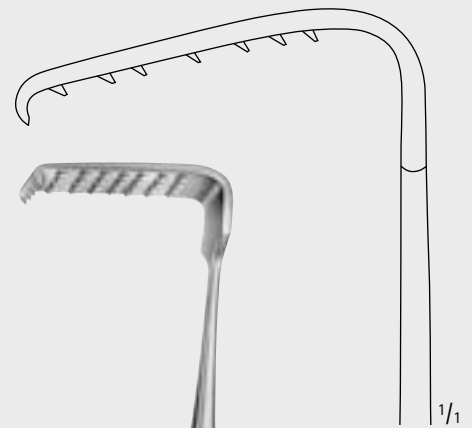

BRÜNINGS-BRUNK

**OK800R**

Antrum retractor  
Kieferhöhlenhaken  
190 mm, 7 1/2"

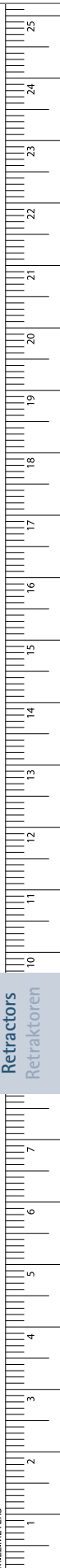

# Retractors, Hooks – Retraktoren, Wundhaken

## Retractors

### Wundhaken

#### Dimensions for blade size of retractors

- 1st number = depth Example: 25 x 38 mm
- 2nd number = width

Maßangaben für Blattgrößen der Wundhaken

- 1. Zahl = Tiefe Beispiel: 25 x 38 mm
- 2. Zahl = Breite

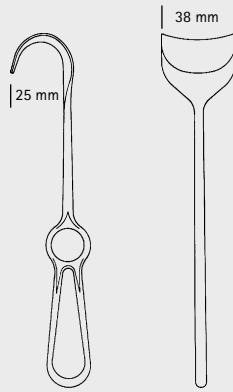

SAUERBRUCH  
BT351R–BT353R

225 mm, 8 7/8"

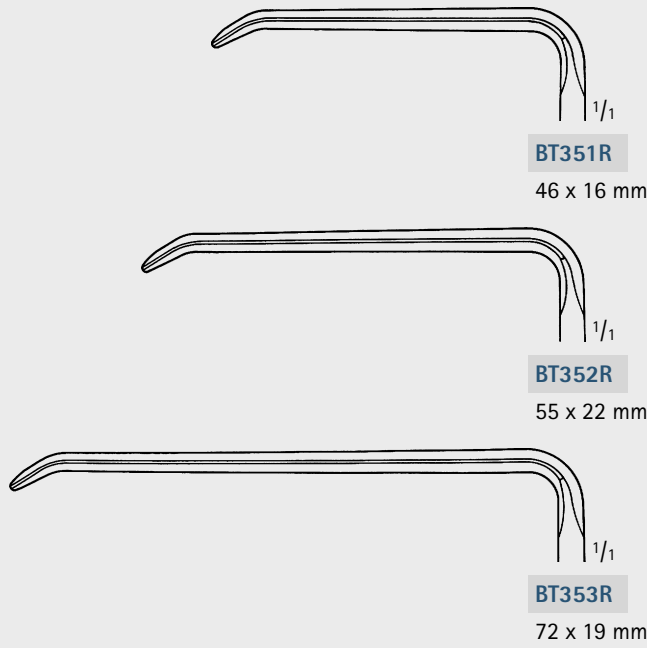

BT351R  
46 x 16 mm

BT352R  
55 x 22 mm

BT353R  
72 x 19 mm



LAHEY  
MB785R

200 mm, 7 7/8"

Retractors  
Retraktoren

# Retractors, Hooks – Retraktoren, Wundhaken

Retractors  
Wundhaken

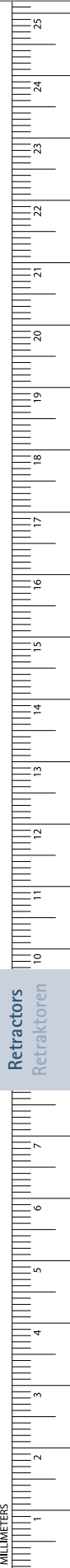
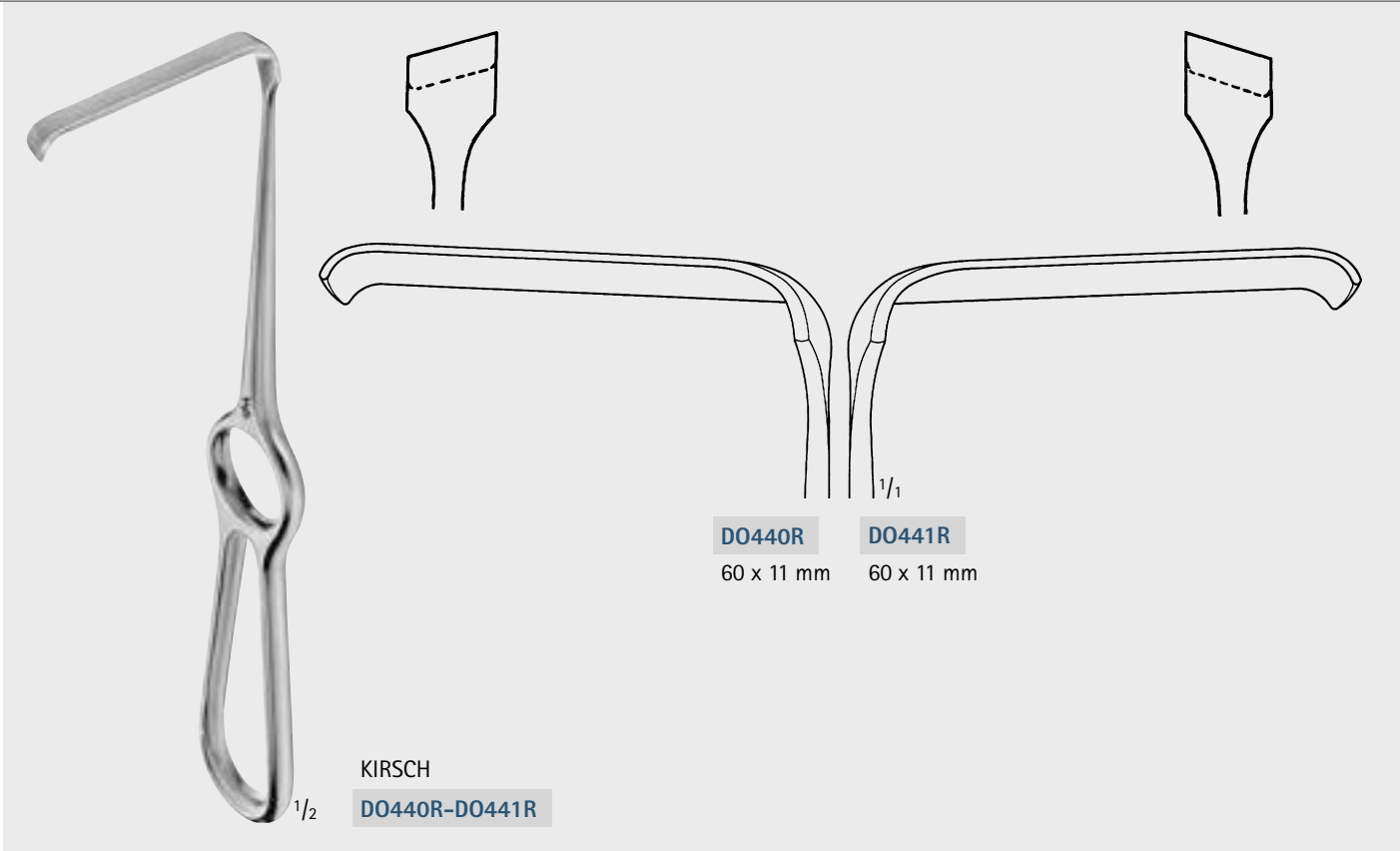

Retractors  
Retraktoren

# Retractors, Hooks – Retraktoren, Wundhaken

## Retractors

### Wundhaken

#### Dimensions for blade size of retractors

- 1st number = depth Example: 25 x 38 mm
- 2nd number = width

#### Maßangaben für Blattgrößen der Wundhaken

- 1. Zahl = Tiefe Beispiel: 25 x 38 mm
- 2. Zahl = Breite

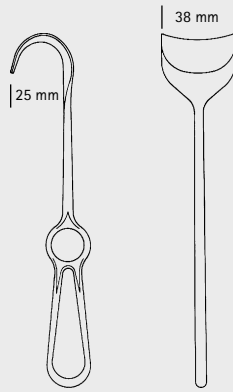

**BT404R**

15 x 15 mm  
220 mm, 8 3/4"

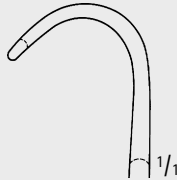

MIDDENDORPF

**BT404R-BT406R**



**BT405R**

20 x 22 mm  
215 mm, 8 1/2"

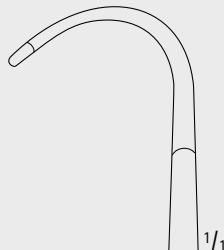

**BT406R**

28 x 28 mm  
235 mm, 9 1/4"

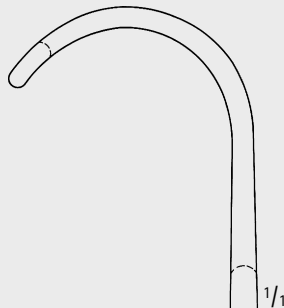

GREENE

**BT408R**

225 mm, 8 7/8"



28 x 22 mm

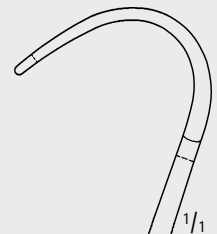

Retractors  
Retraktoren

INCHES

# Retractors, Hooks – Retraktoren, Wundhaken

## Retractors Wundhaken



BÜCHS  
DO432R  
205 mm, 8"

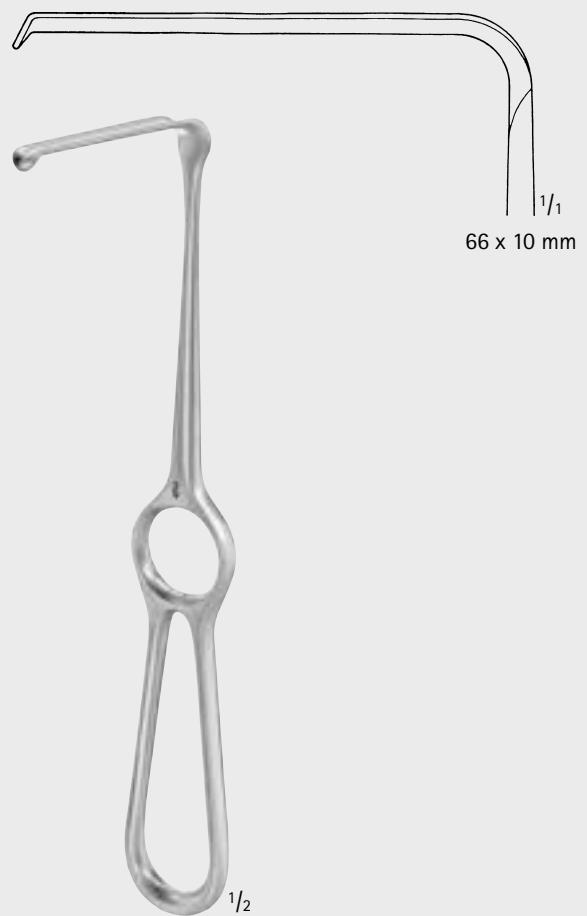

KRÄMER  
BT464R  
210 mm, 8  $\frac{1}{4}$ "

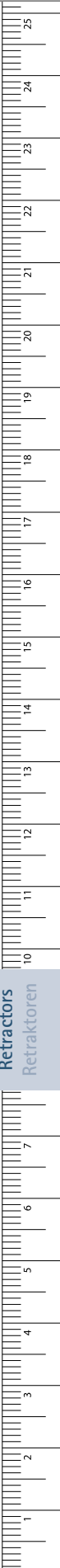

# Retractors, Hooks – Retraktoren, Wundhaken

## Retractors

### Wundhaken



**Dimensions for blade size of retractors**

- 1st number = depth Example: 25 x 38 mm
- 2nd number = width

**Maßangaben für Blattgrößen der Wundhaken**

- 1. Zahl = Tiefe Beispiel: 25 x 38 mm
- 2. Zahl = Breite

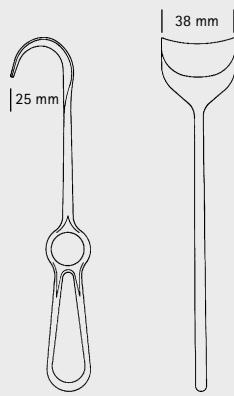

CASPAR  
**BT465R**  
 210 mm, 8 1/4"

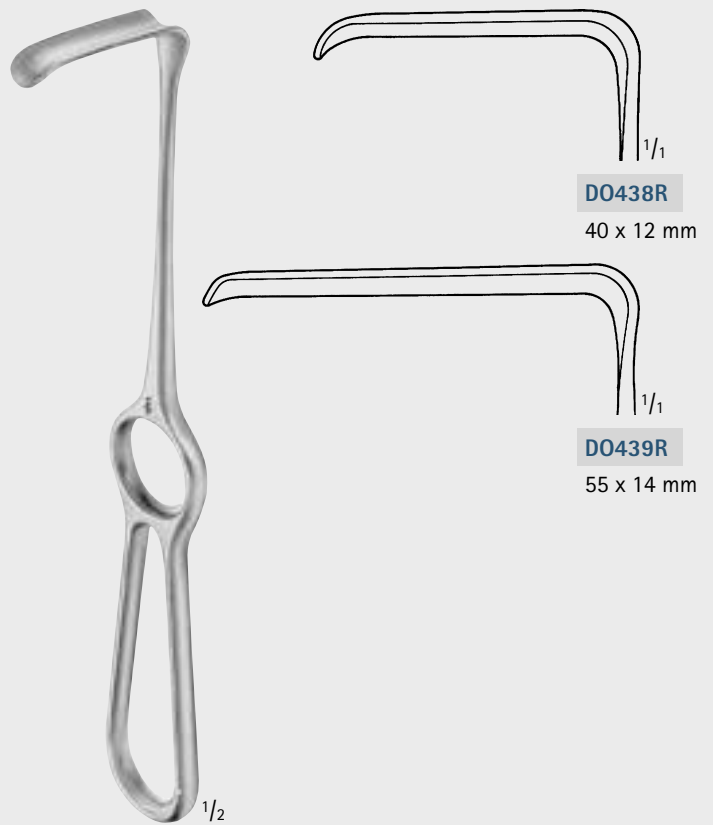

DOCKHORN  
**DO438R-DO439R**  
 210 mm, 8 1/4"

# Retractors, Hooks – Retraktoren, Wundhaken

## Retractors Wundhaken



KOCHER

**BT459R**

230 mm, 9"



ZENKER

**BT594R**

240 mm, 9 1/2"

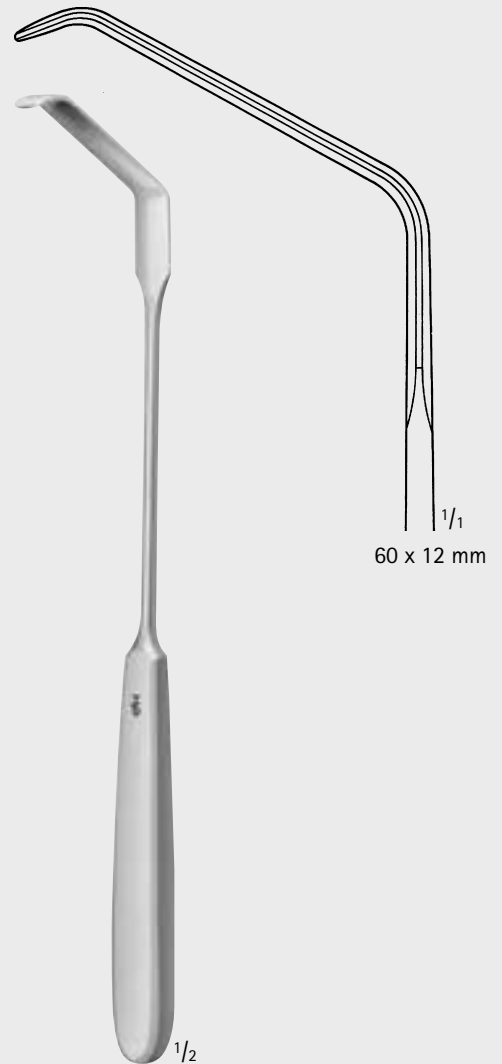

ZENKER

**BT595R**

255 mm, 10"

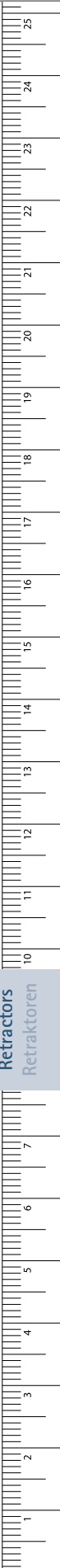

# Retractors, Hooks – Retraktoren, Wundhaken

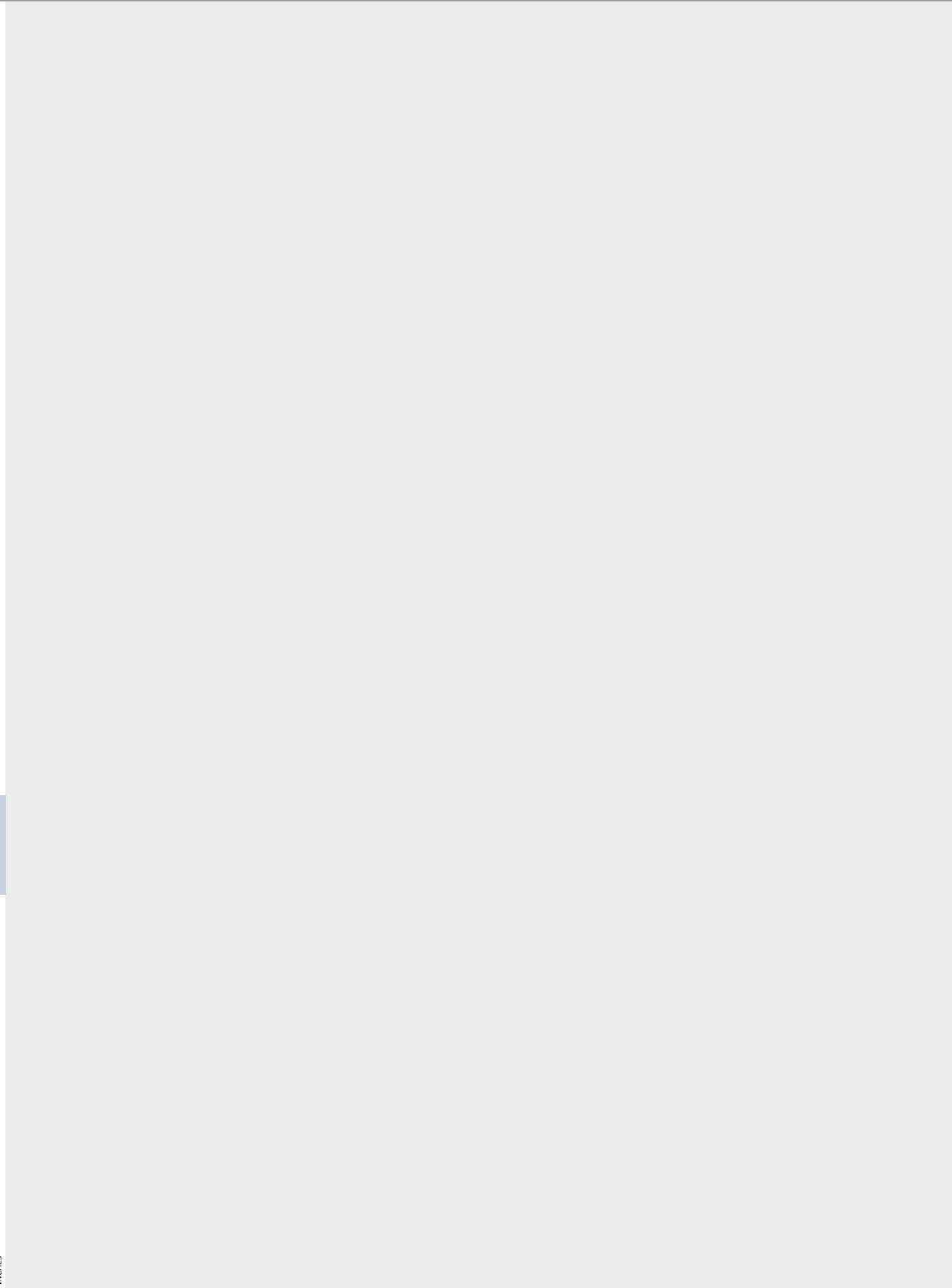



General Surgical Instruments  
Chirurgische Instrumente



# General Surgical Instruments - Chirurgische Instrumente

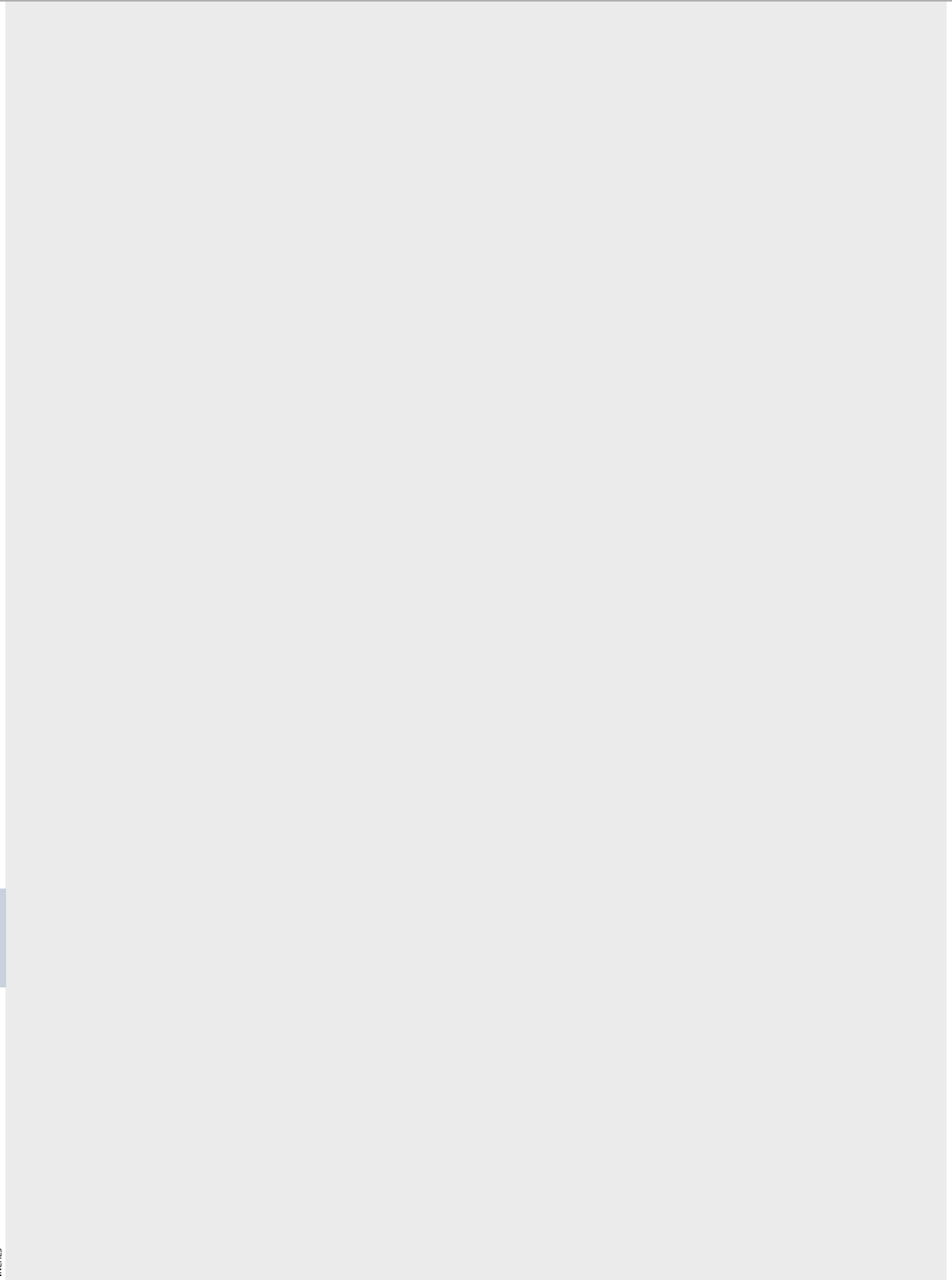

## General Surgical Instruments Chirurgische Instrumente

- Preparation
- Vorbereitung

# Patient Preparation – Patienten-Vorbereitung

## Sponge- and Dressing Forceps

### Korn- und Tupferzangen

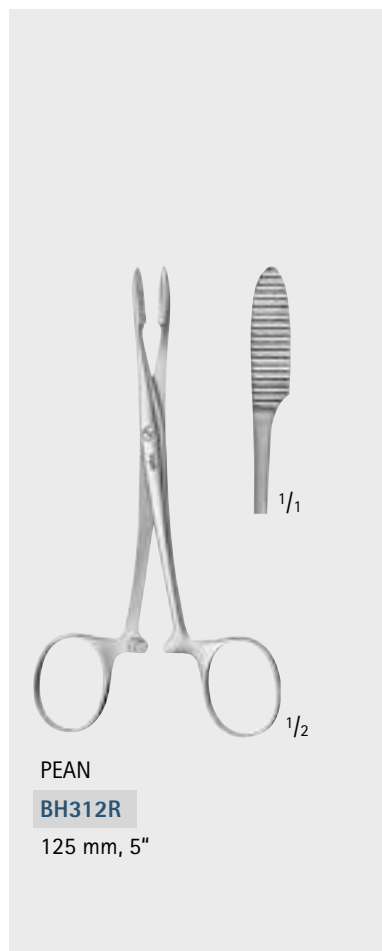
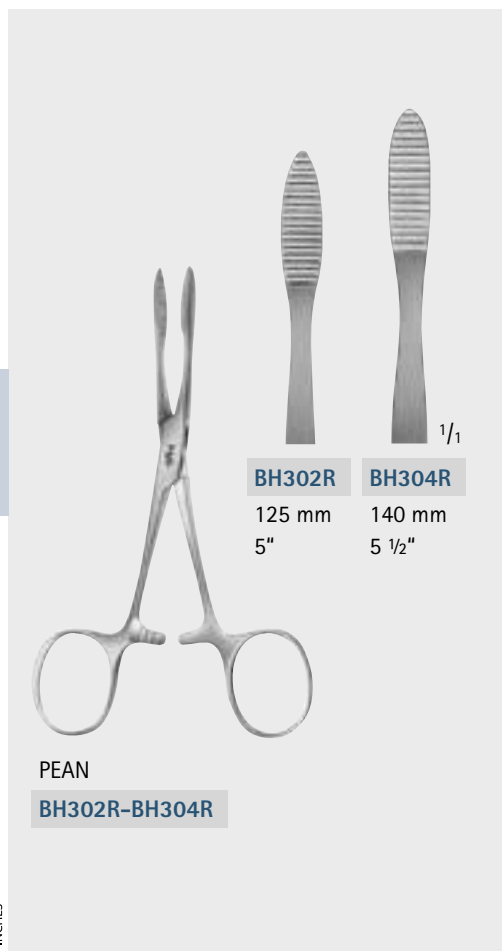
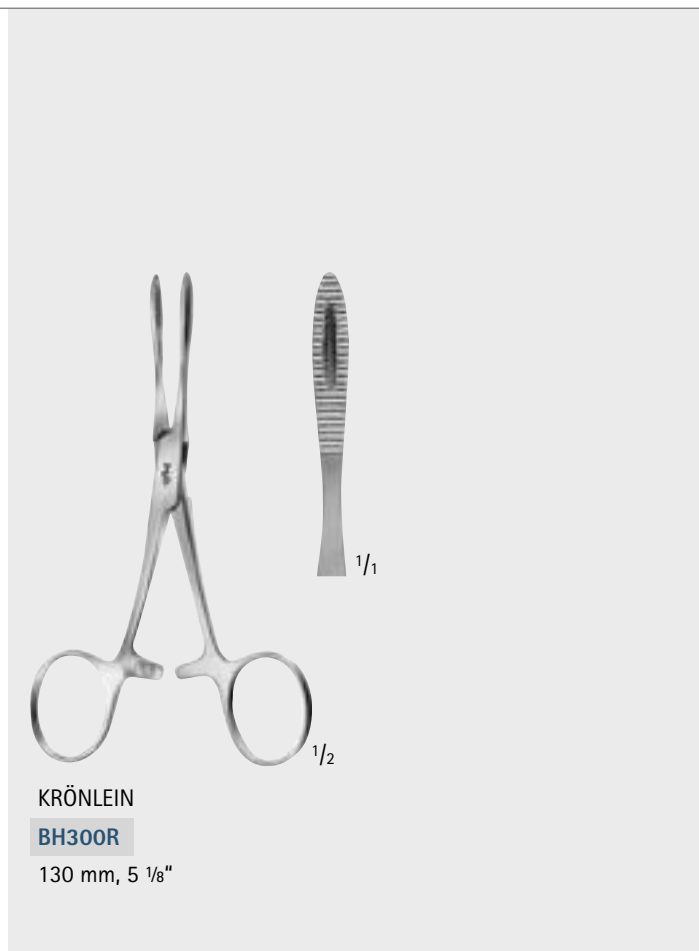
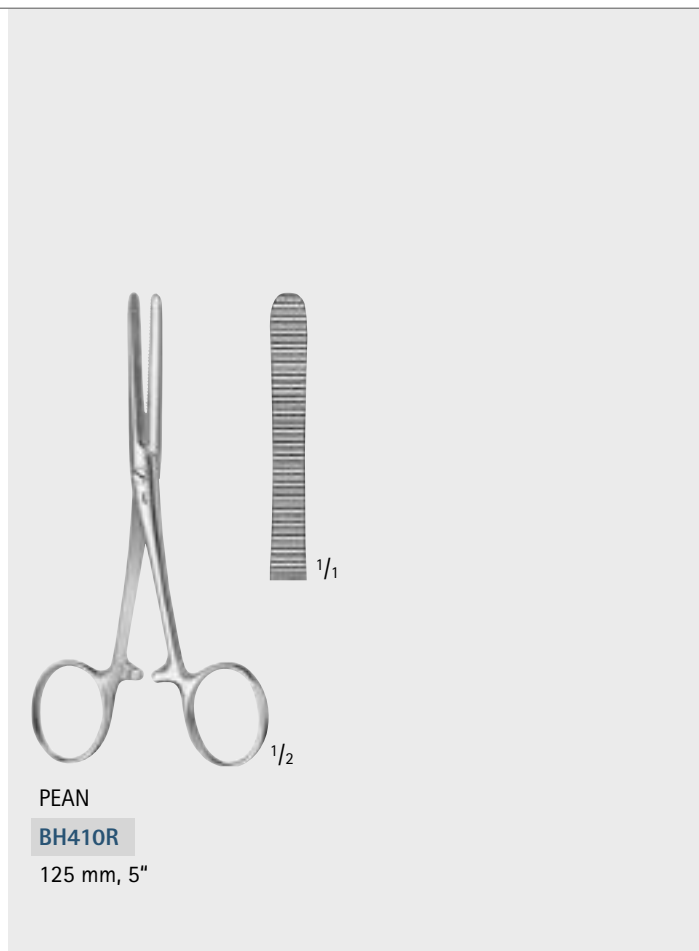

Preparation  
Vorbereitung

# Patient Preparation – Patienten-Vorbereitung

## Sponge- and Dressing Forceps

### Korn- und Tupferzangen

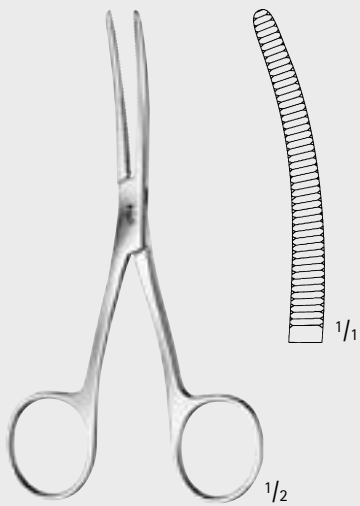

**BRYANT**  
**BF003R**  
130 mm, 5 1/8"

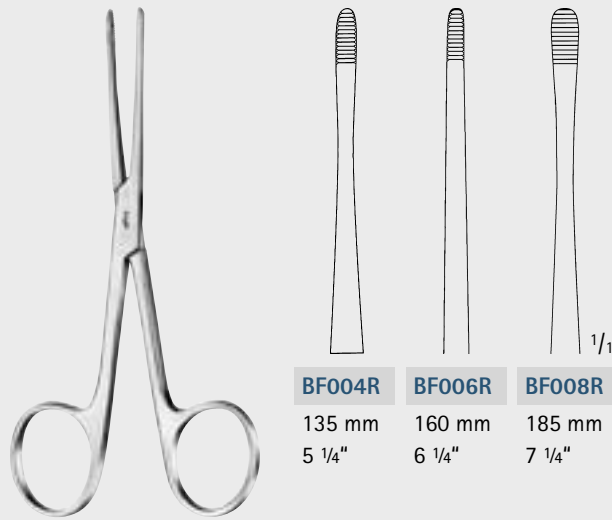

**LISTER**  
**BF004R–BF008R**  
Sinus forceps  
Sinusklemmen

BF004R	BF006R	BF008R
135 mm	160 mm	185 mm
5 1/4"	6 1/4"	7 1/4"

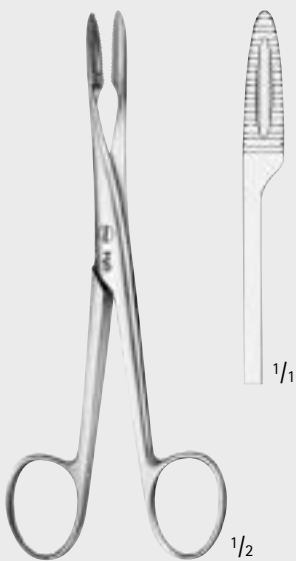

**BF010R**  
without ratchet  
ohne Sperre  
145 mm, 5 3/4"



**BF016R**  
with ratchet  
mit Sperre  
145 mm, 5 3/4"

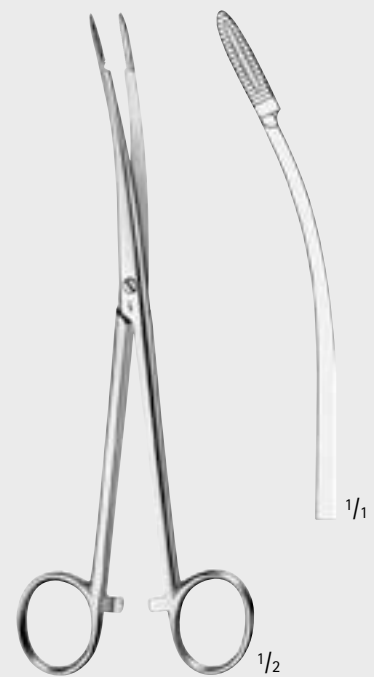

**BF021R**  
175 mm, 6 7/8"

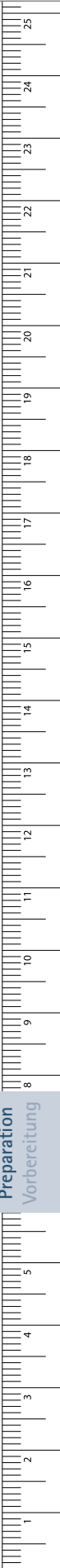

# Patient Preparation – Patienten-Vorbereitung

## Sponge- and Dressing Forceps

### Korn- und Tupferzangen

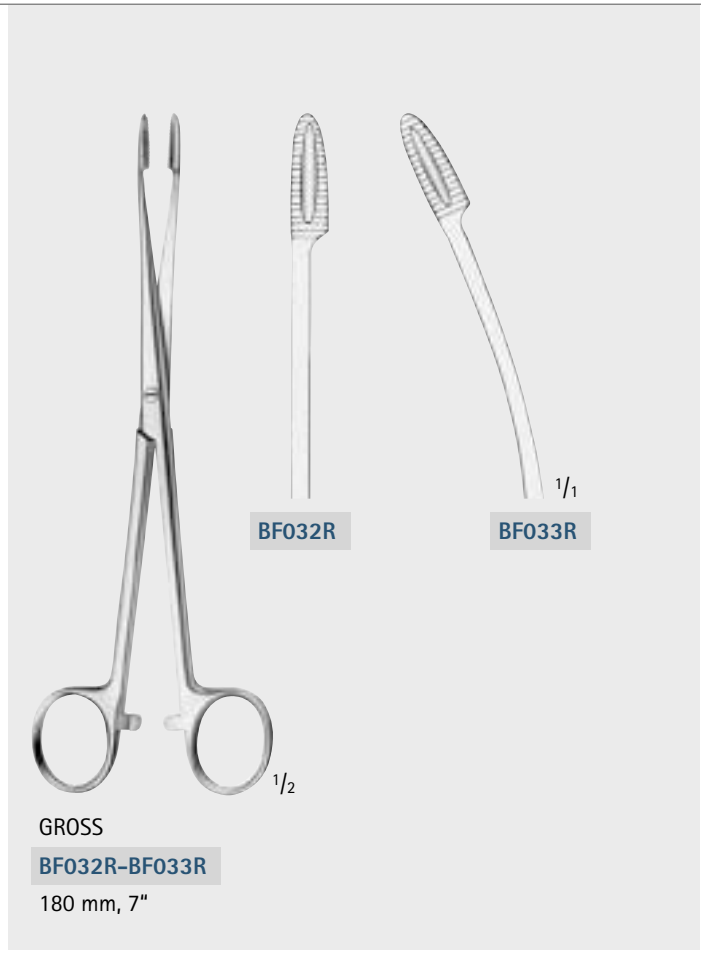
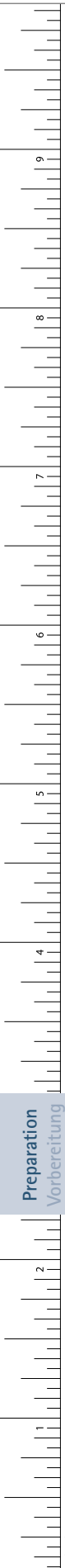

**BF032R**

**BF033R**

GROSS

**BF032R-BF033R**

180 mm, 7"

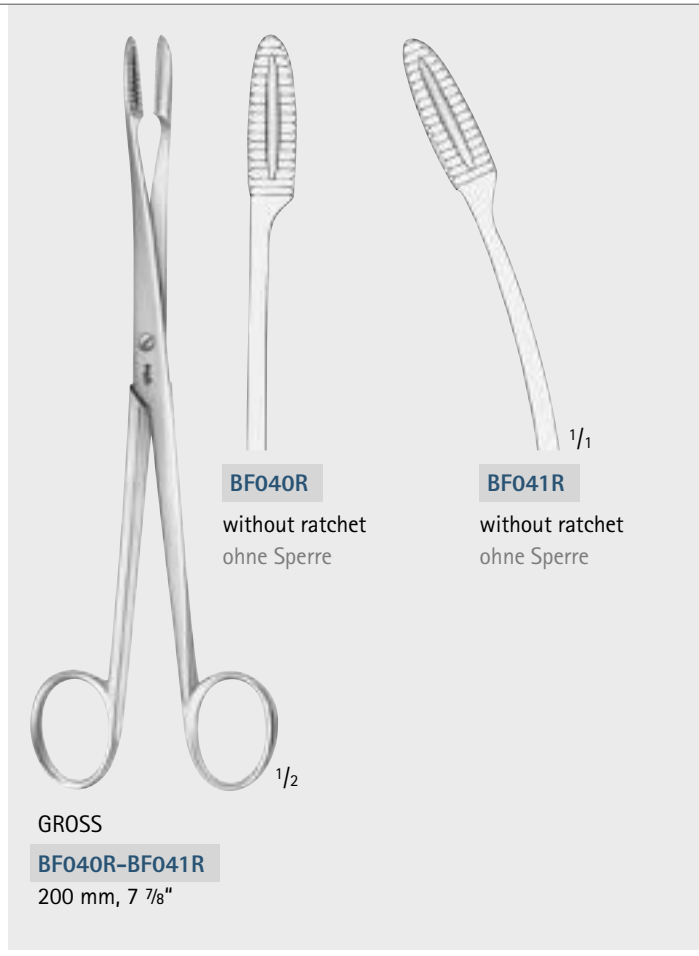

**BF040R**

without ratchet  
ohne Sperre

**BF041R**

without ratchet  
ohne Sperre

GROSS

**BF040R-BF041R**

200 mm, 7 7/8"

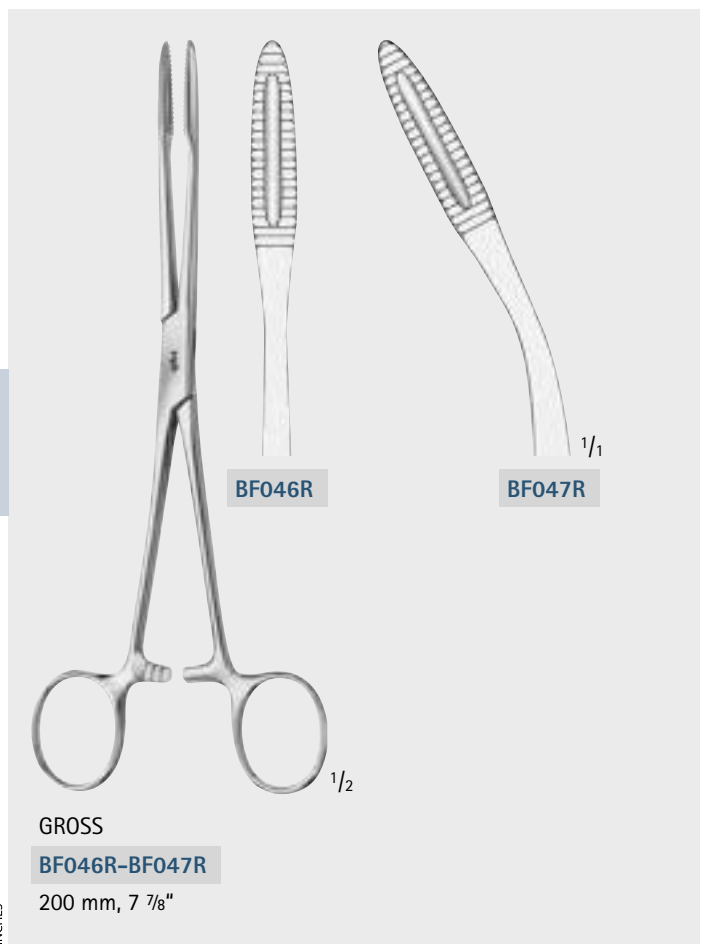

**BF046R**

**BF047R**

GROSS

**BF046R-BF047R**

200 mm, 7 7/8"



DUPLAY

**BF027R**

210 mm, 8 1/4"

Preparation  
Vorbereitung

# Patient Preparation – Patienten-Vorbereitung

## Sponge- and Dressing Forceps

### Korn-, Tupfer- und Waschzangen

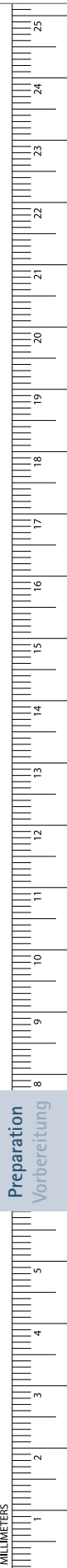
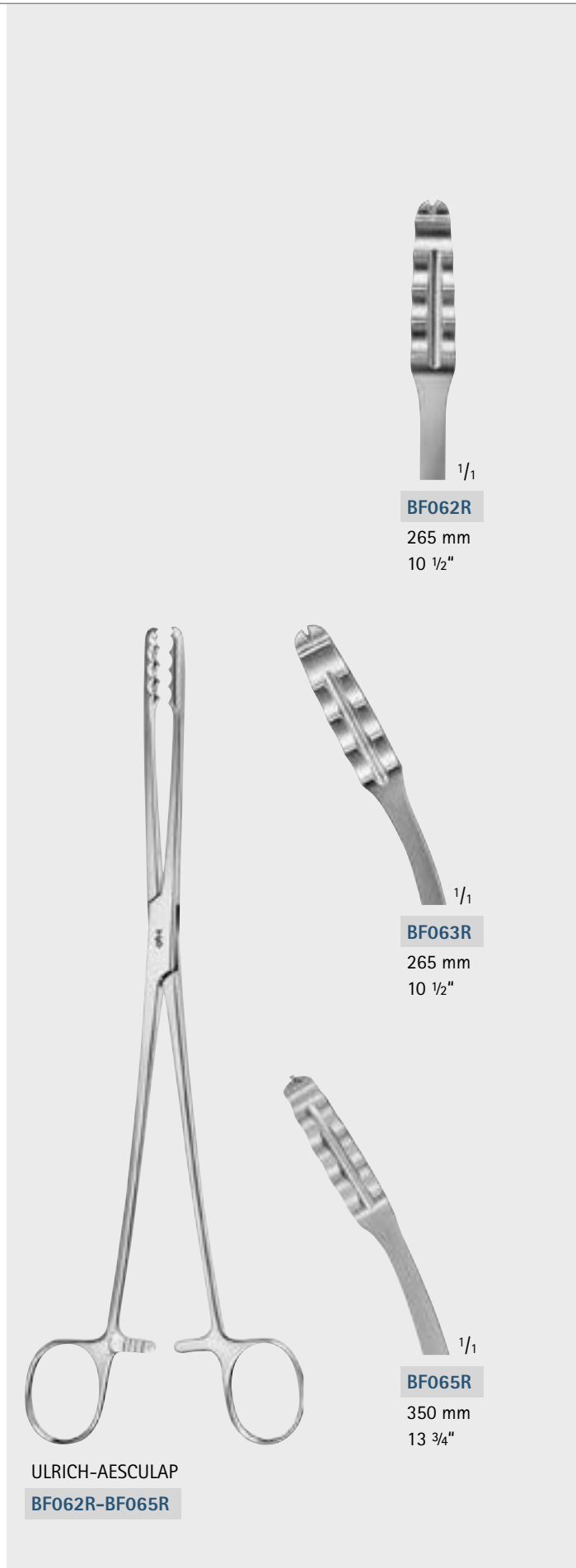
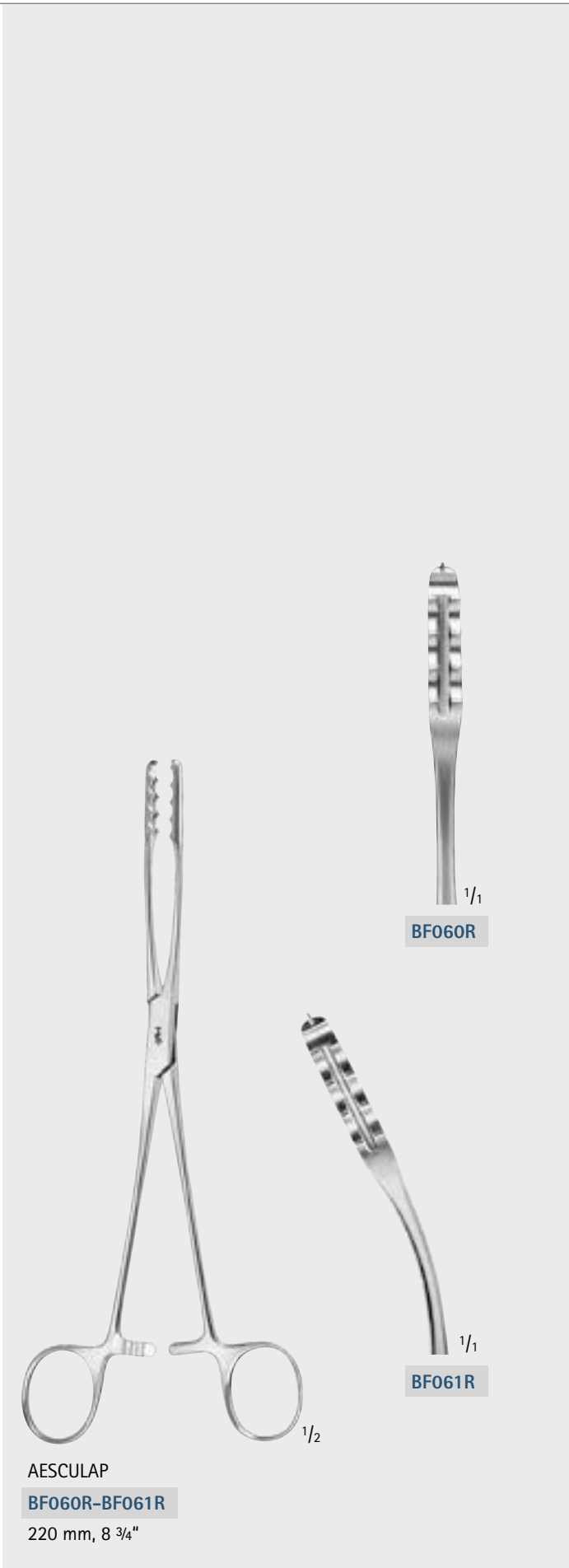

## Patient Preparation – Patienten-Vorbereitung

### Sponge- and Dressing Forceps

Korn-, Tupfer- und Waschzangen



Preparation  
Vorbereitung



**MAIER**  
**BF056R-BF057R**  
without ratchet  
ohne Sperre  
265 mm, 10 1/2"

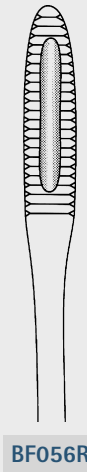

**BF056R**

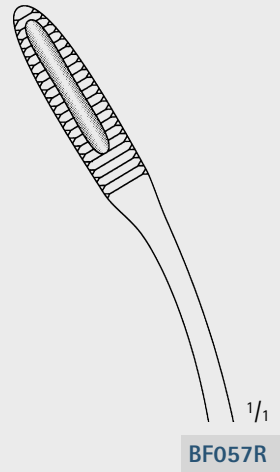

**BF057R** 1/1



**MAIER**  
**BF058R-BF059R**  
with ratchet  
mit Sperre  
260 mm, 10 1/4"

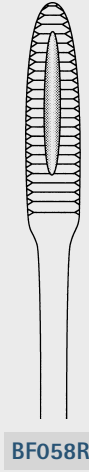

**BF058R**

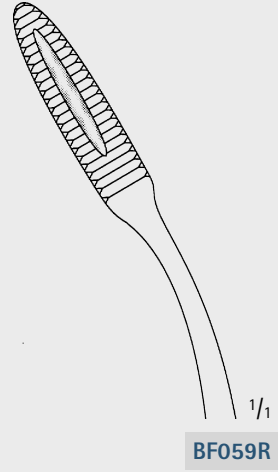

**BF059R** 1/1



# Patient Preparation – Patienten-Vorbereitung

## Sponge- and Dressing Forceps

### Korn-, Tupfer- und Waschzangen



1/1

**BF076R**

280 mm, 11"

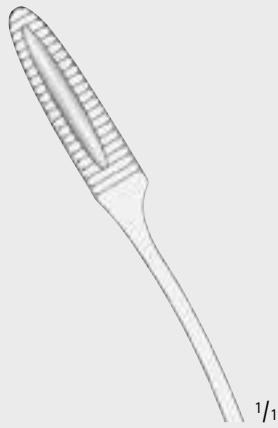

1/1

**BF077R**

280 mm, 11"



1/1

**BF078R**

350 mm, 13 3/4"



SIMS-MAIER

**BF076R-BF078R**



1/2

**BF070R-BF071R**

240 mm, 9 1/2"



1/1

**BF070R**



1/1

**BF071R**

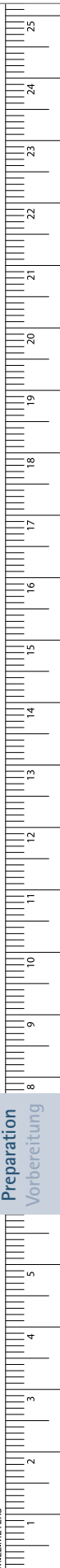

Preparation  
Vorbereitung

# Patient Preparation – Patienten-Vorbereitung

## Dressing- and Sponge Holding Forceps

### Tupfer- und Schwammzangen



BF112R

BF113R <sup>1/1</sup>

FOERSTER-BALLENGER

BF112R-BF113R

180 mm, 7"

<sup>1/2</sup>

BF116R

BF118R <sup>1/1</sup>

RAMPLEY

BF116R-BF118R

180 mm, 7"

250 mm, 9 3/4"

BF120R

BF121R

smooth jaws  
glattes Maul

smooth jaws  
glattes Maul

FOERSTER-BALLENGER

BF120R-BF123R

245 mm, 9 5/8"

BF122R

BF123R <sup>1/1</sup>

Preparation  
Vorbereitung

# Patient Preparation - Patienten-Vorbereitung

## Tubing Clamps

### Schlauchklemmen

- heavy pattern, long ratchet, therefore passage adjustable
- starkes Modell, lange Sperre, daher Durchlauf dosierbar

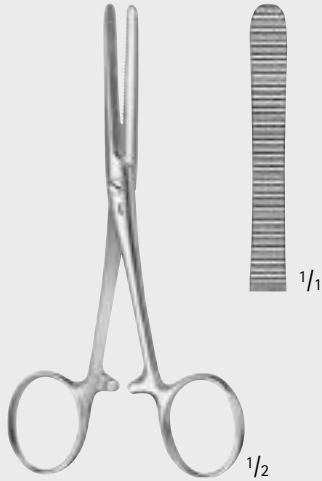

PEAN

**BH410R**

125 mm, 5"



KLINIKUM BERLIN

**AN908R**

145 mm, 5 3/4"



**AN909R**

especially heavy pattern

sehr starkes Modell

165 mm, 6 1/2"



smooth jaw  
glattes Maul



**AN910R**

especially heavy pattern

sehr starkes Modell

165 mm, 6 1/2"



serrated jaw  
geriefes Maul

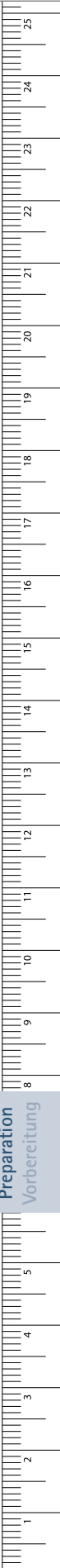

Preparation  
Vorbereitung

MILLIMETERS

# Patient Preparation – Patienten-Vorbereitung

## Tubing Clamps

### Schlauchklemmen

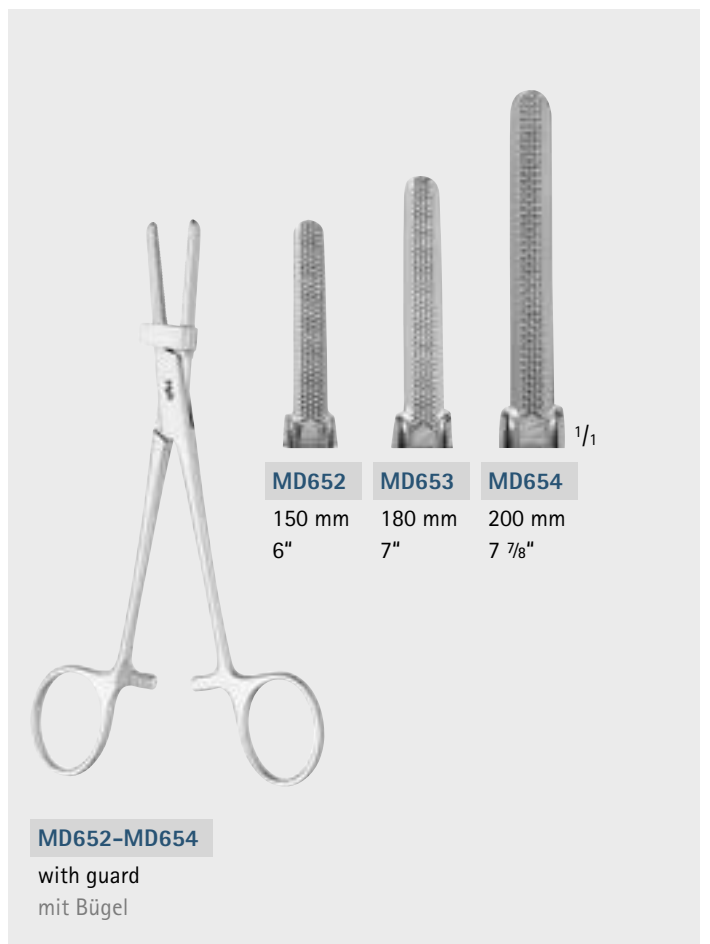
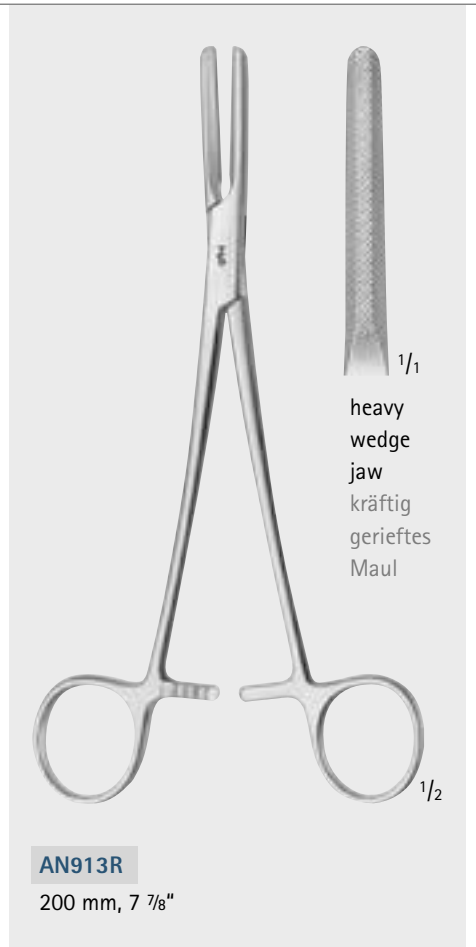
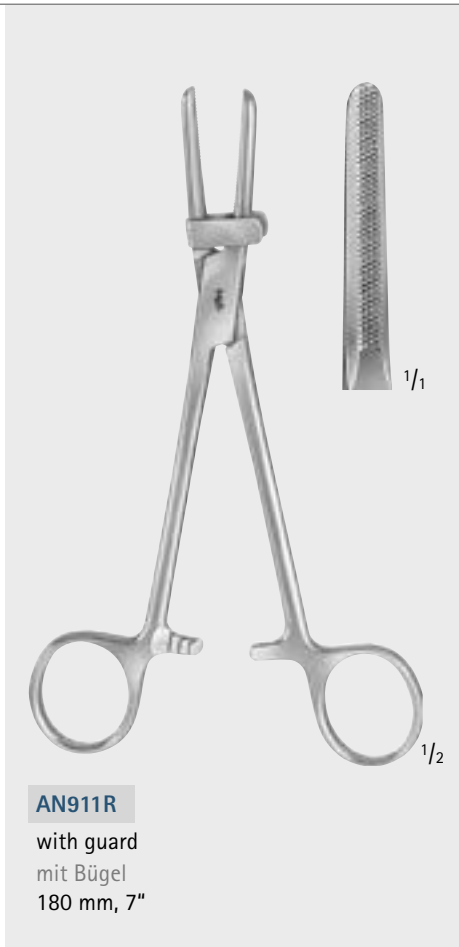
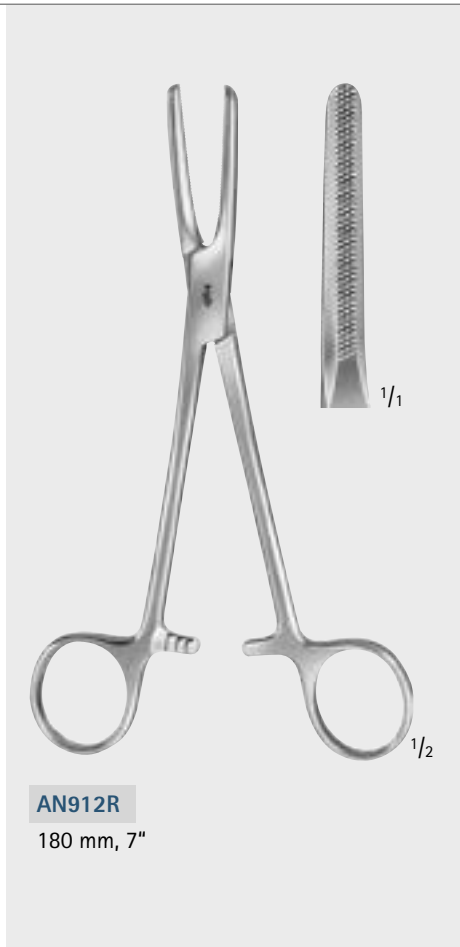

# Patient Preparation - Patienten-Vorbereitung

## Towel Clamps

## Tuchklemmen

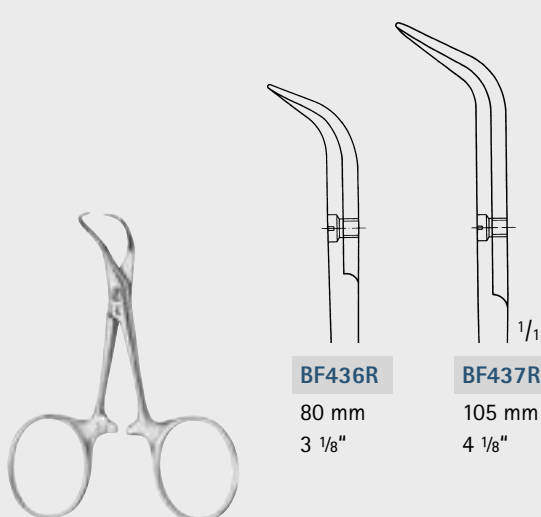

Two Backhaus towel clamps are shown. The first is BF436R, with a length of 80 mm (3 1/8"). The second is BF437R, with a length of 105 mm (4 1/8"). Both have curved tips and a locking mechanism. A 1/1 scale bar is shown next to the BF437R model.

**BACKHAUS**  
**BF436R-BF437R**

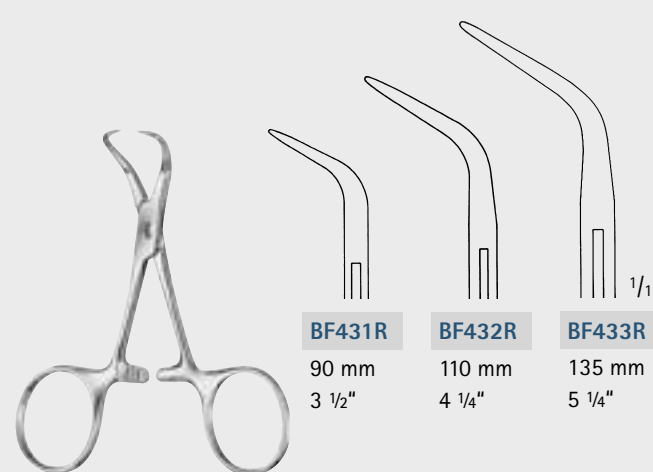

Three Backhaus towel clamps are shown. The first is BF431R, with a length of 90 mm (3 1/2"). The second is BF432R, with a length of 110 mm (4 1/4"). The third is BF433R, with a length of 135 mm (5 1/4"). All have curved tips and a locking mechanism. A 1/1 scale bar is shown next to the BF433R model.

**BACKHAUS**  
**BF431R-BF433R**

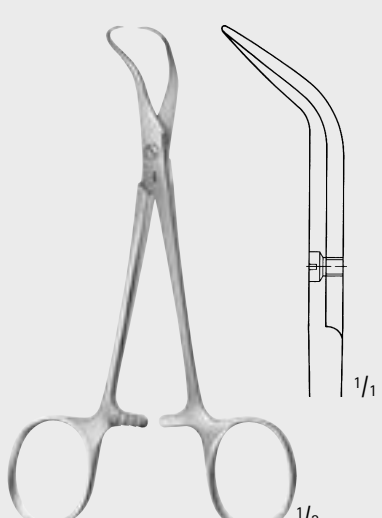

A Backhaus-Kocher towel clamp is shown, model BF444R, with a length of 135 mm (5 1/4"). It has a long, thin, curved tip and a locking mechanism. A 1/1 scale bar is shown next to the tip.

**BACKHAUS-KOCHER**  
**BF444R**  
135 mm, 5 1/4"

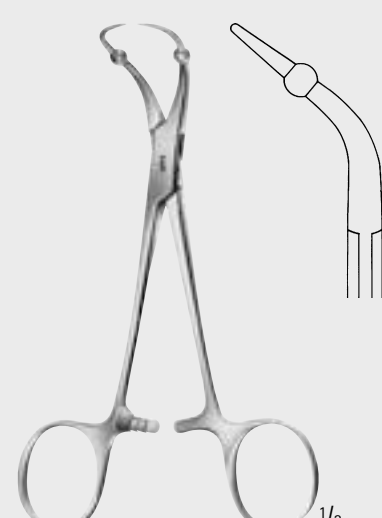

A Roeder towel clamp is shown, model BF448R, with a length of 135 mm (5 1/4"). It has a curved tip with a small circular detail and a locking mechanism. A 1/1 scale bar is shown next to the tip.

**ROEDER**  
**BF448R**  
135 mm, 5 1/4"

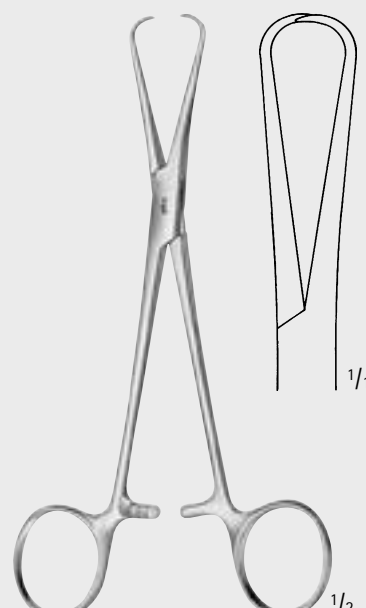

A Bernhard towel clamp is shown, model BF426R, with a length of 160 mm (6 1/4"). It has a long, thin, curved tip and a locking mechanism. A 1/1 scale bar is shown next to the tip.

**BERNHARD**  
**BF426R**  
160 mm, 6 1/4"

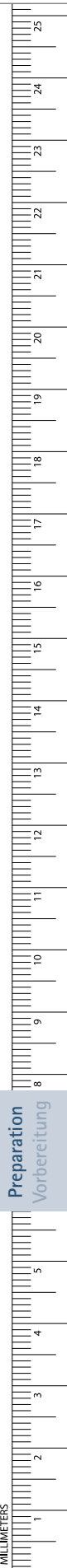

## Patient Preparation – Patienten-Vorbereitung

### Towel Clamps

### Tuchklemmen

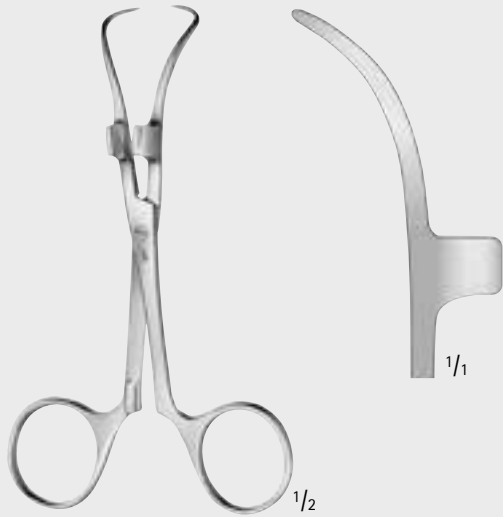
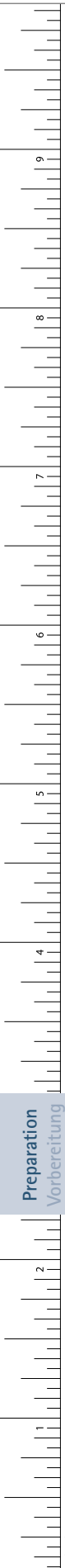

ROBIN

**BF439R**

with holders  
for cable up to 5 mm  
mit Kabelhalterung  
bis 5 mm Kabelstärke  
135 mm, 5 1/4"

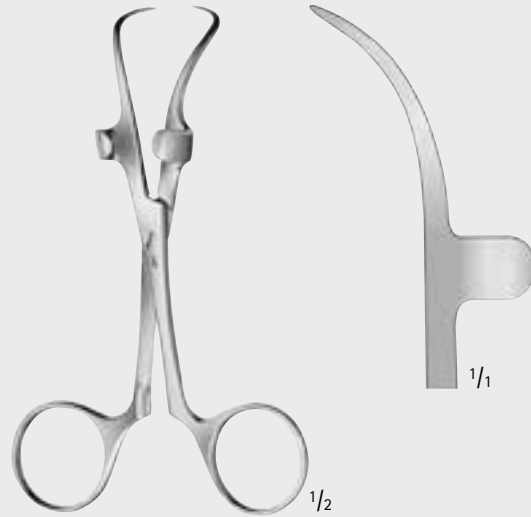

ROBIN

**BF440R**

with holders  
for tubing up to 13 mm  
mit Schlauchhalterung  
bis 13 mm Schlauchstärke  
135 mm, 5 1/4"

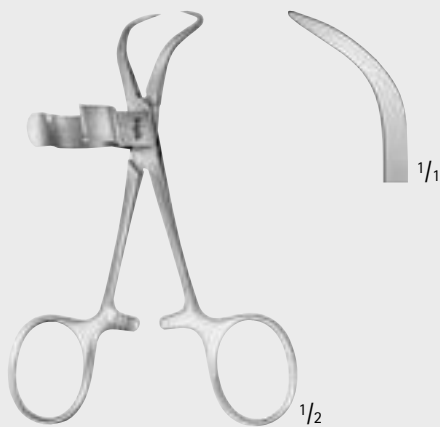

**BF442R**

with holders for tubing up to 15 mm  
mit Schlauchhalterung bis  
15 mm Schlauchstärke  
110 mm, 4 1/4"

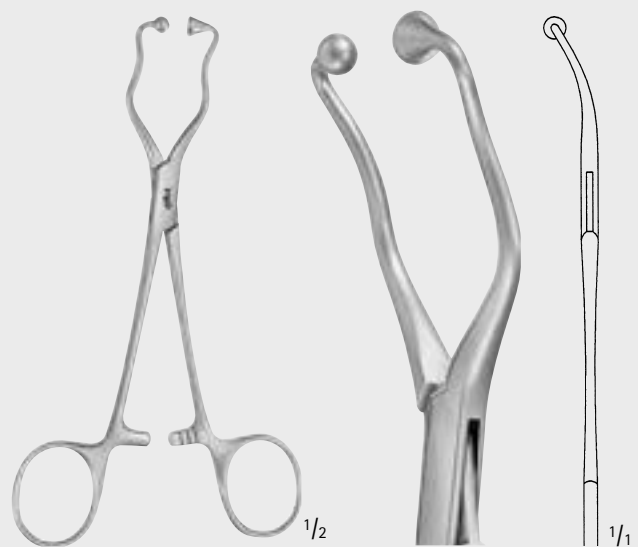

**BF443R**

Tube fixation forceps with  
atraumatic jaw parts  
Doppelschlauch-Fixierklemme  
atraumatische Fassfläche  
140 mm, 5 1/2"

# Patient Preparation - Patienten-Vorbereitung

## Towel Clamps

## Tuchklemmen

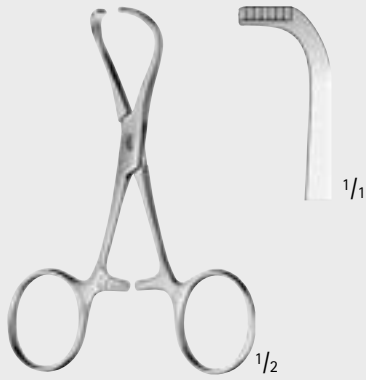

LORNA

**BF461R**

non-perforating  
nicht perforierend  
95 mm, 3 3/4"

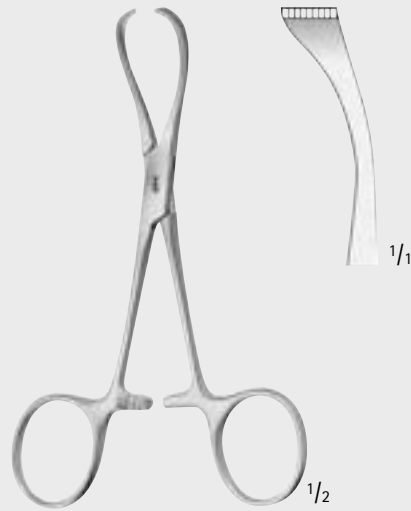

LORNA

**BF463R**

non-perforating  
nicht perforierend  
130 mm, 5 1/8"

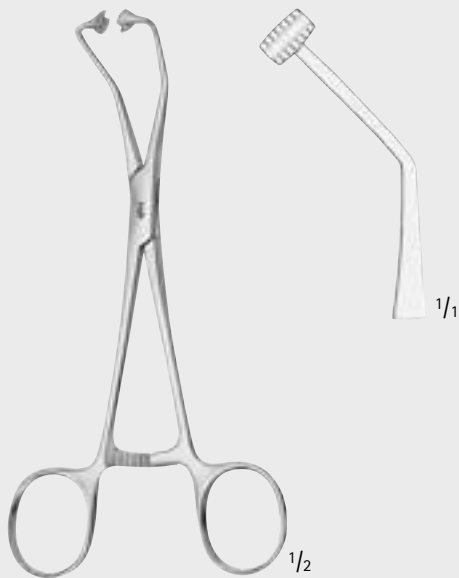

**BF460R**

for paper drapes  
für Papiertücher  
150 mm, 6"

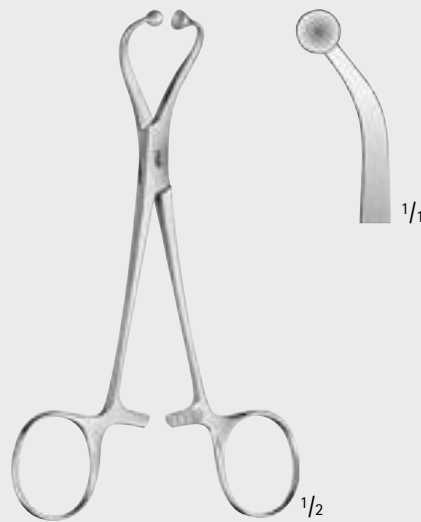

**BF464R**

for paper drapes  
für Papiertücher  
140 mm, 5 1/2"

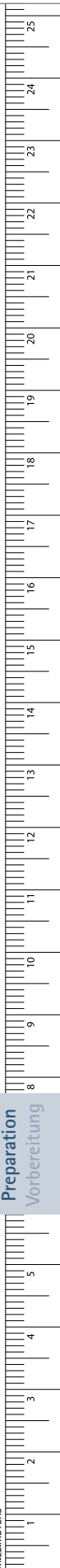

Preparation  
Vorbereitung

# Patient Preparation – Patienten-Vorbereitung

## Towel Clamps

## Tuchklemmen

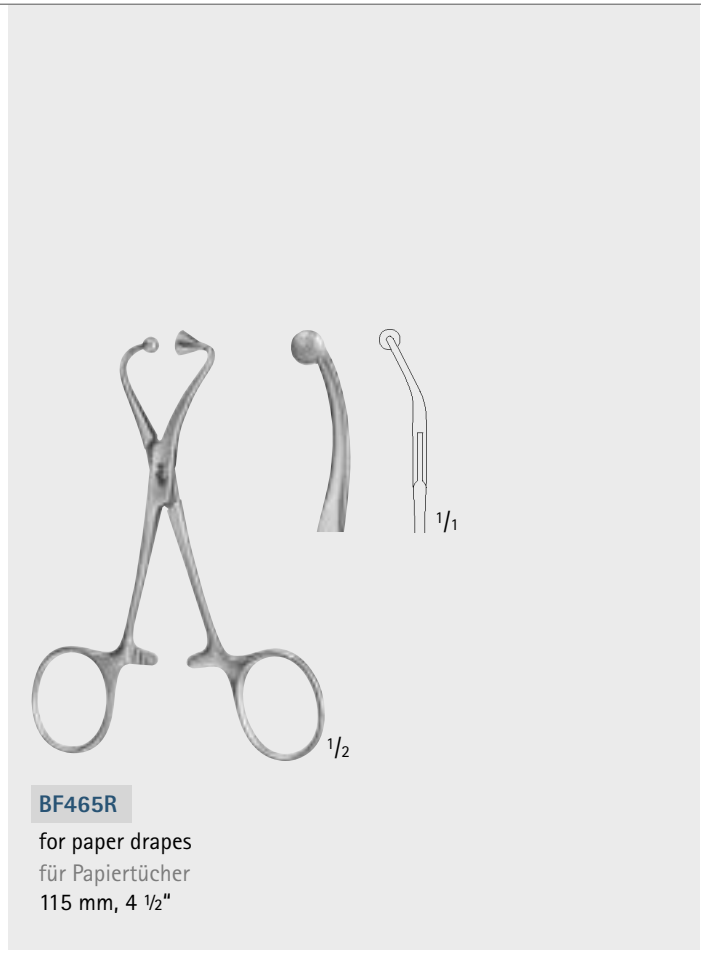

**BF465R**

for paper drapes  
für Papiertücher  
115 mm, 4 1/2"

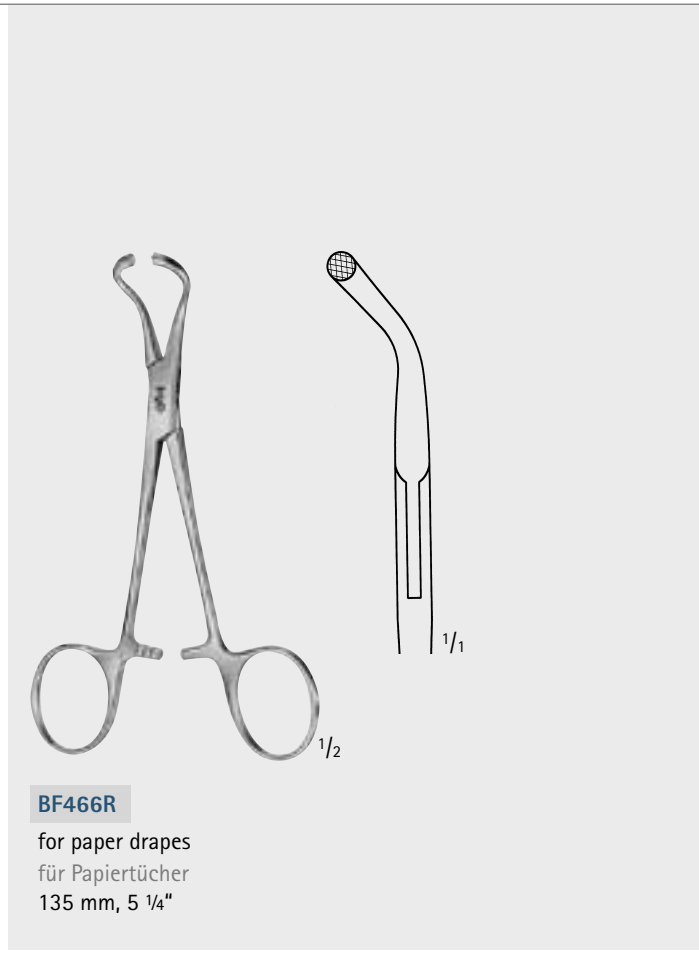

**BF466R**

for paper drapes  
für Papiertücher  
135 mm, 5 1/4"

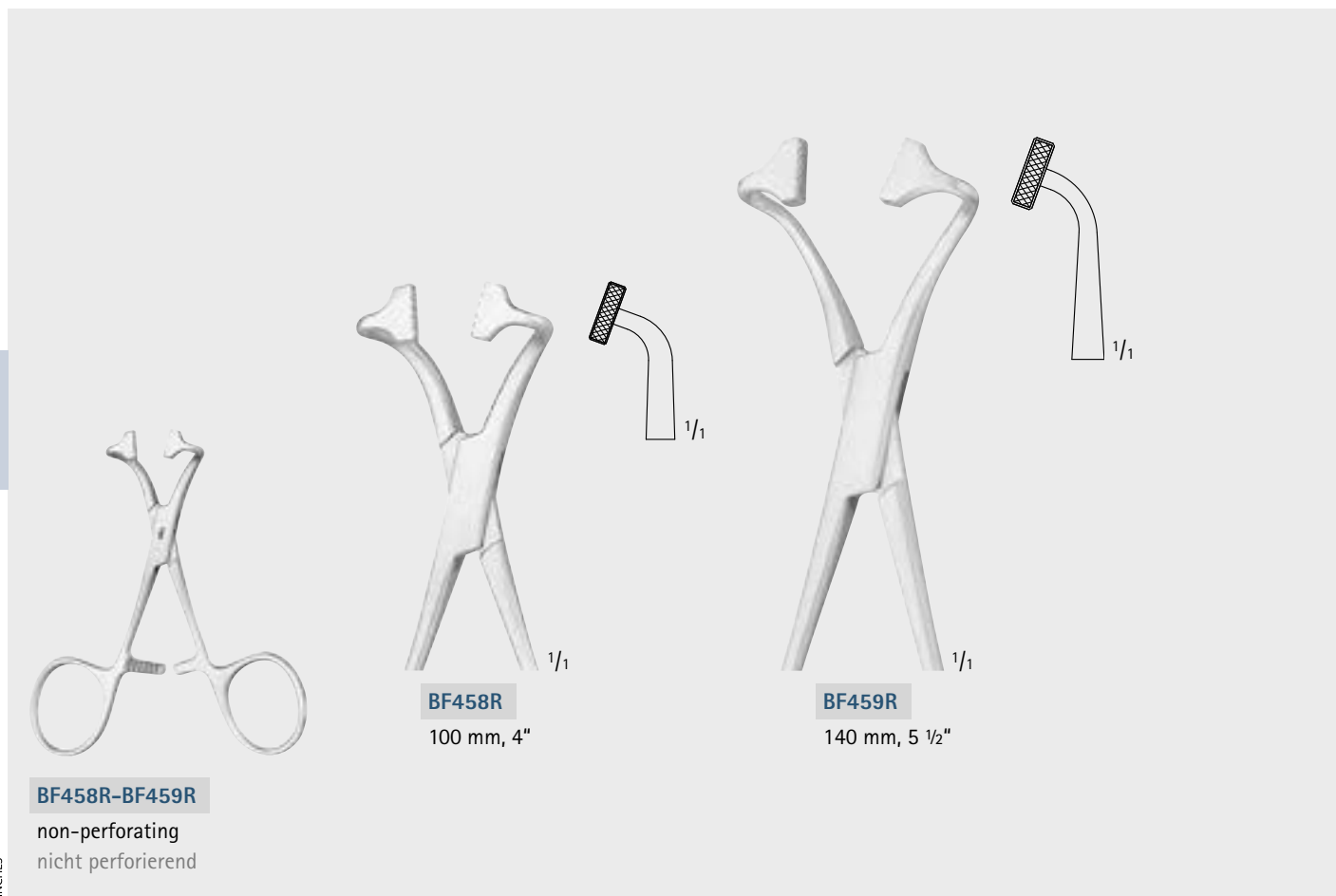

**BF458R**

100 mm, 4"

**BF459R**

140 mm, 5 1/2"

**BF458R-BF459R**

non-perforating  
nicht perforierend

Preparation  
Vorbereitung



# Patient Preparation – Patienten-Vorbereitung

## Catheter Introducing Forceps

### Kathetereinführungszangen



MAGILL

AN379R-AN381R



**AN379R**

for infants  
für Kleinkinder  
150 mm, 6"

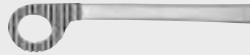

**AN380R**

for children  
für Kinder  
200 mm, 7 7/8"



**AN381R**

for adults  
für Erwachsene  
250 mm, 9 3/4"

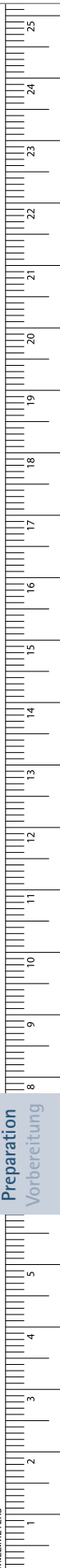

Preparation  
Vorbereitung

## Patient Preparation – Patienten-Vorbereitung

### Steel Ruler, Calipers

### Stahlmaßstab, Messzirkel, Messschieber



Art. No. Art. Nr.	Length Länge
<b>AA804R</b>	150 mm, 6"
<b>AA805R</b>	300 mm, 11 3/4"
<b>AA806R</b>	500 mm, 19 3/4"

Steel ruler, stainless, graduated in millimeters and inches  
Stahlmaßstab, nichtrostend, Millimeter- und Zolleinteilung



**CASTROVIEJO**

**OB792R**  
Caliper, measuring range 0-15 mm  
Messzirkel, Messbereich 0-15 mm  
75 mm, 3"



**OB793R**

Caliper, measuring range 0-40 mm  
Messzirkel, Messbereich 0-40 mm  
170 mm, 6 3/4"



**AA845R**

Special caliper, measuring range up to 150 mm  
Spezial-Messschieber, Messbereich bis 150 mm  
225 mm, 8 7/8"



**AA846R**

Caliper, measuring range up to 150 mm  
Messschieber, Messbereich bis 150 mm  
230 mm, 9"



**AA847R**

Caliper, measuring range up to 100 mm  
Messschieber, Messbereich bis 100 mm  
130 mm, 5 1/8"

Preparation  
Vorbereitung

INCHES

## General Surgical Instruments Chirurgische Instrumente

- Scalpels
- Skalpelle

# Scalpels - Skalpelle

## Safety Scalpels

### Sicherheitskalpelle

#### Single Use

sterile

steril

**BA810SU-BA836SU**

Carbon Steel

Sales unit:

PAK = Package of 10 pieces

Bestelleinheit:

PAK = Packung à 10 Stück



**BA810SU**

Fig. 10



**BA811SU**

Fig. 11



**BA812SU**

Fig. 12



**BA813SU**

Fig. 13



**BA815SU**

Fig. 15



**BA815-1SU**

Fig. 15-1



**BA815-CSU**

Fig. 15-C



**BA818SU**

Fig. 18

Scalpels  
Skalpelle

INCHES

# Scalpels – Skalpelle

## Safety Scalpels

### Sicherheitskalpelle

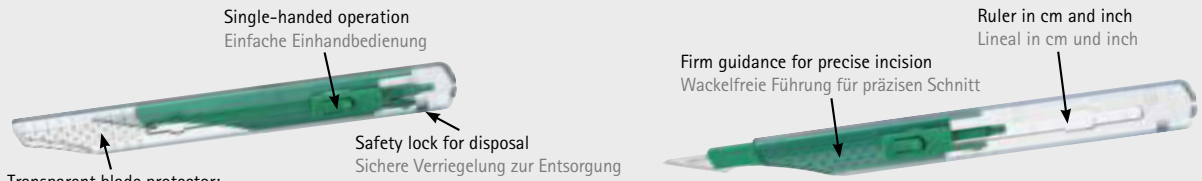

Transparent blade protector:

- Blade shape is visible
- Position of blade is always evident

Transparenter Klingenschutz:

- Klingenfigur ist sichtbar
- Position der Klinge jederzeit erkennbar



**BA819SU**

Fig. 19



**BA820SU**

Fig. 20



**BA821SU**

Fig. 21



**BA822SU**

Fig. 22



**BA823SU**

Fig. 23



**BA824SU**

Fig. 24



**BA825SU**

Fig. 25



**BA836SU**

Fig. 36

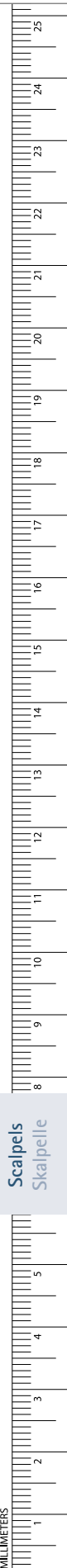

Scalpels  
Skalpelle

MILLIMETERS

# Scalpels - Skalpelle

## Single Use Scalpels

### Einmalskalpelle

sterile  
steril

**BA210-BA224 / 5518016-5518105**

Sales unit:

PAK = Package of 10 pieces

Bestelleinheit:

PAK = Packung à 10 Stück



1/1

Carbon Steel **BA210**

Stainless Steel **5518059**

Fig. 10



1/1

**BA211**

**5518040**

Fig. 11



1/1

**BA212**

**5518105**

Fig. 12



1/1

**BA215**

**5518032**

Fig. 15



1/1

**BA215-1**

Fig. 15-1



1/1

**BA215-C**

Fig. 15-C



1/1

**BA218**

Fig. 18

Scalpels  
Skalpelle

INCHES

# Scalpels – Skalpelle

## Single Use Scalpels

### Einmalskalpelle

sterile  
steril

Transparent full-protection cover

- The blade is completely covered to prevent injuries

Transparentes Vollschutzcover

- Die Klinge ist komplett geschützt



1/1

Carbon Steel **BA219**  
Stainless Steel

Fig. 19



1/1

**BA220**  
**5518067**

Fig. 20



1/1

**BA221**  
**5518075**

Fig. 21



1/1

**BA222**  
**5518083**

Fig. 22



1/1

**BA223**  
**5518016**

Fig. 23



1/1

**BA224**  
**5518091**

Fig. 24

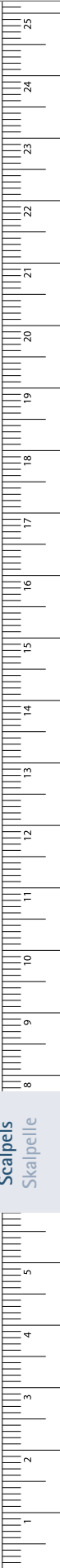

# Scalpels - Skalpelle

## Single Use Scalpels

### Einmalskalpelle



sterile / steril

#### BA311SU-BA323SU

Sales unit:

PAK = Package of 10 pieces

Bestelleinheit:

PAK = Packung à 10 Stück

sterile / steril

#### BA364-BA367

Sales unit:

PAK = Package of 5 pieces

Bestelleinheit:

PAK = Packung à 5 Stück



**BA311SU**

Fig. 11  
230 mm, 9"



**BA323SU**

Fig. 23  
230 mm, 9"



**BA364**

165 mm, 6 1/2"



**BA365**

165 mm, 6 1/2"

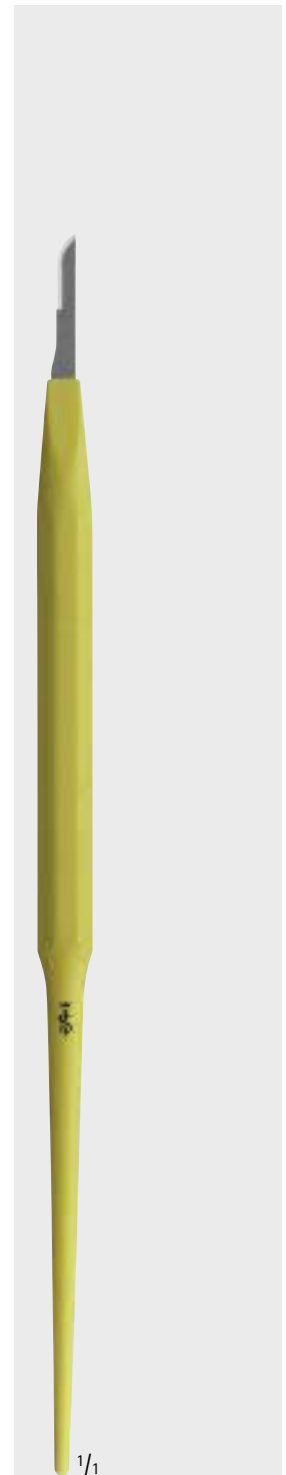

**BA367**

165 mm, 6 1/2"

Scalpels  
Skalpelle



# Scalpels – Skalpelle

## Scalpel Handles

### Skalpellgriffe

For blades fig. 10 - 15 and fig. 40, 42 / Für Klingen Fig. 10 - 15 und Fig. 40, 42



<sup>1</sup>/<sub>1</sub>  
BARRON

**BBO68R**

130 mm, 5 1/8"



<sup>1</sup>/<sub>1</sub>  
BB073R

**BB073R**

No. 3  
125 mm, 5"



<sup>1</sup>/<sub>1</sub>  
BB074R

**BB074R**

No. 3  
with cm / inch scale  
cm / inch graduiert  
125 mm, 5"



<sup>1</sup>/<sub>1</sub>  
BB075R

**BB075R**

No. 3 L  
210 mm, 8 1/4"

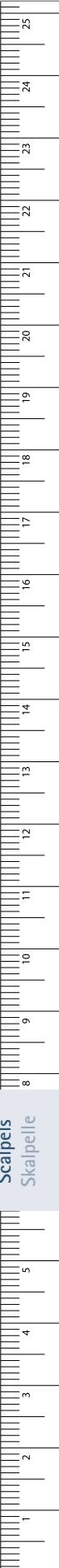

# Scalpels - Skalpelle

## Scalpel Handles

### Skalpellgriffe

For blades fig. 10 - 15 and fig. 40, 42 / Für Klingen Fig. 10 - 15 und Fig. 40, 42

corresponds with english No. 5  
entspricht der englischen Nr. 5



**BB077R**  
No. 7  
160 mm, 6 1/4"



**BB078R**  
225 mm, 8 7/8"



**BB079R**  
225 mm, 8 7/8"



**BB071R**  
210 mm, 8 1/4"



**BB070R**  
155 mm, 6 1/8"



**BB063R**  
145 mm, 5 3/4"

Scalpels  
Skalpelle

INCHES

# Scalpels – Skalpelle

## Scalpel Handles

### Skalpellgriffe

For blades fig. 18 - 36 / Für Klingen Fig. 18 - 36



**BB084R**

No. 4  
135 mm, 5 1/4"



**BB085R**

No. 4 L  
215 mm, 8 1/2"



**BB080R**

No. 4  
225 mm, 8 7/8"



**BB088R**

No. 8  
130 mm, 5 1/8"



**BB089R**

145 mm, 5 3/4"

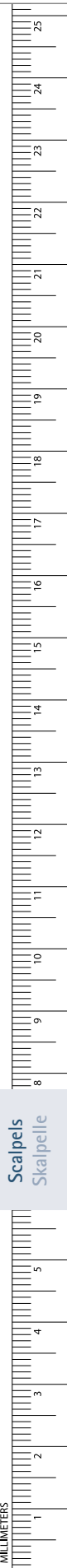

Scalpels  
Skalpelle

MILLIMETERS

# Scalpels – Skalpelle

## Sterile Scalpel Blades

### Sterilklingen

**BB510-BB542 / 16600495-16615492**

Sterile scalpel blades  
fitting handles on page 363 and 364

Sales unit:  
PAK = Package of 100 pieces  
in dispenser package

Sterilklingen  
passend zu den Griffen auf Seite 363 und 364

Bestelleinheit:  
PAK = Packung à 100 Stück  
in Spenderpackung



1/1

Carbon Steel **BB510**  
Stainless Steel **16600495**  
Fig. 10



1/1

**BB511**  
**16600509**  
Fig. 11



1/1

**BB512**  
**16600517**  
Fig. 12



1/1

**BB513**  
**16615492**  
Fig. 13



1/1

Carbon Steel **BB515**  
Stainless Steel **16600525**  
Fig. 15



1/1

**BB515-1**  
Fig. 15-1



1/1

**BB515-C**  
Fig. 15-C



1/1

**BB540**  
Fig. 40  
double cutting  
doppelschneidig



1/1

**BB542**  
Fig. 42  
double cutting  
doppelschneidig

Scalpels  
Skalpelle

INCHES

# Scalpels – Skalpelle

## Sterile Scalpel Blades, Stitch Cutter

### Sterilklingen, Fadenmesser

**BB518-BB536 / 16600541-16616634**

Sterile scalpel blades  
 fitting handles on page 365  
 Sales unit:  
 PAK = Package of 100 pieces  
 in dispenser package  
 Sterilklingen  
 passend zu den Griffen auf Seite 365  
 Bestelleinheit:  
 PAK = Packung à 100 Stück  
 in Spenderpackung



1/1

Carbon Steel **BB518**  
 Stainless Steel **16600541**  
 Fig. 18



1/1

**BB519**  
 Fig. 19



1/1

**BB520**  
**16600550**  
 Fig. 20



1/1

**BB521**  
**16600568**  
 Fig. 21



1/1

Carbon Steel **BB522**  
 Stainless Steel **16600576**  
 Fig. 22



1/1

**BB523**  
**16600584**  
 Fig. 23



1/1

**BB524**  
**16600592**  
 Fig. 24



1/1

**BB525**  
**16616634**  
 Fig. 25



1/1

**BB536**  
**16615522**  
 Fig. 36



1/1

Stitch cutter  
 Sales unit:  
 PAK = Package of 100 pieces  
 Fadenmesser  
 Bestelleinheit:  
 PAK = Packung à 100 Stück

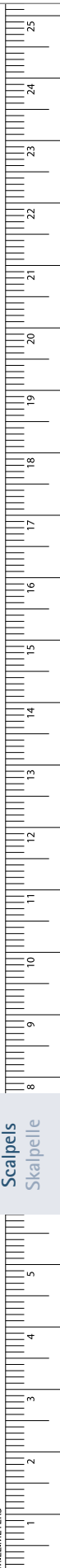

# Scalpels - Skalpelle

## Scalpel Handles for Microsurgery Blades

## Skalpellgriffe für mikrochirurgische Klingen



Scalpels  
Skalpelle

- Titanium
- Titan

- ERGOPLANT



**BB045T**

145 mm, 5 3/4"



**DX305R**

150 mm, 6"



**BB046R**

135 mm, 5 1/4"



**BB048R**

155 mm, 6 1/8"



**CASPAR**

**BB052R**

180 mm, 7"



**BB054R**

200 mm, 7 7/8"

## Scalpels – Skalpelle

### Scalpel Handle for Microsurgery Blades – Microsurgery Blades

### Skalpellgriff für mikrochirurgische Klingen – Mikrochirurgische Klingen

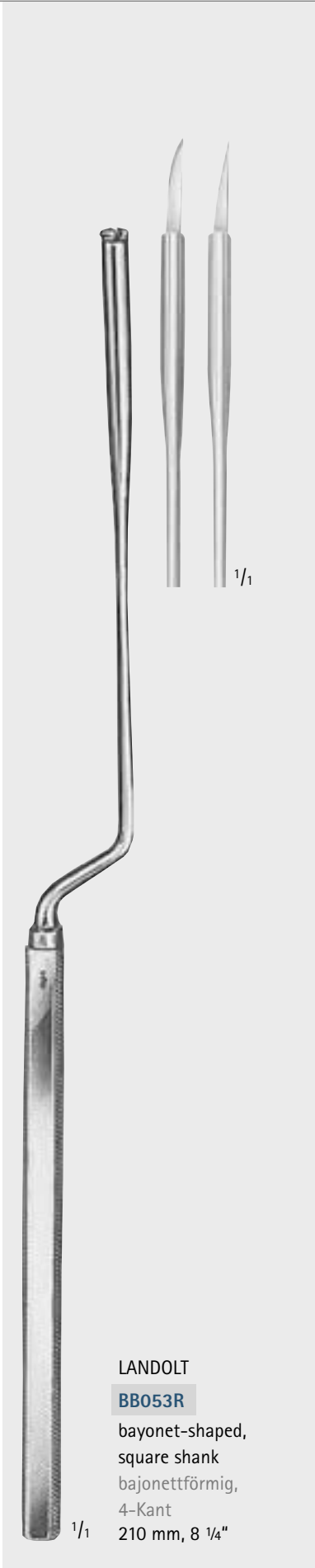

LANDOLT

**BB053R**

bayonet-shaped,  
square shank  
bajonettförmig,  
4-Kant  
210 mm, 8 1/4"

1/1



1/1

YASARGIL

**BB331R**

Arachnoid blade, diam. 1.5 mm

Sales unit:

PAK = Package of 10 pieces

Tellermesser, Ø 1,5 mm

Bestelleinheit

PAK = Packung à 10 Stück



1/1

YASARGIL

**BB332R**

Arachnoid blade, diam. 2.5 mm

Sales unit:

PAK = Package of 10 pieces

Tellermesser, Ø 2,5 mm

Bestelleinheit

PAK = Packung à 10 Stück



1/1

**BB361R**

PAK =

Package of 10 pieces

Packung à 10 Stück



1/1

**BB362R**

PAK =

Package of 10 pieces

Packung à 10 Stück



1/1

**BB363R**

ST =

Package of 1 piece

Packung à 1 Stück



1/1

**BB364R**

PAK =

Package of 10 pieces

Packung à 10 Stück



1/1

**BB365R**

PAK =

Package of 10 pieces

Packung à 10 Stück



1/1

**BB367R**

PAK =

Package of 10 pieces

Packung à 10 Stück



1/1

**BB368R**

PAK =

Package of 10 pieces

Packung à 10 Stück



1/1

**BB369R**

ST =

Package of 1 piece

Packung à 1 Stück

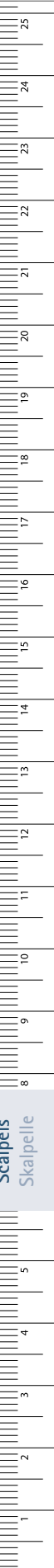

Scalpels  
Skalpelle

MILLIMETERS

## Scalpels – Skalpelle

### Diamond Knives

### Diamant-Messer

Diamond Knife  
Diamant-Messer

REM view of a common scalpel blade  
REM Vergrößerung einer gängigen Skalpellklinge

REM view of a diamond knife blade  
REM Vergrößerung einer Diamant-Messerklinge

- Blade made of natural diamond  
Klinge aus Naturdiamant
  - Superior mechanical stability and elasticity of the blade  
Hohe mechanische Stabilität und Elastizität der Klinge
  - Sustained sharpness  
Lang anhaltende Schärfe
  - Excellently clean, precise and force-free incisions  
Hochgradig saubere, präzise und kraftlose Schnitte
  - Protection mechanism for safe storage of the blade inside the handle  
Schutzmechanismus zur sicheren Lagerung der Schneideklinge im Griff
  - Color coded TITANIUM handles  
Kodierung durch farbige Titan Handgriffe
  - Four different cutting geometries:
    - round, retrograde, wedge or lancet blade
- Vier verschiedene Schneidegeometrien:
- Rund-, Retrograd-, Keil-, und Lanzettenklinge

#### Diamond knives

- Due to the properties of their unique blade material, diamond knives offer excellent cutting characteristics for highly clean, precise and force-free incisions.

#### Diamantmesser

- Diamantmesser haben aufgrund ihrer Materialeigenschaften hervorragende Schneideigenschaften, welche sich durch hochgradig saubere, präzise und kraftlose Schnitte auszeichnen.



## Scalpels – Skalpelle

Diamond Knives

Diamant-Messer



**FD113D**

Round blade,  
gold-colored, 7 facets  
Rund-Klinge,  
Gold, 7 Facetten  
1/1 205 mm, 8"



**FD114D** 60°

Retro blade,  
copper-colored  
Retro-Klinge,  
Kupfer  
1/1 205 mm, 8"



**FD115D** 45°

Wedge blade,  
black  
Keil-Klinge,  
Schwarz  
1/1 205 mm, 8"



**FD116D** 60°

Lancet blade,  
bronze-colored  
Lanzetten-Klinge,  
Bronze  
1/1 205 mm, 8"

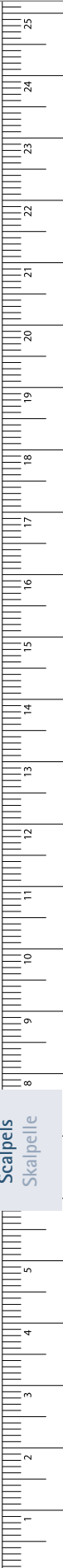

Scalpels  
Skalpelle

MILLIMETERS

# Scalpels - Skalpelle



Scalpels  
Skalpelle

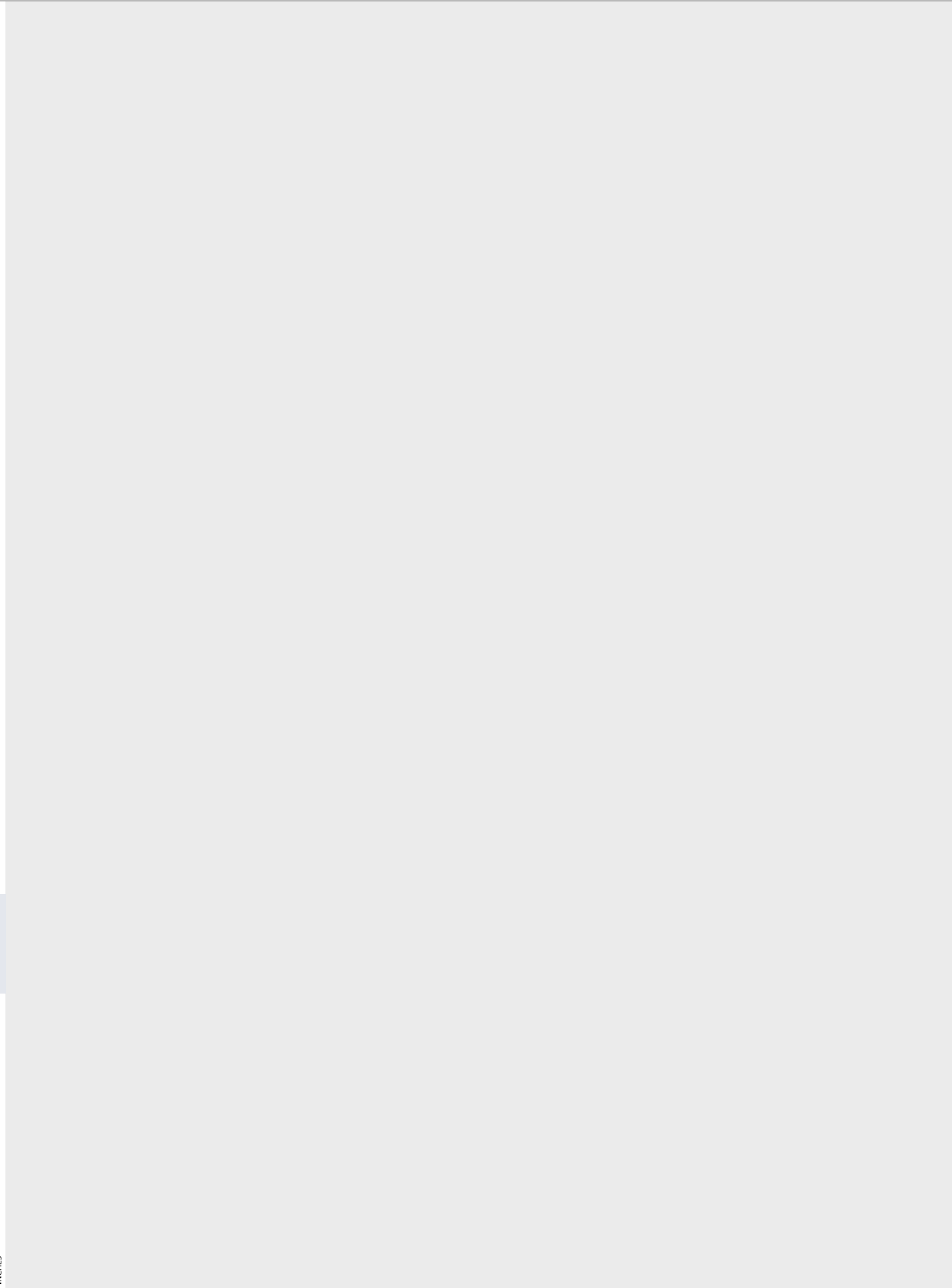

## General Surgical Instruments Chirurgische Instrumente

- Scissors
- Scheren

## Scissors – Scheren

### Noir® Dissecting Scissors

### Noir® Präparierscheren

## Noir®

The special qualities of the Noir® dissecting scissors allow dissection that is finer than ever before. Noir®. Gentle dissection with minimum use of force.

- Soft but sharp.
- Power with minimum force.
- Pure performance.

The combination of the renowned Aesculap tungsten carbide technology with the Aesculap® Noir® coating results in an extremely high surface hardness and therefore high wear resistance in daily hospital use.

Die spezielle Eigenschaften der Noir® Präparierscheren ermöglichen ein Präparieren noch feiner und sicherer als je zuvor. Noir®. Schonendes Präparieren mit minimalen Kraftaufwand.

- Sanfte Schärfe.
- Stärke die kaum Kraft braucht.
- Wirkung pur.

Die Verbindung der bewährten Aesculap Hartmetall Technologie mit der Aesculap® Noir® Beschichtung führt zu einer extrem hohen Oberflächenhärte. Noir®. Die Präparierscheren mit der hohen Verschleißbeständigkeit im täglichen Klinikeinsatz.



Microtome edge – the extremely sharp cutting edge of the scissors blade facilitates gentle cutting of tissue with minimal use of force.

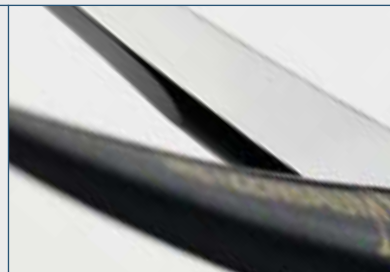

Mikrotomschliff – besonders scharfer Anschliff des Scherenblattes für sanftes Durchtrennen des Gewebes bei minimalem Kraftaufwand.



Wavecut prevents tissue from slipping out during the cutting process.



Wellenschliff verhindert das Herausgleiten des Gewebes während des Schneidens.

# Scissors – Scheren

## Noir® Dissecting Scissors

### Noir® Präparierscheren



- Wavecut prevents tissue from slipping out during the cutting process
- Wellenschliff verhindert das Herausgleiten des Gewebes während des Schneidens

- grazil
- very delicate design
- besonders schlankes Design

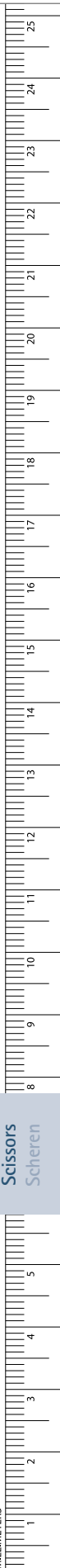

**BC210B-BC211WB**  
110 mm, 4 1/4"

**BC210B**  
straight  
gerade

**BC211B**  
curved  
gebogen

**BC211WB**  
Wavecut curved  
Wellenschliff gebogen

grazil

grazil

1/2

1/1

**BC257B-BC257WB**  
115 mm, 4 1/2"

**BC257B**  
curved  
gebogen

**BC257WB**  
Wavecut curved  
Wellenschliff gebogen

grazil

1/2

1/1

## Scissors – Scheren

### Noir® Dissecting Scissors

### Noir® Präparierscheren



- Wavecut prevents tissue from slipping out during the cutting process
- Wellenschliff verhindert das Herausgleiten des Gewebes während des Schneidens

- grazil  
very delicate design  
besonders schlankes Design

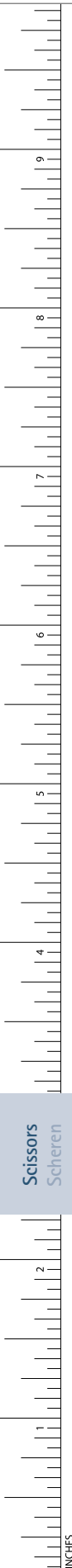

Scissors  
Scheren



BABY-METZENBAUM

BC259B-BC259WB

145 mm, 5 3/4"



BC259B

curved  
gebogen

BC259WB

Wavecut  
curved  
Wellenschliff  
gebogen



METZENBAUM

BC261B-BC261WB

145 mm, 5 3/4"



BC261B

curved  
gebogen

BC261WB

Wavecut  
curved  
Wellenschliff  
gebogen

**Scissors – Scheren**  
 Noir® Dissecting Scissors  
 Noir® Präparierscheren



METZENBAUM

**BC263B-BC271WB**

180 mm, 7"



**BC263B**

curved  
gebogen

**BC263WB**

Wavecut  
curved  
Wellenschliff  
gebogen



**BC271B**

curved  
gebogen

**BC271WB**

Wavecut  
curved  
Wellenschliff  
gebogen



TÖNNIS-ADSON

**BC273B-BC273WB**

175 mm, 6 7/8"



**BC273B**

curved  
gebogen

**BC273WB**

Wavecut  
curved  
Wellenschliff  
gebogen

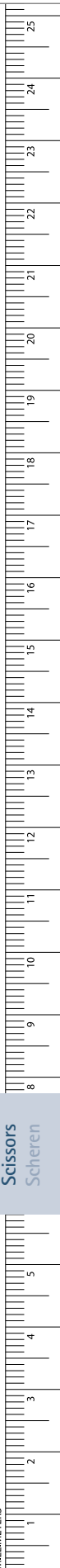

# Scissors – Scheren

## Noir® Dissecting Scissors

## Noir® Präparierscheren



- Wavecut prevents tissue from slipping out during the cutting process
- Wellenschliff verhindert das Herausgleiten des Gewebes während des Schneidens

- grazil  
very delicate design  
besonders schlankes Design



Scissors  
Scheren



**METZENBAUM**  
**BC265B-BC275WB**  
200 mm, 7 7/8"



**grazil**

**BC265B**  
curved  
gebogen

**BC275B**  
curved  
gebogen

**BC265WB**  
Wavecut  
curved  
Wellenschliff  
gebogen

**BC275WB**  
Wavecut  
curved  
Wellenschliff  
gebogen

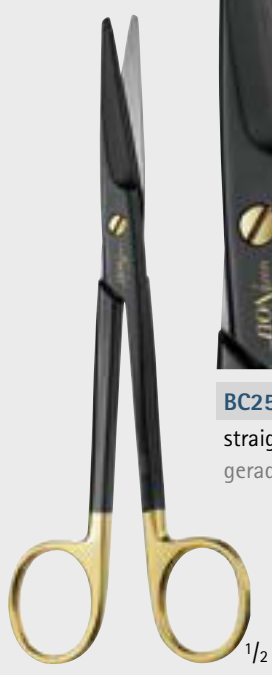

**MAYO**  
**BC252B-BC253WB**  
170 mm, 6 3/4"



**BC252B**  
straight  
gerade

**BC253B**  
curved  
gebogen

**BC253WB**  
Wavecut  
curved  
Wellenschliff  
gebogen



Scissors – Scheren  
 Noir® Dissecting Scissors  
 Noir® Präparierscheren



**BC283B-BC284WB**

165 mm, 6 1/2"



MAYO-LEXER

**BC284B**

curved  
gebogen

MAYO-LEXER

**BC284WB**

Wavecut  
curved  
Wellenschliff  
gebogen

grazil



LEXER

**BC283B**

curved  
gebogen

LEXER

**BC283WB**

Wavecut  
curved  
Wellenschliff  
gebogen

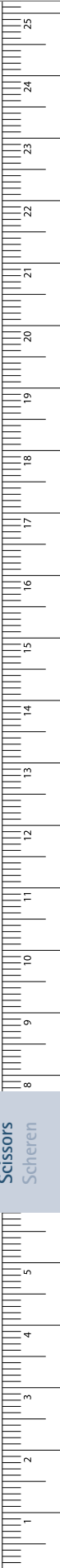

## Scissors – Scheren

### DUROTIP® Delicate Scissors

### DUROTIP® Feine Scheren

- **DUROTIP® Scissors**  
with inserted tungsten carbide cutting edges
  - 3 years guarantee!
  - Excellent cutting accuracy
  - Long working life
  - Gold-plated rings
- **DUROTIP®-Scheren**  
mit eingesetzten Hartmetall-Schneiden
  - 3 Jahre Garantie!
  - Hervorragende Schnitthaltigkeit
  - Lange Lebensdauer
  - Vergoldete Ringe
- **grazil**  
very delicate design  
sehr schlankes Design



BC210R

BC211R

BC210R-BC211R

Ligature scissors  
Fadenscheren  
110 mm, 4 1/4"



1 blade serrated  
1 Schneide gezahnt

GOLDMAN-FOX

DO250R

130 mm, 5 1/8"



DO208R

DO209R

DO208R-DO209R

120 mm, 4 3/4"

Scissors  
Scheren

INCHES

# Scissors – Scheren

DUROTIP® Surgical Scissors

DUROTIP® Chirurgische Scheren

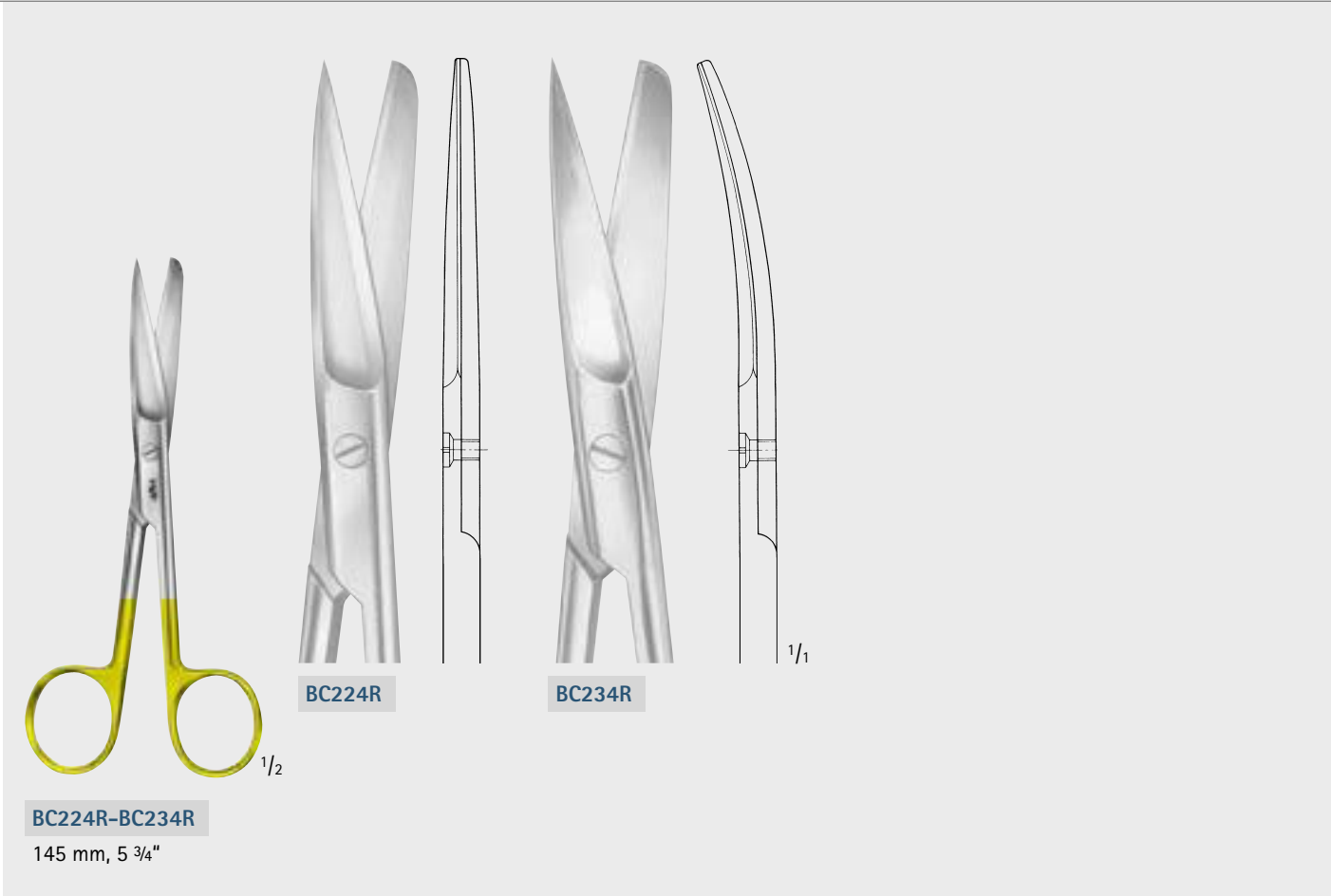

**BC224R-BC234R**

145 mm, 5 3/4"

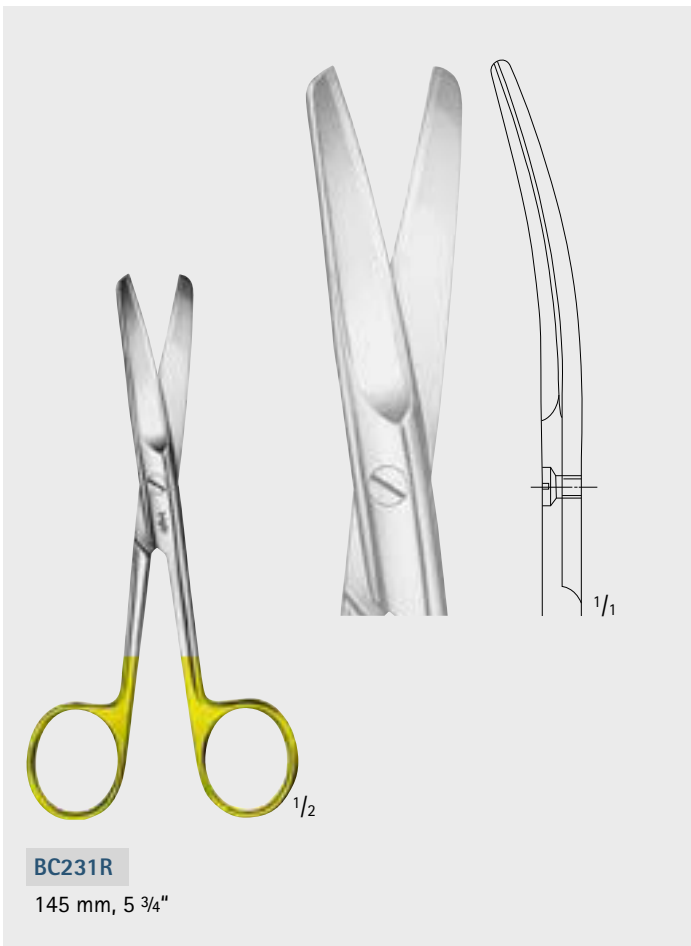

**BC231R**

145 mm, 5 3/4"

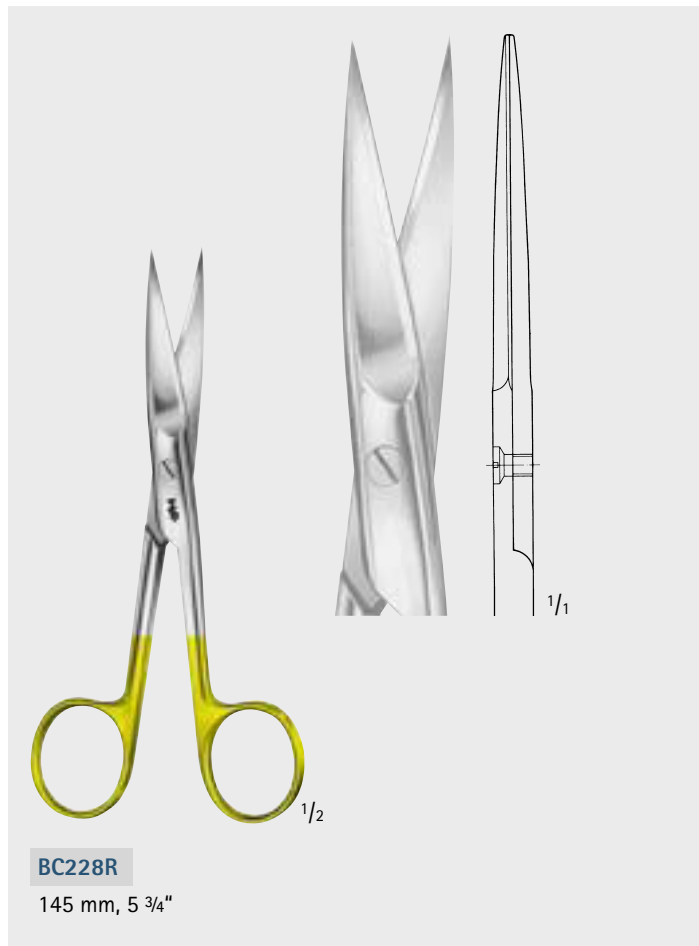

**BC228R**

145 mm, 5 3/4"

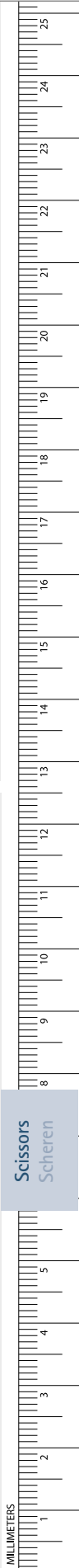

## Scissors – Scheren

### DUROTIP® Dissecting Scissors

### DUROTIP® Präparierscheren



MAYO

**BC250R-BC253R**



**BC250R**

140 mm  
5 1/2"



**BC252R**

170 mm  
6 3/4"



**BC251R**

140 mm  
5 1/2"



**BC253R**

170 mm  
6 3/4"

1/1



MAYO

**BC242R-BC559R**



**BC242R**

170 mm  
6 3/4"



**BC558R**

230 mm  
9"



**BC243R**

170 mm  
6 3/4"



**BC559R**

230 mm  
9"

1/1

Scissors  
Scheren

INCHES

**Scissors – Scheren**  
DUROTIP® Dissecting Scissors  
DUROTIP® Präparierscheren

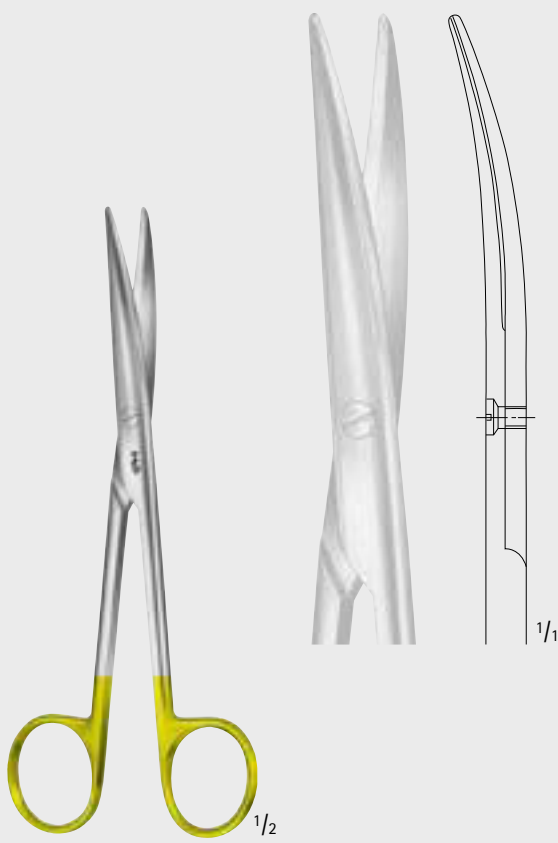

LEXER  
**BC283R**  
narrow  
schmal  
165 mm, 6 1/2"

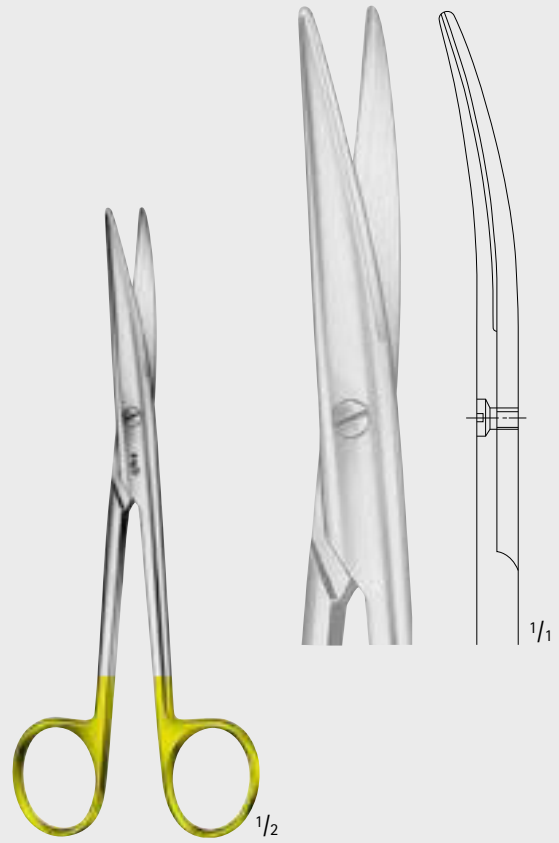

MAYO-LEXER  
**BC284R**  
165 mm, 6 1/2"

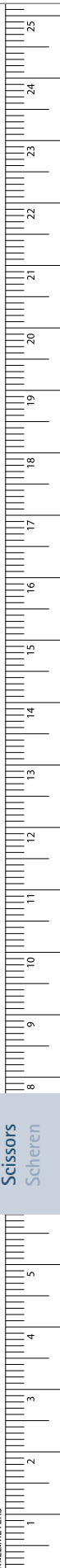

## Scissors – Scheren

DUROTIP® Dissecting Scissors

DUROTIP® Präparierscheren

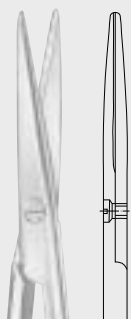

BC256R

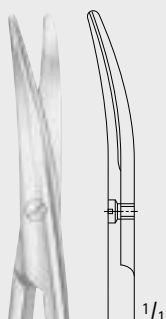

BC257R

BC256R-BC257R

115 mm, 4 1/2"

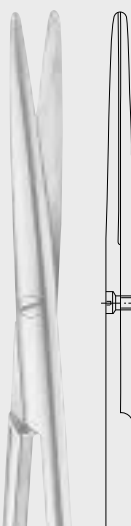

BC258R

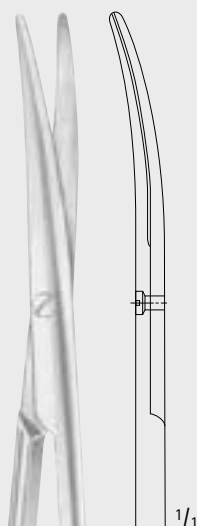

BC259R

BABY-METZENBAUM

BC258R-BC259R

145 mm, 5 3/4"

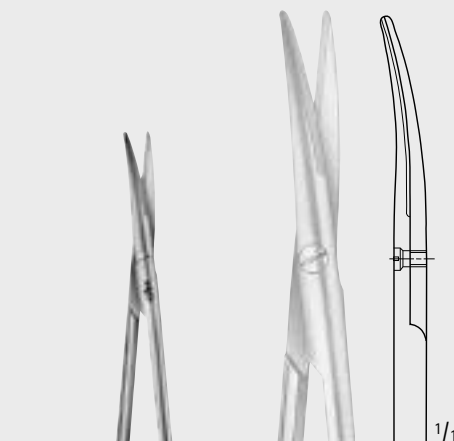

TÖNNIS-ADSON

BC273R

175 mm, 6 7/8"

# Scissors – Scheren

## DUROTIP® Dissecting Scissors

### DUROTIP® Präparierscheren



METZENBAUM

BC260R-BC265R



**BC260R**

145 mm  
5 3/4"

**BC262R**

180 mm  
7"

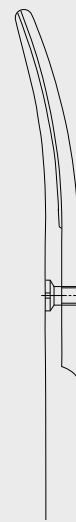

**BC261R**

145 mm  
5 3/4"

**BC263R**

180 mm  
7"

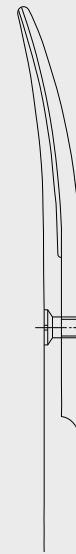

1/1

**BC265R**

200 mm  
7 7/8"



METZENBAUM

BC270R-BC277R



**BC270R**

180 mm  
7"

**BC274R**

200 mm  
7 7/8"

**BC276R**

230 mm  
9"



**BC271R**

180 mm  
7"

**BC275R**

200 mm  
7 7/8"



1/1

**BC277R**

230 mm  
9"

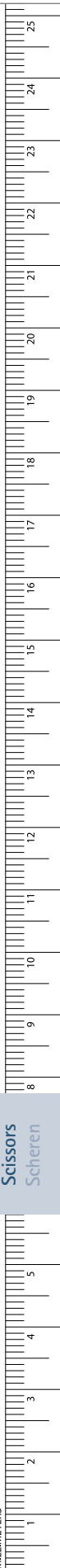

Scissors  
Scheren

MILLIMETERS

## Scissors – Scheren

### DUROTIP® Wavecut Scissors

### DUROTIP® Scheren mit Wellenschliff

Wavecut  
prevents tissue  
from slipping out

Wellenschliff  
verhindert das Herausgleiten  
des Gewebes



W directly after the catalog number  
indicates that the resp. item has one  
serrated cutting edge.

(When ordering please indicate  
together with the catalog number  
e.g. BC211W)

Artikel mit dem W Zusatz sind auf  
einer Schnittfläche mit Wellenschliff  
versehen (bei Bestellungen bitte  
angeben z.B. BC211W)

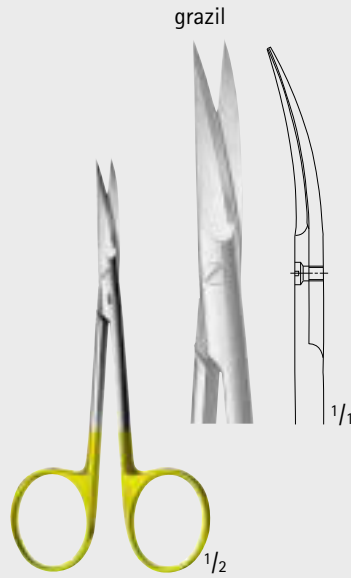

**BC211W**  
Ligature scissors  
Fadenschere  
110 mm, 4 1/4"

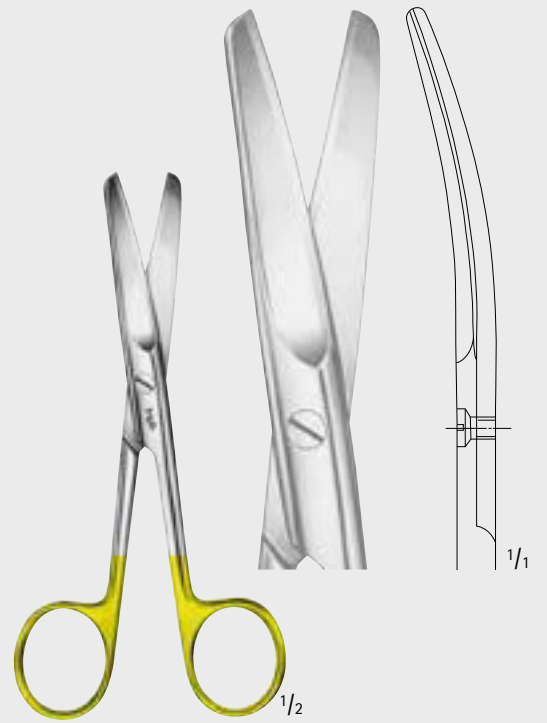

**BC231W**  
Surgical scissors  
Chirurgische Schere  
145 mm, 5 3/4"

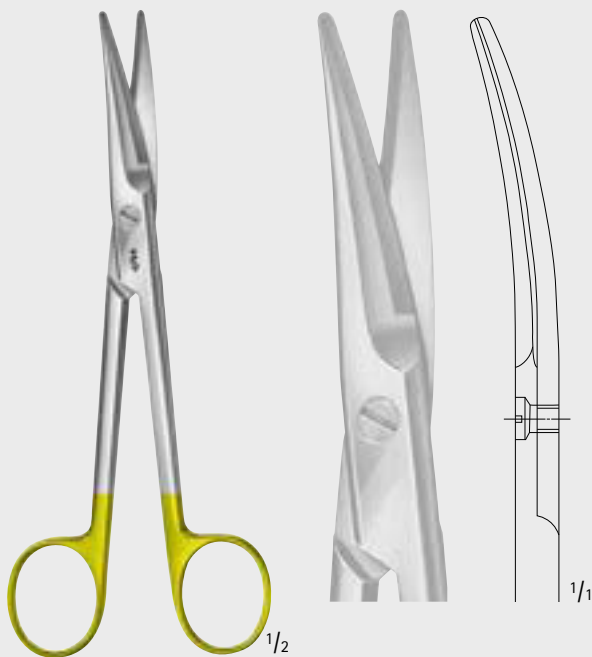

**MAYO**  
**BC253W**  
Dissecting scissors  
Präparierschere  
170 mm, 6 3/4"

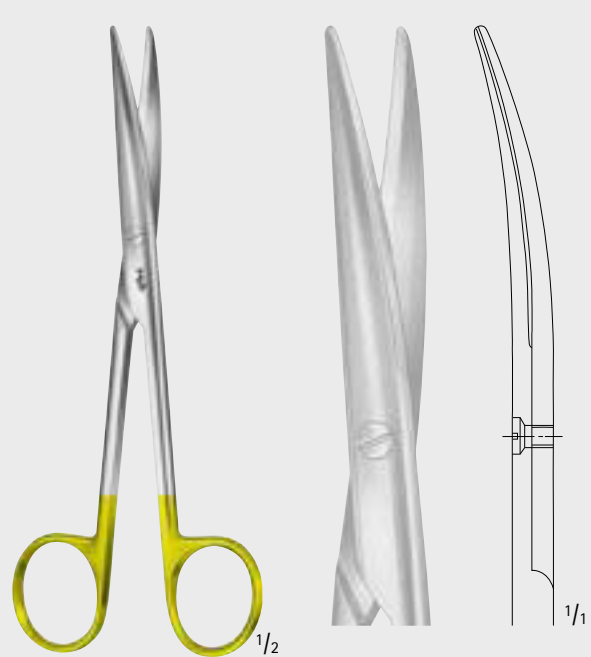

**LEXER**  
**BC283W**  
Dissecting scissors, slender  
Präparierschere, schmal  
165 mm, 6 1/2"



## Scissors – Scheren

DUROTIP® Wavecut Dissecting Scissors

DUROTIP® Präparierscheren mit Wellenschliff

MAYO-LEXER  
**BC284W**  
 165 mm, 6 1/2"

**BC257W**  
 115 mm, 4 1/2"

BABY-METZENBAUM  
**BC259W**  
 145 mm, 5 3/4"

TÖNNIS-ADSON  
**BC273W**  
 175 mm, 6 7/8"

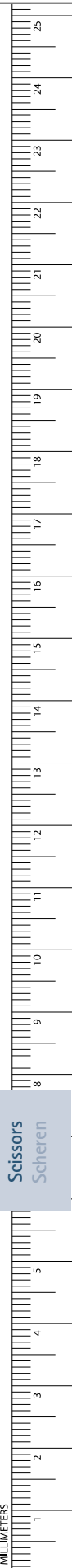

## Scissors – Scheren

### DUROTIP® Wavecut Dissecting Scissors

### DUROTIP® Präparierscheren mit Wellenschliff



grazil

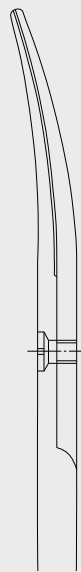
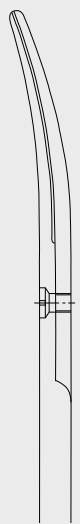

1/1

**BC271W**

180 mm  
7"

**BC275W**

200 mm  
7 7/8"

**BC277W**

230 mm  
9"

METZENBAUM

**BC271W-BC277W**

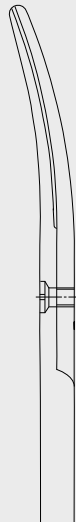

1/1

**BC261W**

145 mm  
5 3/4"

**BC263W**

180 mm  
7"

**BC265W**

200 mm  
7 7/8"

METZENBAUM

**BC261W-BC265W**

1/2

## Scissors – Scheren

DUROTIP® Wavecut Dissecting Scissors

DUROTIP® Präparierscheren mit Wellenschliff

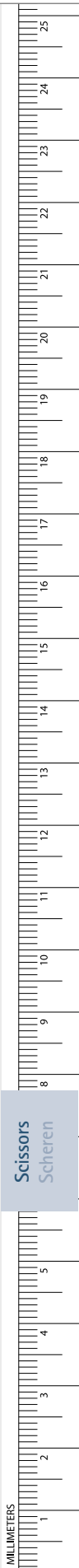
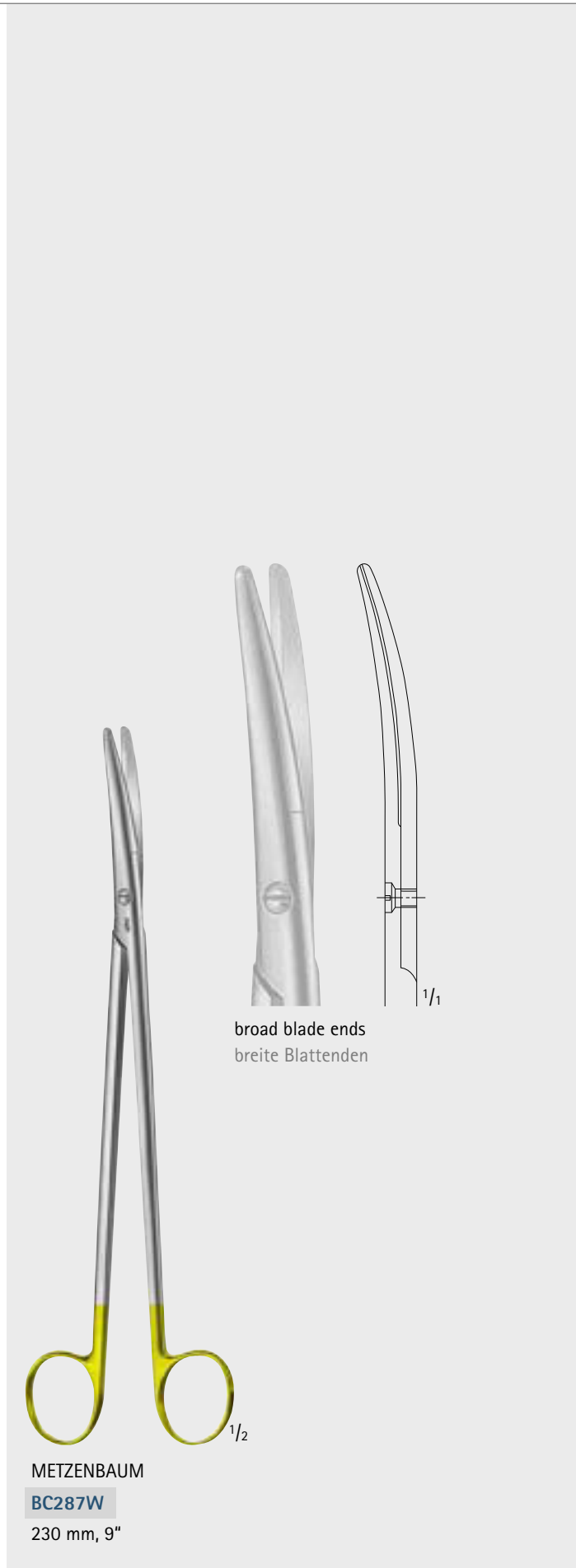
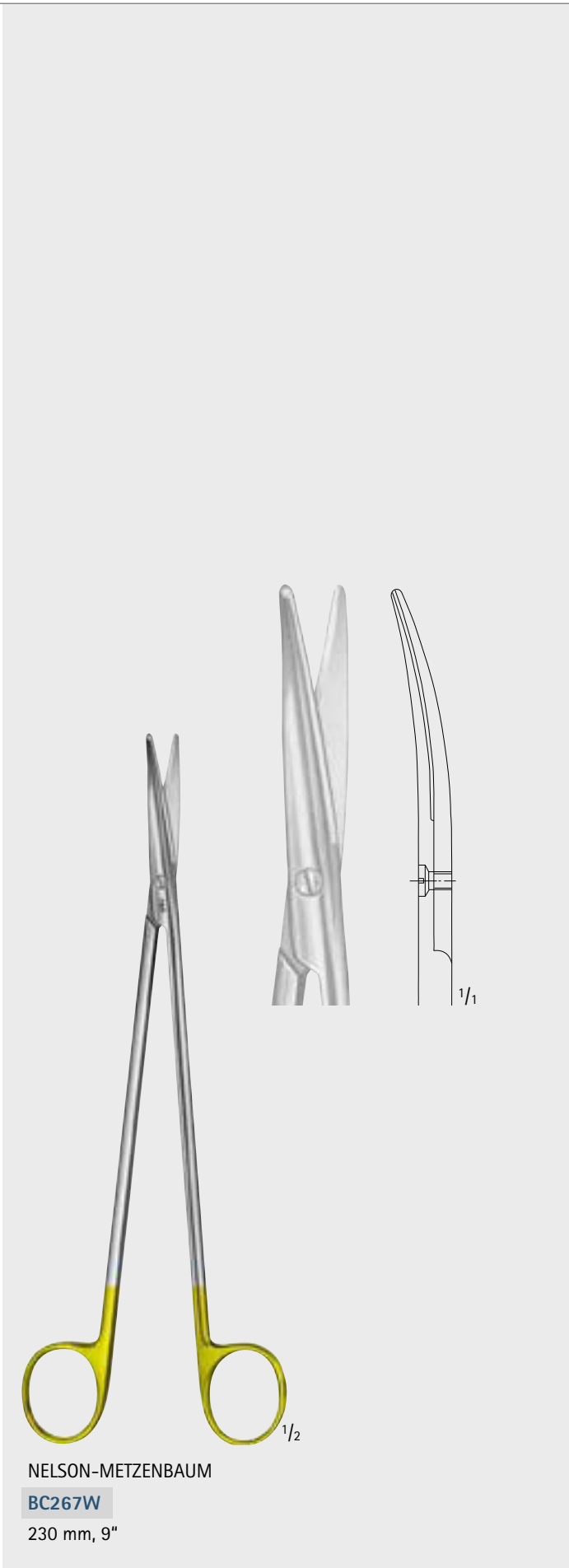

## Scissors – Scheren

### DUROTIP® Wavecut Ligature Scissors

### DUROTIP® Fadenscheren mit Wellenschliff

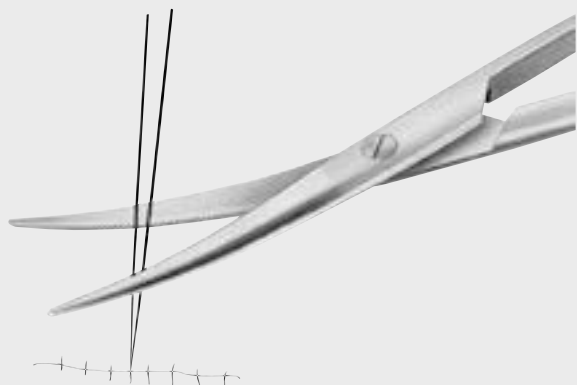

- Especially for cutting suture materials
  - Tungsten carbide inserts ensure permanent sharp cutting edge (also in the distal area of the blades)
  - Wavecut prevents suture materials from slipping out
  - DUROTIP® ligature scissors are identified by 1 goldplated ring
- Speziell zum Schneiden von Nahtmaterial
  - Hartmetalleinlagen gewähren dauerhafte Schnittschärfe (auch im distalen Bereich der Scherenblätter)
  - der Spezial-Wellenschliff verhindert das Abgleiten des Nahtmaterials
  - DUROTIP® Ligaturscheren sind gekennzeichnet mit 1 vergoldeten Ring



**BC294W**

145 mm, 5 3/4"

**BC295W**

180 mm, 7"

**BC294W-BC295W**

# Scissors – Scheren

## Supercut Scissors

## Supercut Scheren

- 1 Cutting blade with sharp Microtome edge
- 1 Cutting blade with Wavecut
  - Identification: Black marked rings, shiny instrument surface



- 1 Schneideblatt mit Mikrotomschliff
- 1 Schneideblatt mit Wellenschliff
  - Kennzeichnung: Schwarze Ringe, glänzende Oberfläche



- Microtome edge
- The extremely sharp cutting edge of the scissors blade facilitates gentle cutting of tissue with minimal use of force

- Microtome edge
- Besonders scharfer Anschlag des Scherenblattes für sanftes Durchtrennen des Gewebes bei minimalem Kraftaufwand

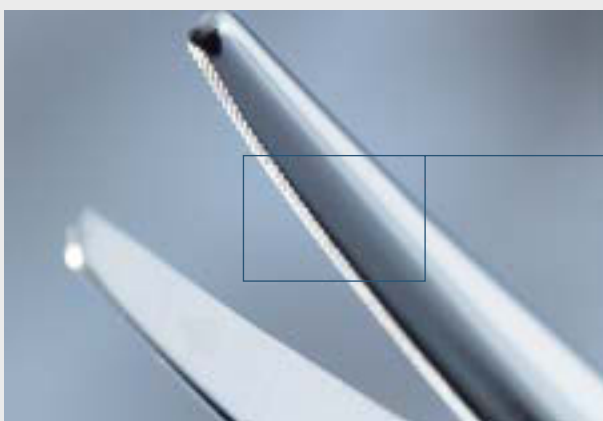

- Wavecut prevents tissue from slipping out during the cutting process

- Wellenschliff verhindert das Herausgleiten des Gewebes während des Schneidens

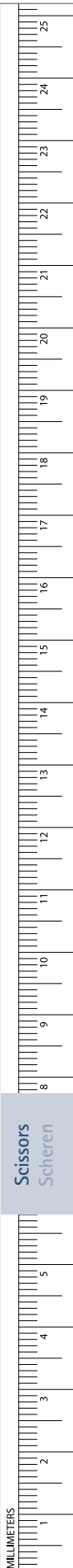

Scissors  
Scheren

# Scissors – Scheren

## Supercut Scissors

### Supercut Scheren

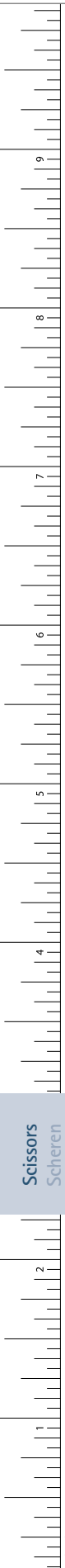

BC900R BC901R

BC900R-BC901R  
110 mm, 4 1/4"

1/2 1/1

Detailed description: This panel shows two models of Supercut Scissors. On the left is a full view of the BC900R-BC901R pair, which are 110 mm (4 1/4") long. To the right are two pairs of scissors: BC900R and BC901R. Each pair is shown with a photograph of the instrument and a corresponding line drawing. The BC900R has a straight blade, while the BC901R has a curved blade. The handles are black and have a 1/2 inch length. The line drawings include a 1/1 scale indicator.

BC903R

125 mm, 5"

1/2 1/1

Detailed description: This panel features the BC903R Supercut Scissors, which are 125 mm (5") long. It includes a full view of the instrument on the left and a photograph and line drawing of the blade on the right. The blade is curved. The handles are black and have a 1/2 inch length. The line drawing includes a 1/1 scale indicator.

BC904R BC905R

STEVENS  
BC904R-BC905R  
105 mm, 4 1/8"

1/2 1/1

Scissors  
Scheren

Detailed description: This panel shows two models of Supercut Scissors, BC904R and BC905R, which are 105 mm (4 1/8") long. On the left is a full view of the STEVENS BC904R-BC905R pair. To the right are two pairs of scissors: BC904R and BC905R. Each pair is shown with a photograph and a line drawing. The BC904R has a straight blade, and the BC905R has a curved blade. The handles are black and have a 1/2 inch length. The line drawings include a 1/1 scale indicator. A vertical label 'Scissors Scheren' is positioned on the left side of this panel.

BC906R BC907R

STEVENS  
BC906R-BC907R  
110 mm, 4 1/4"

1/2 1/1

Detailed description: This panel features two models of Supercut Scissors, BC906R and BC907R, which are 110 mm (4 1/4") long. On the left is a full view of the STEVENS BC906R-BC907R pair. To the right are two pairs of scissors: BC906R and BC907R. Each pair is shown with a photograph and a line drawing. The BC906R has a straight blade, and the BC907R has a curved blade. The handles are black and have a 1/2 inch length. The line drawings include a 1/1 scale indicator.

# Scissors – Scheren

## Supercut Scissors

### Supercut Scheren



1/2

**GOLDMAN-FOX**  
**BC909R**  
130 mm, 5 1/8"

1/1



1/2

**FOMON**  
**BC939R**  
115 mm, 4 1/2"

1/1



1/2

**JAMESON**  
**BC911R**  
130 mm, 5 1/8"

1/1



1/2

**JAMESON**  
**BC915R**  
150 mm, 6"

1/1



1/2

**JAMESON**  
**BC919R**  
180 mm, 7"

1/1

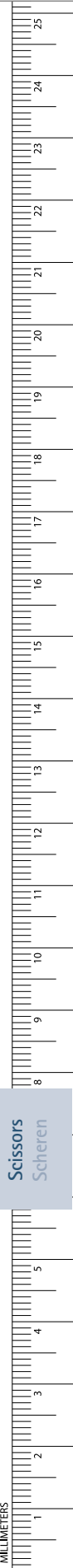

# Scissors – Scheren

## Supercut Scissors

### Supercut Scheren

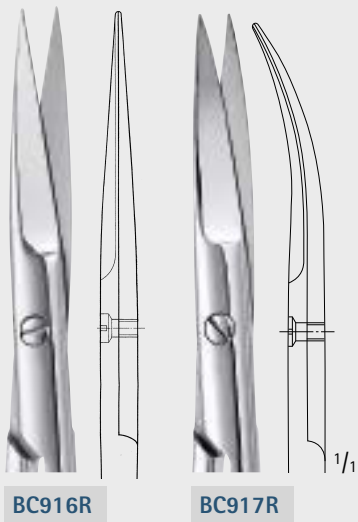
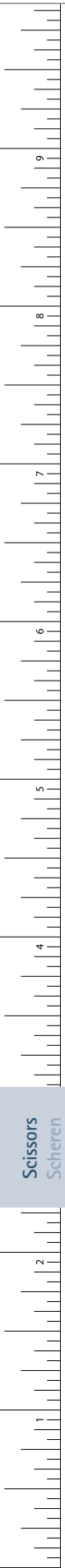

BC916R

BC917R

JOSEPH

BC916R-BC917R

150 mm, 6"

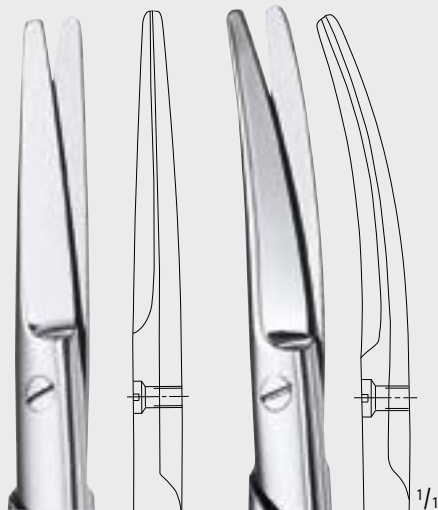

BC926R

BC927R

MAYO

BC926R-BC927R

145 mm, 5 3/4"

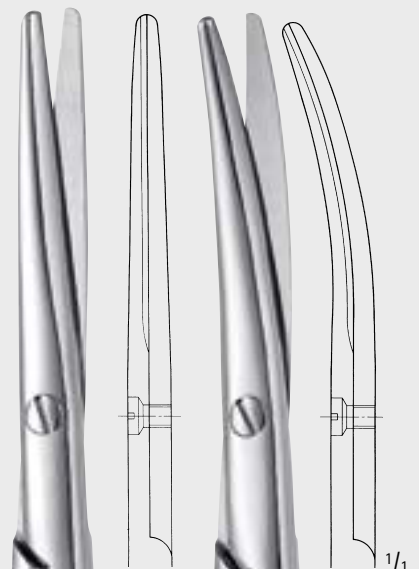

BC924R

BC925R

MAYO

BC924R-BC925R

165 mm, 6 1/2"



# Scissors – Scheren

## Supercut Scissors

### Supercut Scheren



**BABY-METZENBAUM**  
**BC930R-BC931R**  
115 mm, 4 1/2"

**BC930R** **BC931R**

1/2 1/1

Detailed description: This block shows a pair of Baby-Metzenbaum scissors. On the left is a full view of the scissors with a 1/2 scale marker. To the right are two sets of detailed views. The first set, labeled BC930R, shows the straight blades from a perspective view and a side view. The second set, labeled BC931R, shows the curved blades from a perspective view and a side view. A 1/1 scale marker is present next to the side views.



**METZENBAUM**  
**BC934R-BC935R**  
145 mm, 5 3/4"

**BC934R** **BC935R**

1/2 1/1

Detailed description: This block shows a pair of Metzenbaum scissors. On the left is a full view of the scissors with a 1/2 scale marker. To the right are two sets of detailed views. The first set, labeled BC934R, shows the straight blades from a perspective view and a side view. The second set, labeled BC935R, shows the curved blades from a perspective view and a side view. A 1/1 scale marker is present next to the side views.



**METZENBAUM**  
**BC936R-BC937R**  
180 mm, 7"

**BC936R** **BC937R**

1/2 1/1

Detailed description: This block shows a pair of Metzenbaum scissors. On the left is a full view of the scissors with a 1/2 scale marker. To the right are two sets of detailed views. The first set, labeled BC936R, shows the straight blades from a perspective view and a side view. The second set, labeled BC937R, shows the curved blades from a perspective view and a side view. A 1/1 scale marker is present next to the side views.

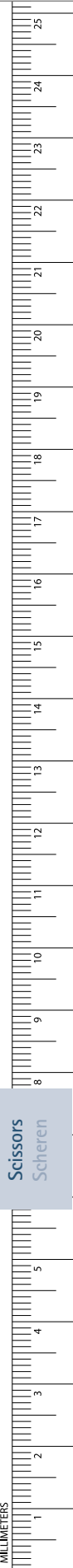

## Scissors – Scheren

### Supercut Scissors

### Supercut Scheren



GORNEY

**BC920R**

195 mm, 7 3/4"



GORNEY

**BC921R**

195 mm, 7 3/4"



KAYE

**BC933R**

195 mm, 7 3/4"

Scissors  
Scheren

INCHES

# Scissors – Scheren

## Delicate Scissors

### Feine Scheren

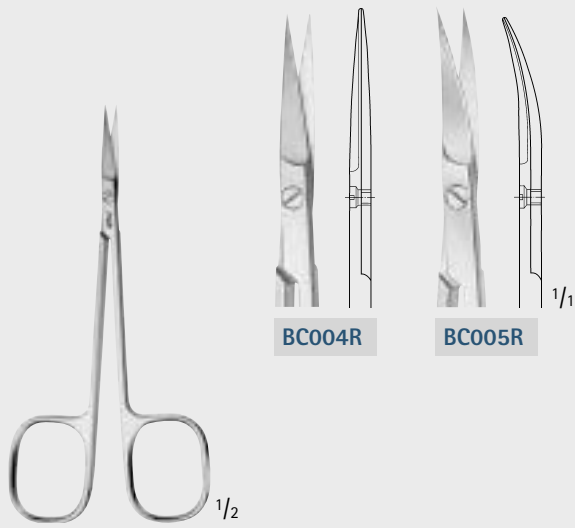

BC004R

BC005R

BC004R-BC005R

115 mm, 4 1/2"

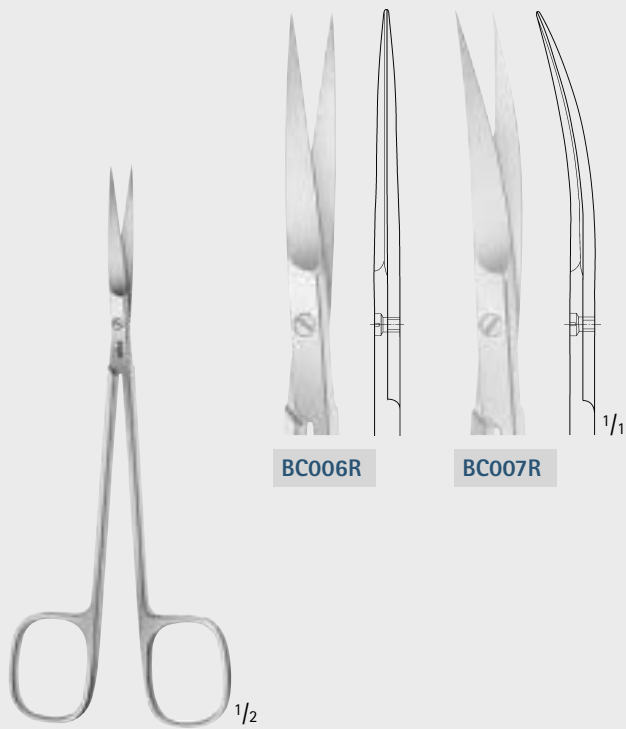

BC006R

BC007R

JOSEPH

BC006R-BC007R

150 mm, 6"

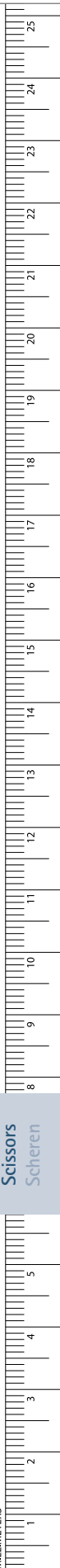

# Scissors – Scheren

## Delicate Scissors

### Feine Scheren

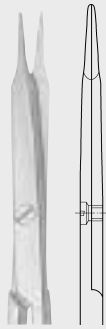
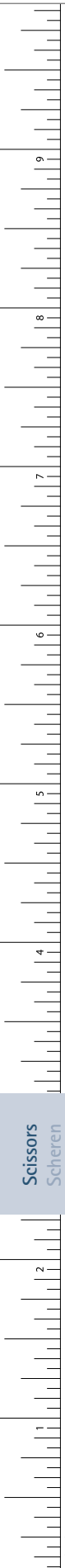

**BC008R**

sharp  
spitz



**BC009R**

sharp  
spitz

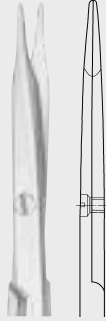

**BC010R**

blunt  
stumpf

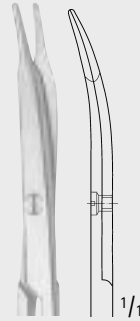

**BC011R**

blunt  
stumpf

STEVENS

**BC008R-BC011R**

Dissecting scissors

Präparierscheren

115 mm, 4 1/2"

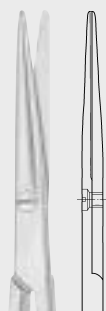

**BC020R**

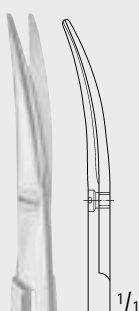

**BC021R**

**BC020R-BC021R**

Dissecting- and strabismus scissors

Präparier- und Strabismusscheren

115 mm, 4 1/2"

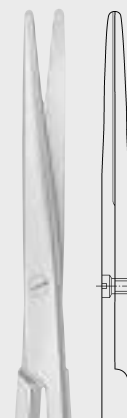

**BC022R**

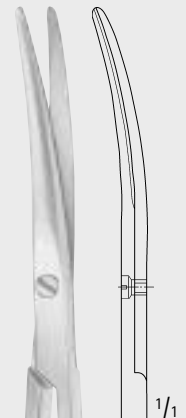

**BC023R**

METZENBAUM

**BC022R-BC023R**

Dissecting scissors

Präparierscheren

145 mm, 5 3/4"

# Scissors – Scheren

## Delicate Scissors

### Feine Scheren



REYNOLDS-JAMESON  
**BC015R**  
 Vascular scissors  
 Gefäßschere  
 140 mm, 5 1/2"



**BC017R**  
 Nerve dissecting scissors  
 Nerv-Präparierschere  
 140 mm, 5 1/2"

blades outside semi-sharp  
 Außenkanten der Blätter halbscharf



**RAGNELL**  
**BC026R-BC029R**  
 special flat tips for dissecting and undermining the skin  
 besonders flache Spitzen zum Präparieren und Unterminieren der Haut

**BC026R**  
 135 mm  
 5 1/4"

**BC027R**  
 135 mm  
 5 1/4"

**BC029R**  
 150 mm  
 6"

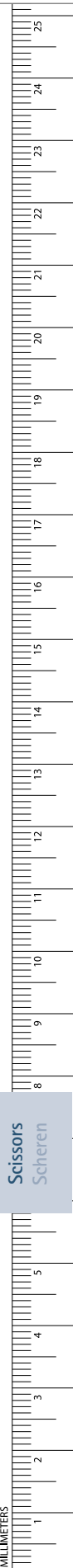

Scissors  
Scheren

# Scissors – Scheren

## Delicate Scissors

### Feine Scheren

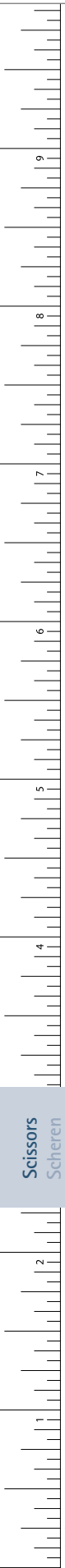

**BC100R-BC101R**  
90 mm, 3 1/2"

**BC100R** **BC101R**

1/2 1/1

**BC056R-BC057R**  
95 mm, 3 3/4"

**BC056R** **BC057R**

1/2 1/1

**BC060R-BC061R**  
105 mm, 4 1/8"

**BC060R** **BC061R**

1/2 1/1

**BC064R-BC065R**  
120 mm, 4 3/4"

**BC064R** **BC065R**

1/2 1/1

Scissors  
Scheren

# Scissors – Scheren

## Delicate Scissors

### Feine Scheren

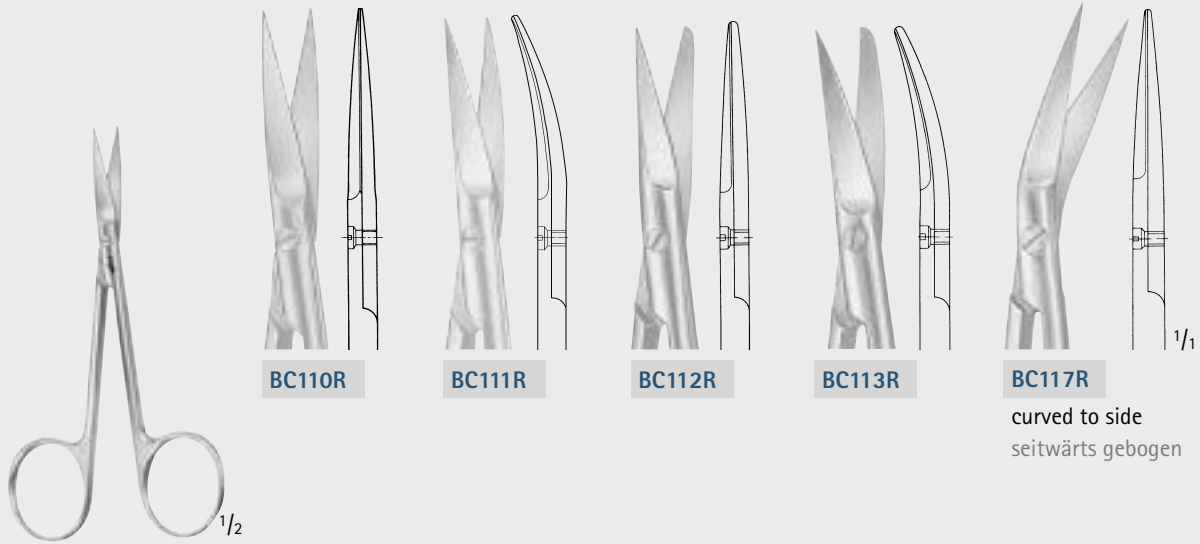

**BC110R-BC117R**

110 mm, 4 1/4"

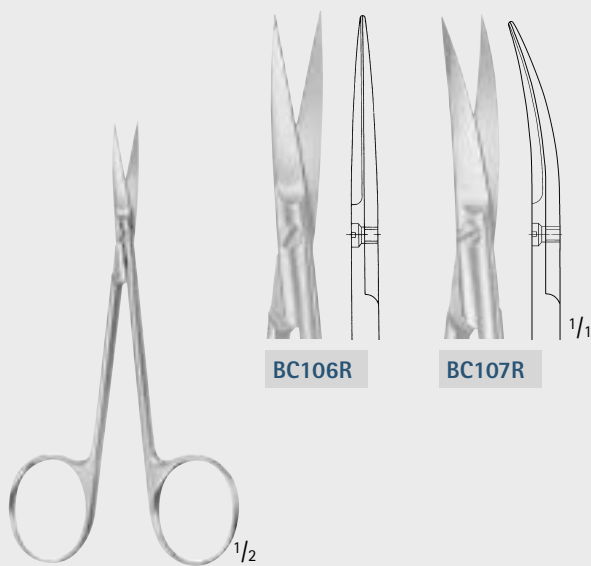

**BC106R-BC107R**

115 mm, 4 1/2"

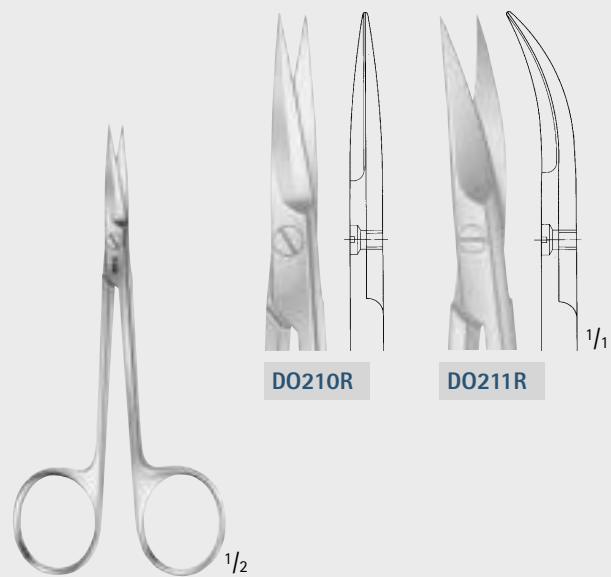

**DO210R-DO211R**

120 mm, 4 3/4"

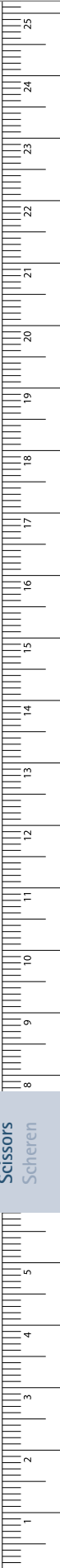

# Scissors - Scheren

## Delicate Scissors

### Feine Scheren



BC130R

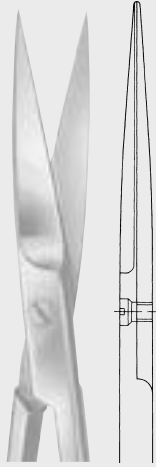

BC131R

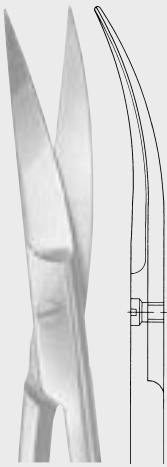

BC135R

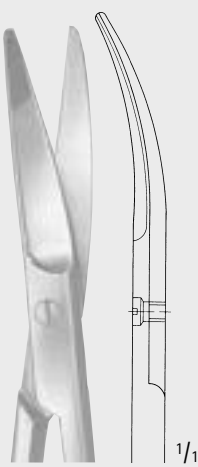

BC130R-BC135R

120 mm, 4 3/4"



BC140R

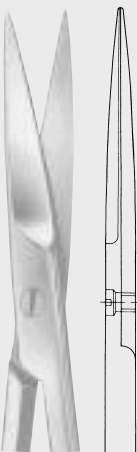

BC141R

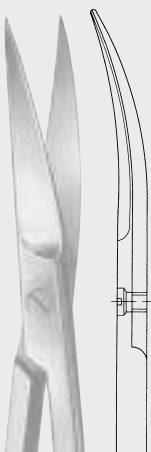

BC144R

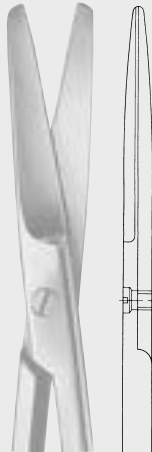

BC145R

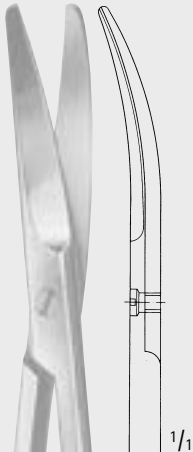

BC140R-BC145R

130 mm, 5 1/8"



# Scissors – Scheren

## Delicate Scissors

### Feine Scheren

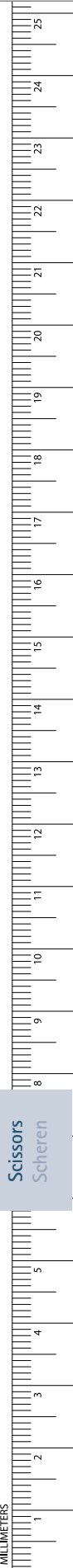
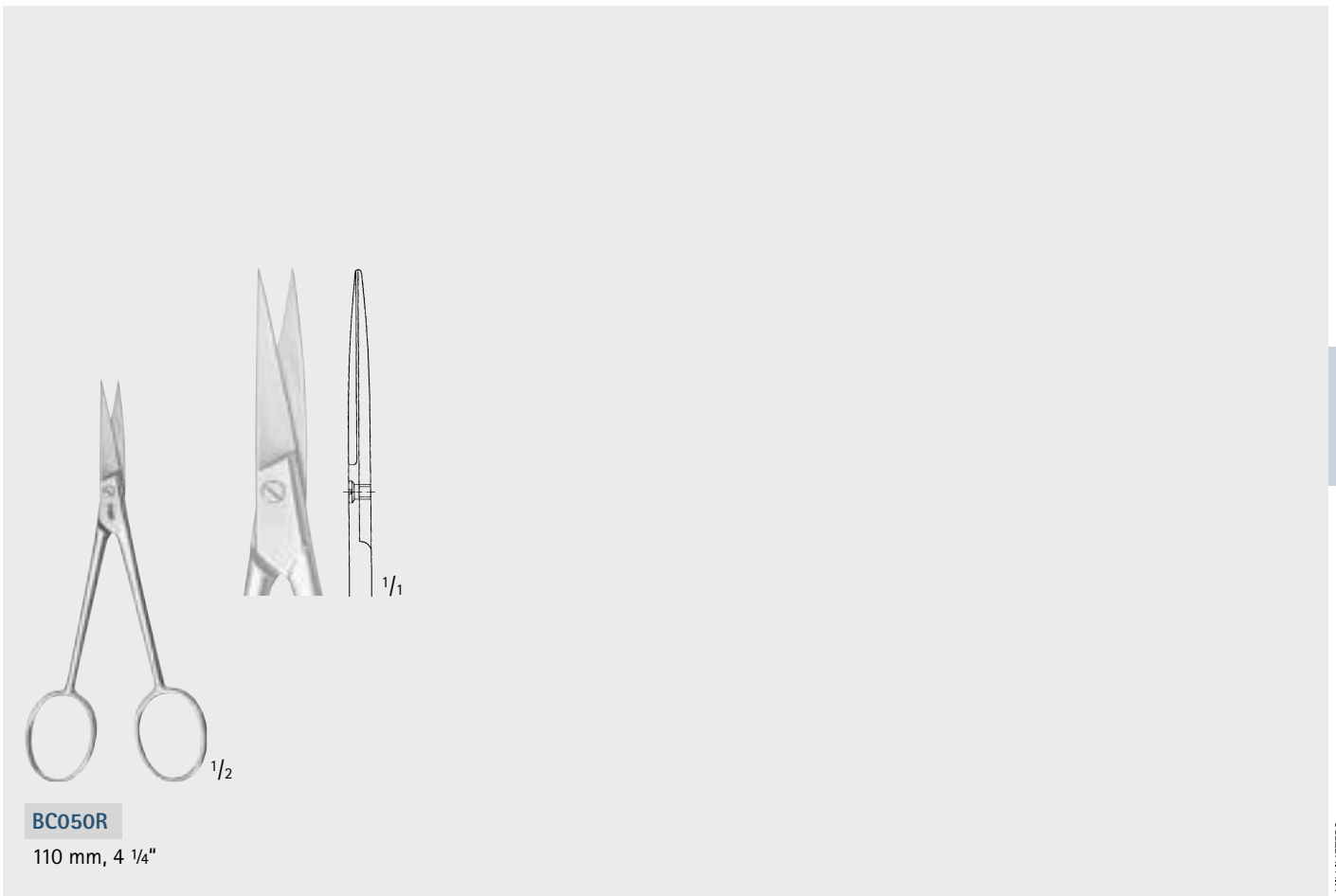
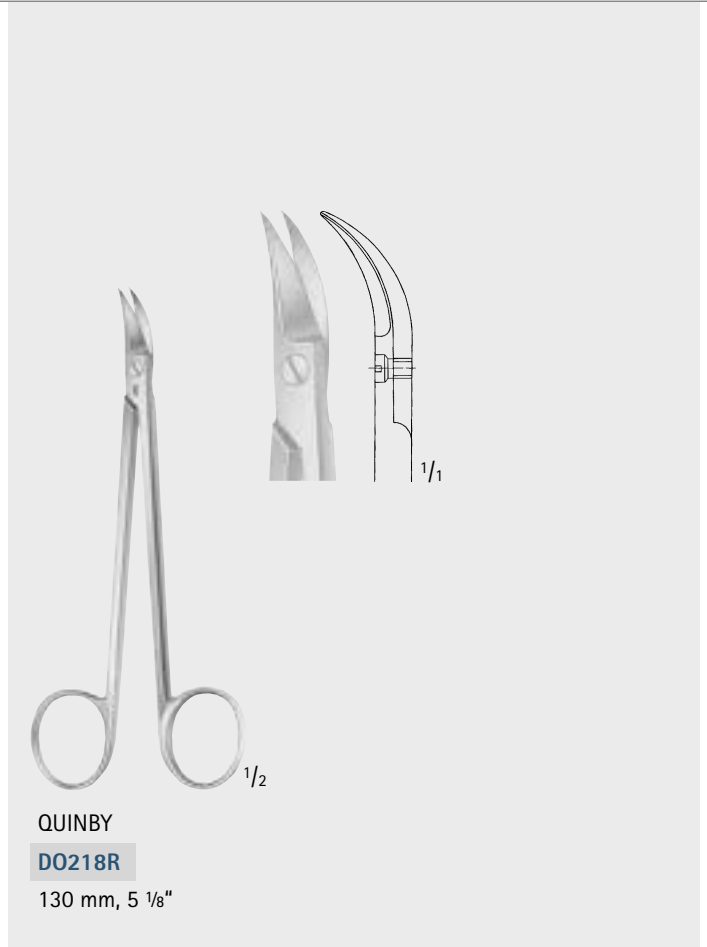
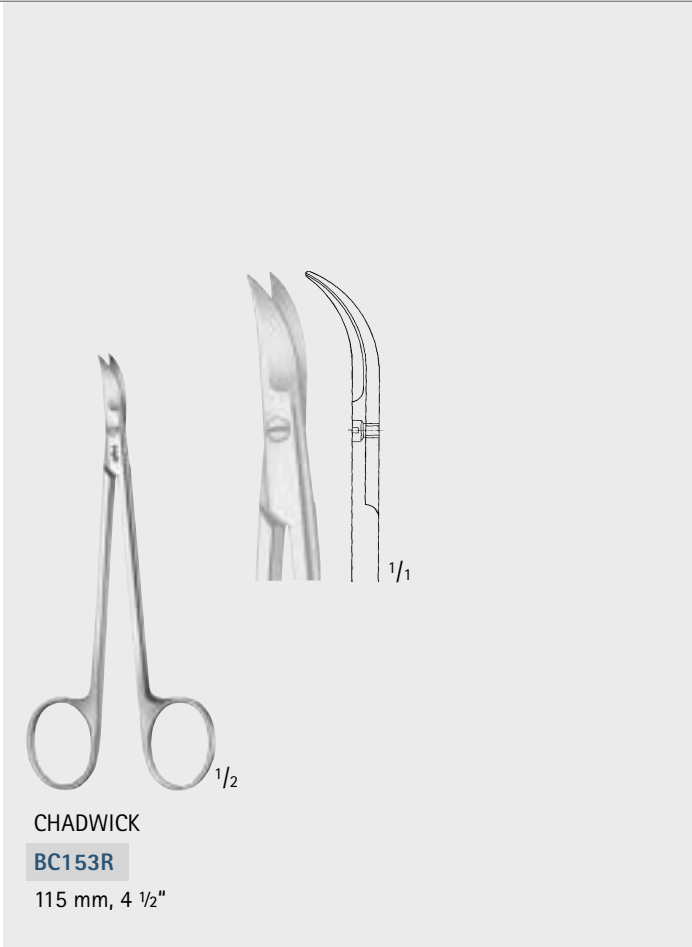

# Scissors – Scheren

## Delicate Scissors

### Feine Scheren



curved to side  
seitwärts gebogen

PERWITZSCHKY

**OM489R**

Salival scissors  
Speichelgangschere  
100 mm, 4"

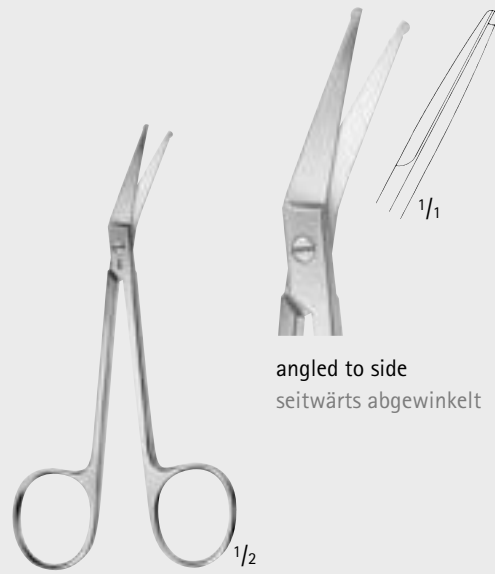

angled to side  
seitwärts abgewinkelt

**BC033R**

115 mm, 4 1/2"

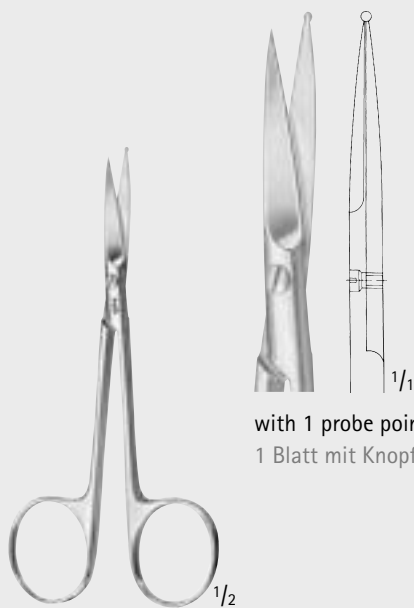

with 1 probe pointed blade  
1 Blatt mit Knopf

**BC030R**

120 mm, 4 3/4"

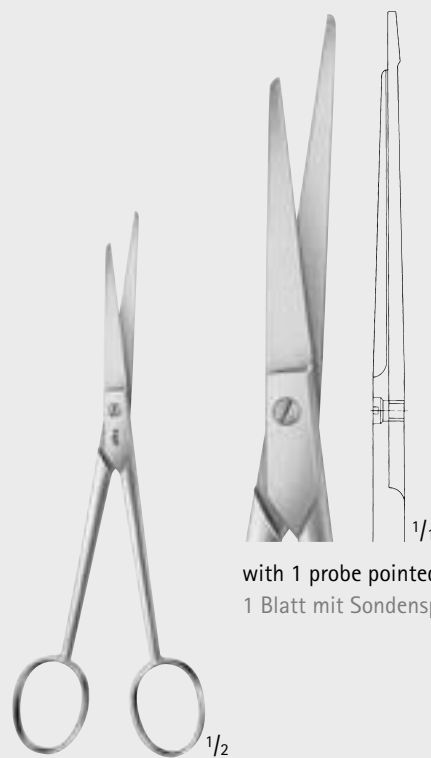

with 1 probe pointed blade  
1 Blatt mit Sondenspitze

**BC034R**

145 mm, 5 3/4"

Scissors  
Scheren

# Scissors – Scheren

## Delicate Scissors

### Feine Scheren



1 blade serrated  
1 Schneide gezahnt

1/2

**LA GRANGE**  
**BC154R**  
110 mm, 4 1/4"



1 blade fine serrated  
1 Schneide fein gezahnt

1/2

**DO251R**  
130 mm, 5 1/8"



angled to side,  
1 blade serrated  
seitwärts abgewinkelt,  
1 Schneide gezahnt

1/2

**LOCKLIN**  
**DO219R**  
155 mm, 6 1/8"

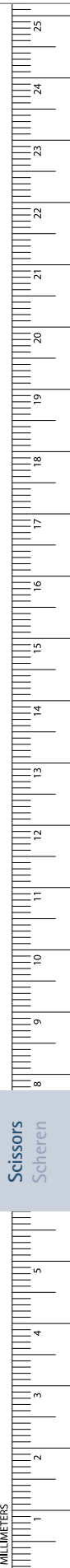

# Scissors – Scheren

## Delicate Scissors

### Feine Scheren

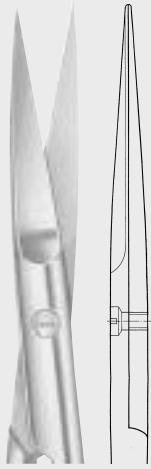
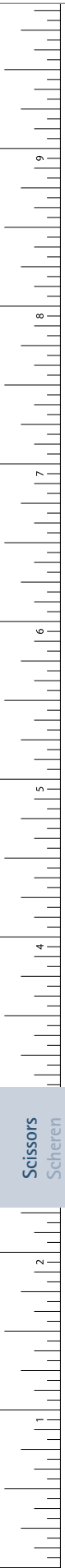

BC156R

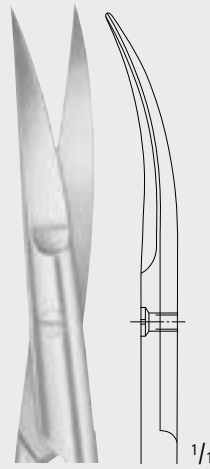

BC157R

JOSEPH

BC156R-BC157R

150 mm, 6"

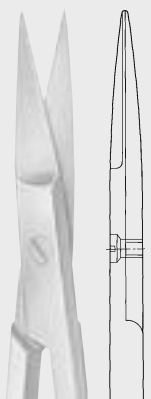

BC160R

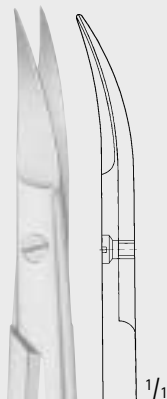

BC161R

KELLY

BC160R-BC161R

175 mm, 6 7/8"



1 blade serrated  
1 Schneide gezahnt

MORSE

BC196R

175 mm, 6 7/8"

# Scissors – Scheren

## Surgical Scissors

### Chirurgische Scheren

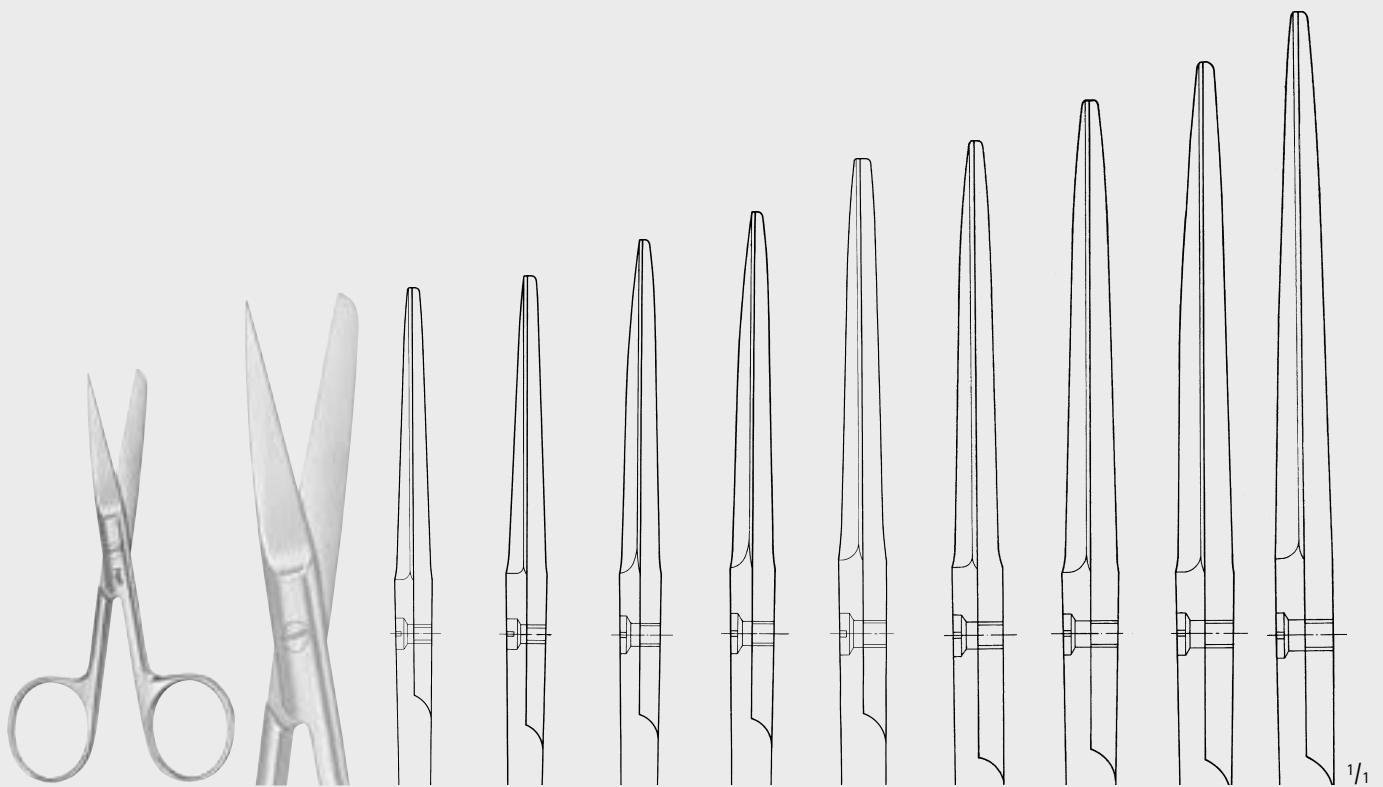

**BC320R-BC330R**  
Standard patterns  
Standard-Modelle

BC320R	BC321R	BC323R	BC324R	BC325R	BC326R	BC327R	BC328R	BC330R
105 mm	115 mm	130 mm	145 mm	150 mm	165 mm	175 mm	185 mm	200 mm
4 1/8"	4 1/2"	5 1/8"	5 3/4"	6"	6 1/2"	6 7/8"	7 1/4"	7 7/8"

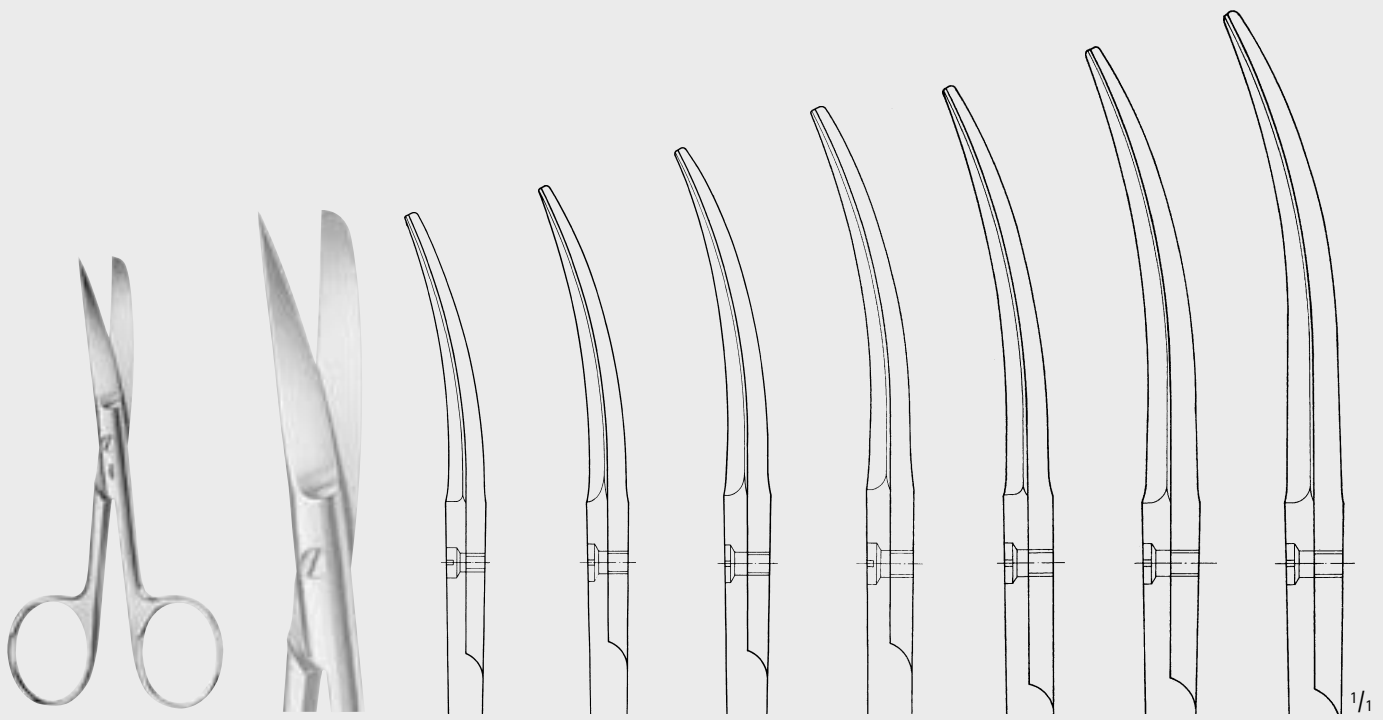

**BC421R-BC428R**  
Standard patterns  
Standard-Modelle

BC421R	BC423R	BC424R	BC425R	BC426R	BC427R	BC428R
115 mm	130 mm	145 mm	150 mm	165 mm	175 mm	185 mm
4 1/2"	5 1/8"	5 3/4"	6"	6 1/2"	6 7/8"	7 1/4"

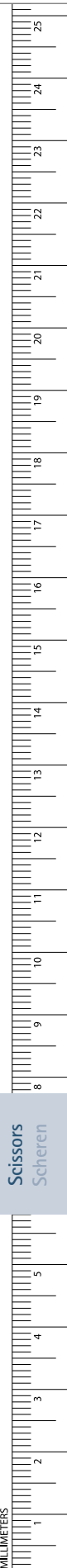

# Scissors - Scheren

## Surgical Scissors

### Chirurgische Scheren



**BC303R-BC304R**  
slender patterns  
schlanke Modelle

<b>BC303R</b>	<b>BC304R</b>
130 mm	145 mm
5 1/8"	5 3/4"

**BC496R**  
Scissors for wound edges  
Wundrandschere  
130 mm, 5 1/8"

1 blade serrated  
1 Blatt gezahnt

**BC403R-BC404R**  
slender patterns  
schlanke Modelle

<b>BC403R</b>	<b>BC404R</b>
130 mm	145 mm
5 1/8"	5 3/4"

**BC497R**  
130 mm, 5 1/8"

1 blade serrated  
1 Blatt gezahnt

# Scissors – Scheren

## Surgical Scissors

### Chirurgische Scheren

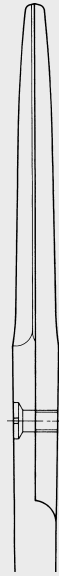

COOPER

**BC313R-BC317R**

Standard patterns  
Standard-Modelle

**BC313R**

130 mm  
5 1/8"

**BC314R**

145 mm  
5 3/4"

**BC315R**

150 mm  
6"

**BC316R**

165 mm  
6 1/2"

**BC317R**

175 mm  
6 7/8"

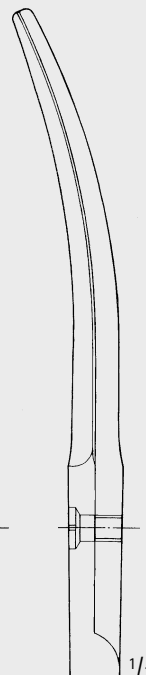
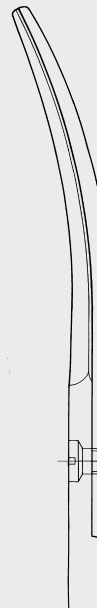

COOPER

**BC411R-BC417R**

Standard patterns  
Standard-Modelle

**BC411R**

115 mm  
4 1/2"

**BC413R**

130 mm  
5 1/8"

**BC414R**

145 mm  
5 3/4"

**BC415R**

150 mm  
6"

**BC416R**

165 mm  
6 1/2"

**BC417R**

175 mm  
6 7/8"

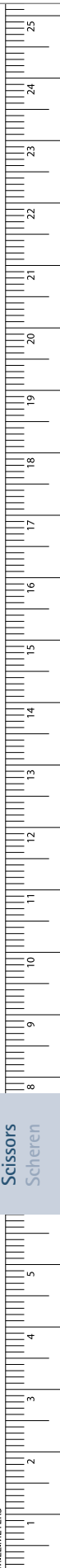

Scissors  
Scheren

# Scissors - Scheren

## Surgical Scissors

### Chirurgische Scheren

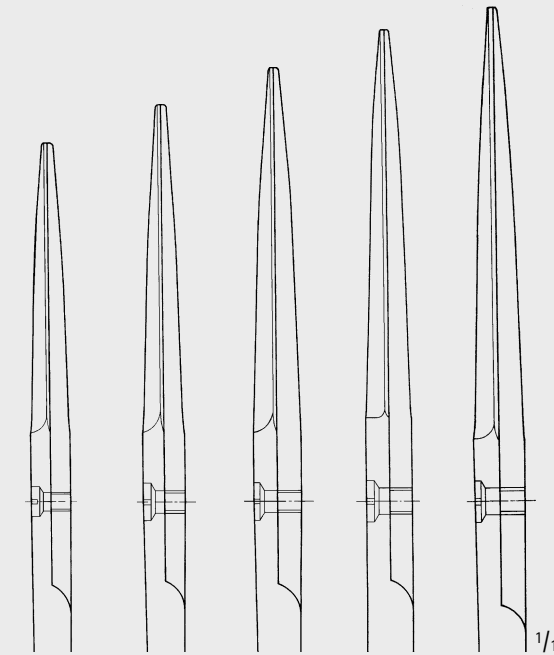

**BC341R-BC346R**

Standard patterns  
Standard-Modelle

BC341R	BC343R	BC344R	BC345R	BC346R
115 mm	130 mm	145 mm	150 mm	165 mm
4 1/2"	5 1/8"	5 3/4"	6"	6 1/2"

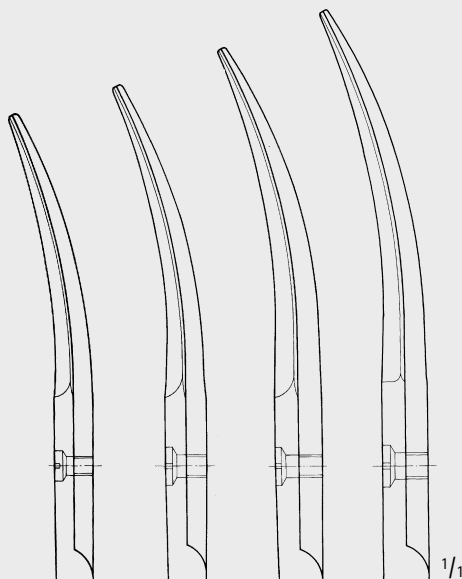

**BC441R-BC445R**

Standard patterns  
Standard-Modelle

BC441R	BC443R	BC444R	BC445R
115 mm	130 mm	145 mm	150 mm
4 1/2"	5 1/8"	5 3/4"	6"



# Scissors – Scheren

## Surgical Scissors

### Chirurgische Scheren



DEAVER

**BC374R-BC464R**

145 mm, 5 3/4"

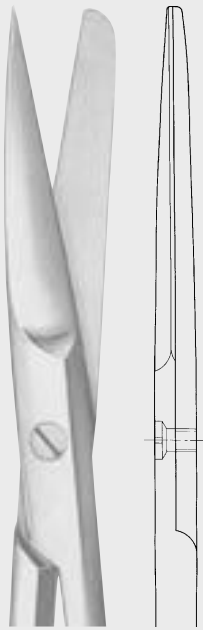

**BC374R**

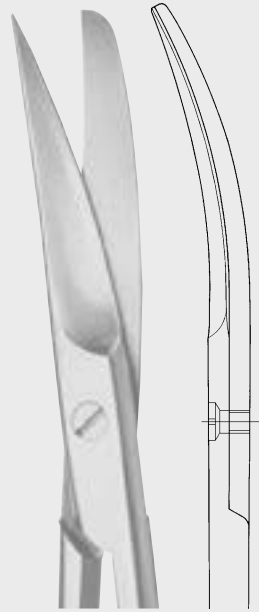

**BC474R**

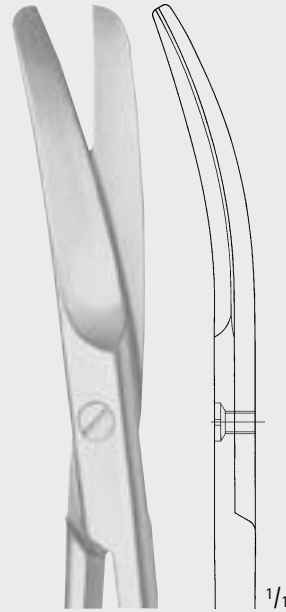

**BC464R**



**BC503R-BC506R**

Incision scissors  
Inzisions-Scheren

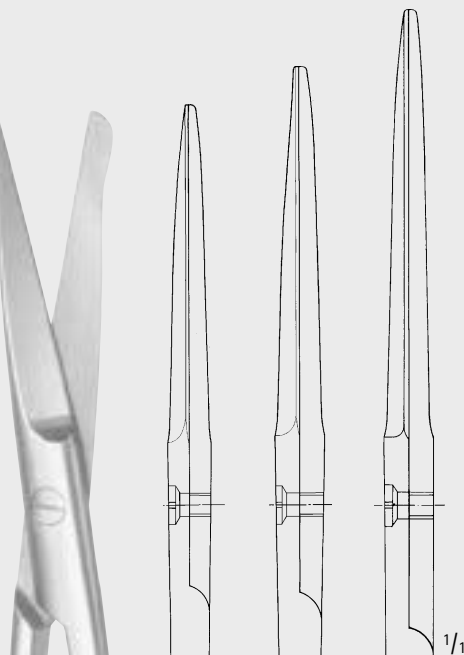

**BC503R**

130 mm  
5 1/8"

**BC504R**

145 mm  
5 3/4"

**BC506R**

165 mm  
6 1/2"

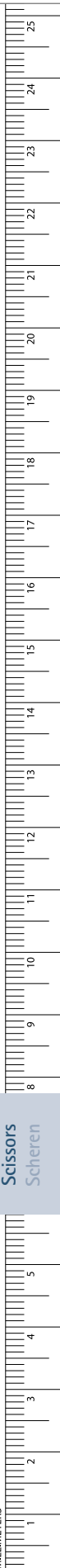

Scissors  
Scheren

MILLIMETERS

## Scissors – Scheren

Dissecting Scissors, Delicate Patterns

Präparierscheren, feine Modelle



**GRAEFE**  
**OC415R**  
100 mm, 4"

**BC058R**  
105 mm, 4 1/8"

**BC164R**      **BC165R**

**BC164R-BC165R**  
115 mm, 4 1/2"

tips with eye for suture  
mit Fadenbohrung in der Spitze

**LITTLER**  
**BC163R**  
115 mm, 4 1/2"

**COTTLE**  
**OK374R**  
115 mm, 4 1/2"

**KILNER**  
**BC162R**  
115 mm, 4 1/2"

## Scissors – Scheren

### Dissecting Scissors, Delicate Patterns

### Präparierscheren, feine Modelle



**OK365R**  
sharp  
spitz

**OK367R**  
blunt  
stumpf

**COTTLE-MASING**  
**OK365R-OK367R**  
Scissors for plastic surgery  
Scheren für die plastische Chirurgie  
105 mm, 4 1/8"

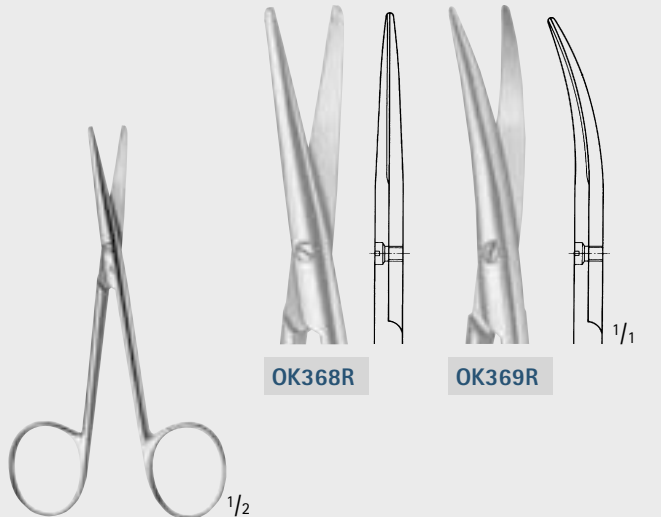

**OK368R**

**OK369R**

**COTTLE-KNAPP**  
**OK368R-OK369R**  
Scissors for plastic surgery  
Scheren für die plastische Chirurgie  
105 mm, 4 1/8"



**OK372R**  
135 mm  
5 1/4"

**OK373R**  
115 mm  
4 1/2"

**FOMON**  
**OK372R-OK373R**  
Lower lateral scissors  
Nasenflügelscheren



**LANDOLT**  
**OC430R**  
Enucleation scissors  
Enukleationsschere  
125 mm, 5"

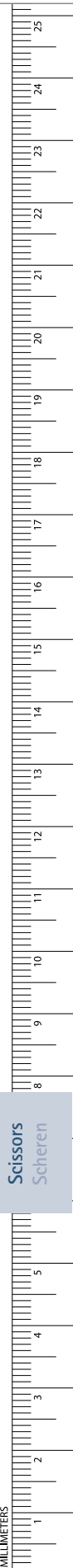

## Scissors – Scheren

Dissecting Scissors, Delicate Patterns

Präparierscheren, feine Modelle

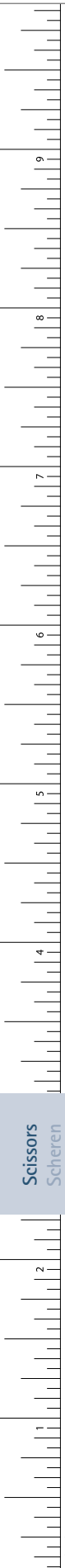

**BC186R**      **BC187R**

**STEVENS**  
**BC186R-BC187R**  
100 mm, 4"

**grazil**

**STEVENS**  
**OK366R**  
110 mm, 4 1/4"

**BC170R**      **BC171R**      **BC172R**      **BC173R**      **BC194R**      **BC195R**

sharp      sharp      blunt      blunt      blunt      blunt  
spitz      spitz      stumpf      stumpf      stumpf      stumpf  
110 mm      110 mm      110 mm      110 mm      125 mm      125 mm  
4 1/4"      4 1/4"      4 1/4"      4 1/4"      5"      5"

**STEVENS**  
**BC170R-BC195R**

## Scissors – Scheren

### Dissecting Scissors, Delicate Patterns

### Präparierscheren, feine Modelle

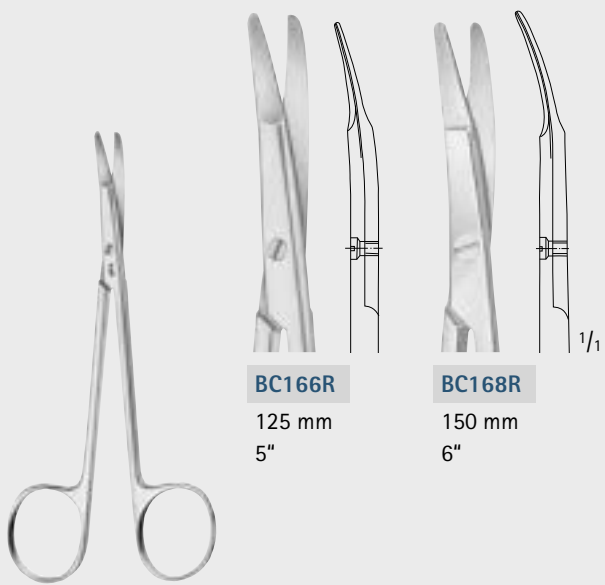

**BC166R**  
125 mm  
5"

**BC168R**  
150 mm  
6"

**KILNER**  
**BC166R-BC168R**  
special flat points for dissecting and undermining the skin  
besonders flache Spitzen zum Präparieren und Unterminieren der Haut

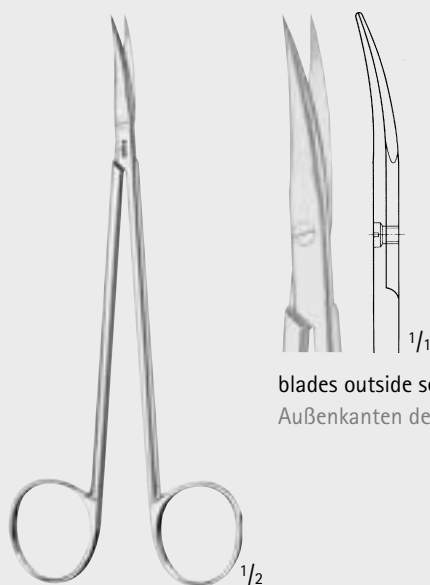

blades outside semi-sharp  
Außenkanten der Blätter halbscharf

**BC628R**  
Nerve dissecting scissors  
Nerv-Präparierschere  
150 mm, 6"

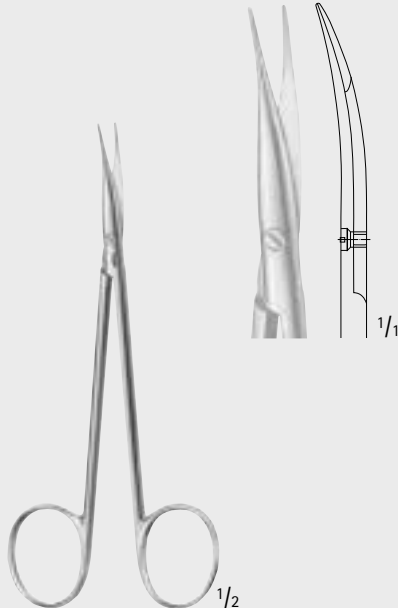

**BC175R**  
130 mm, 5 1/8"

**JAMESON-WERBER**

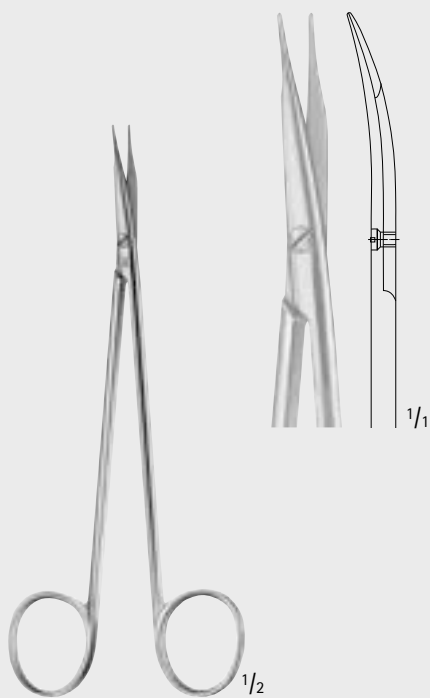

**BC177R**  
150 mm, 6"

**JAMESON**

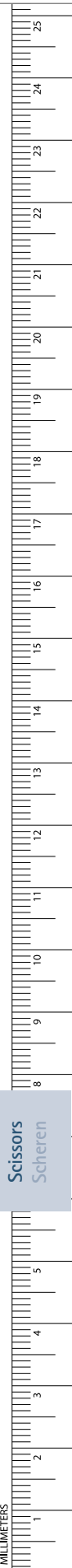

## Scissors – Scheren

Dissecting Scissors, Delicate Patterns

Präparierscheren, feine Modelle

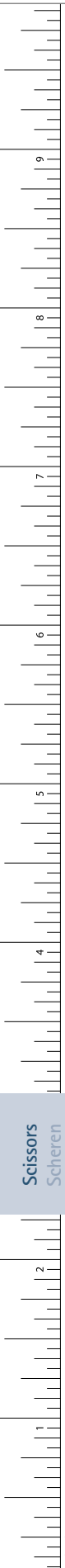

**REYNOLDS**  
**BC180R-BC181R**

<b>BC180R</b>	<b>BC181R</b>
145 mm	175 mm
5 3/4"	6 7/8"

**POTTS**  
**BC178R**

175 mm, 6 7/8"

**DE BAKEY**  
**BC629R**

175 mm, 6 7/8"

**TÖNNIS-ADSON**  
**BC630R-BC631R**

<b>BC630R</b>	<b>BC631R</b>
very delicate sehr fein	delicate fein

175 mm, 6 7/8"

Scissors  
Scheren

Scissors – Scheren  
 Dissecting Scissors  
 Präparierscheren



TÖNNIS

BC633R-BC635R

180 mm, 7"

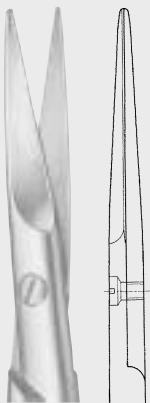

**BC633R**  
 very delicate  
 sehr fein

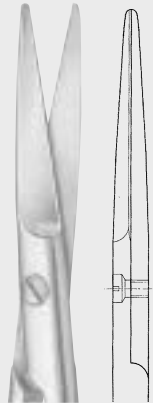

**BC634R**  
 delicate  
 fein

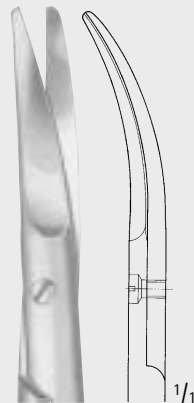

**BC635R**  
 delicate  
 fein



GORNEY

BC184R-BC189R

for plastic surgery  
 Blades: outside semi-sharp, inside fine serrated  
 für plastische Chirurgie  
 Schneiden: außen halbscharf, innen fein gezahnt

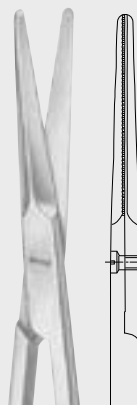

**BC184R**  
 125 mm  
 5"

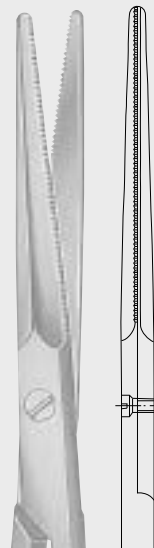

**BC188R**  
 195 mm  
 7 3/4"

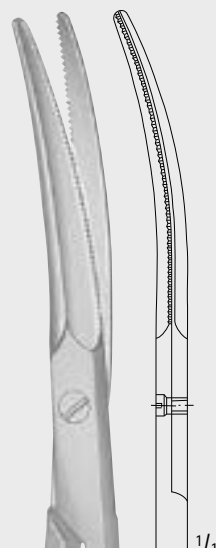

**BC189R**  
 195 mm  
 7 3/4"

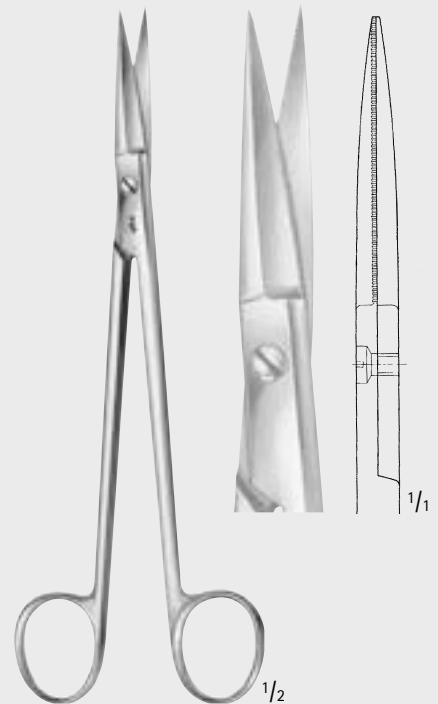

**BC672R**

Cartilage scissors,  
 blades cutting on both sides  
 Knorpelschere,  
 Blätter außen und innen schneidend  
 185 mm, 7 1/4"

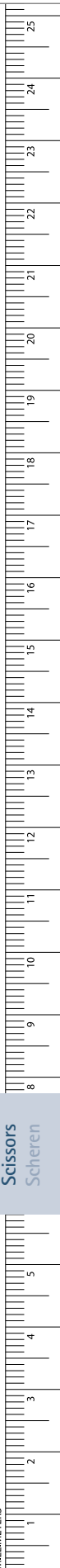

Scissors  
 Scheren

# Scissors - Scheren

## Dissecting Scissors

### Präparierscheren



MAYO

BC544R-BC557R



BC544R

140 mm  
5 1/2"



BC545R

155 mm  
6 1/8"



BC547R

170 mm  
6 3/4"



BC554R

140 mm  
5 1/2"



BC555R

155 mm  
6 1/8"



BC557R

170 mm  
6 3/4"

1/1



MAYO-STILLE

BC570R-BC575R



BC570R

140 mm  
5 1/2"



BC572R

170 mm  
6 3/4"



BC573R

140 mm  
5 1/2"



BC575R

170 mm  
6 3/4"

1/1

Scissors  
Scheren

INCHES



**Scissors – Scheren**  
**Dissecting Scissors**  
 Präparierscheren



MAYO-STILLE

**BC576R-BC579R**

with chamfered blades  
 mit abgeschrägten Schneiden

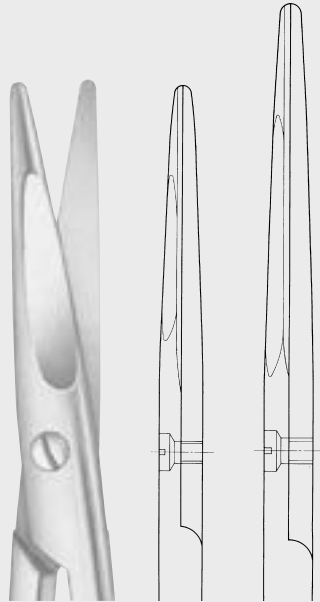

**BC576R**

**BC578R**

140 mm

165 mm

5 1/2"

6 1/2"

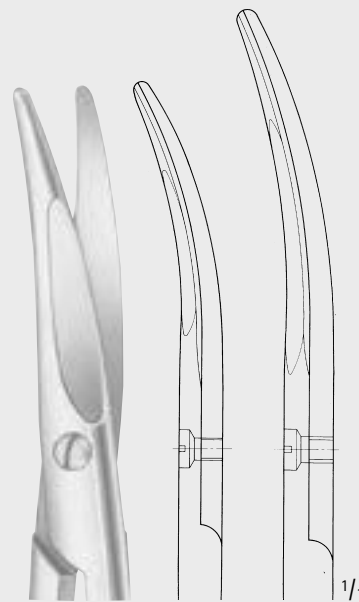

**BC577R**

**BC579R**

140 mm

165 mm

5 1/2"

6 1/2"

1/1



MAYO

**BC562R-BC565R**

with chamfered blades  
 mit abgeschrägten Schneiden

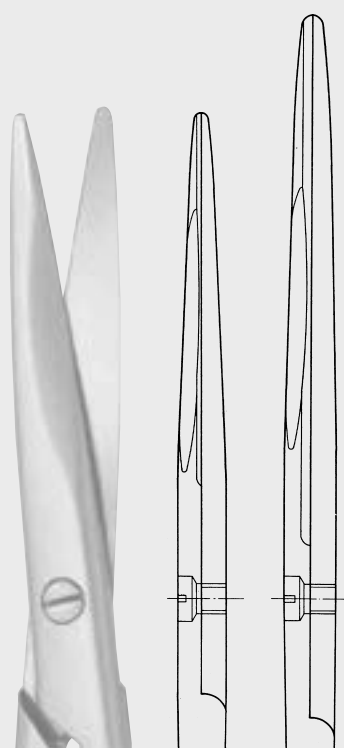

**BC562R**

**BC564R**

190 mm

215 mm

7 1/2"

8 1/2"

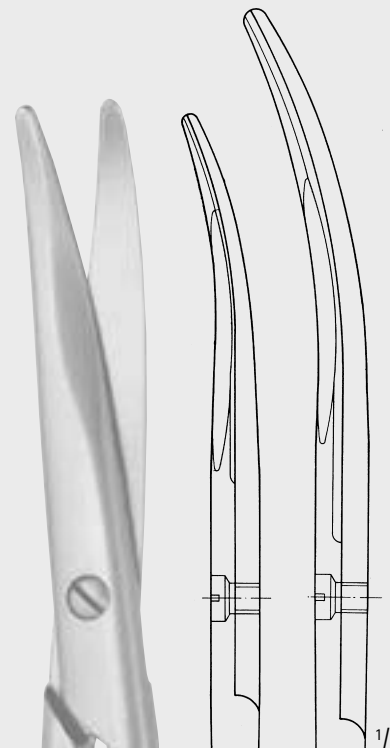

**BC563R**

**BC565R**

190 mm

215 mm

7 1/2"

8 1/2"

1/1

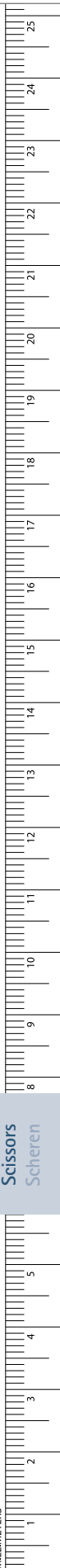

Scissors  
 Scheren

MILLIMETERS

## Scissors - Scheren

### Dissecting Scissors

#### Präparierscheren

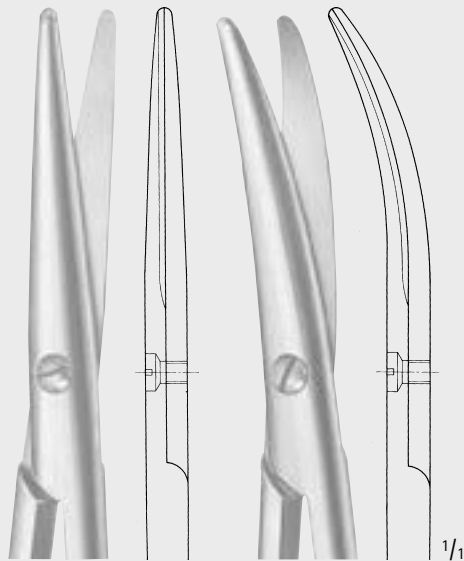
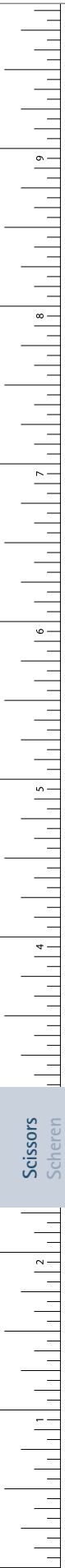

BC580R

BC581R

STILLE

BC580R-BC581R

150 mm, 6"

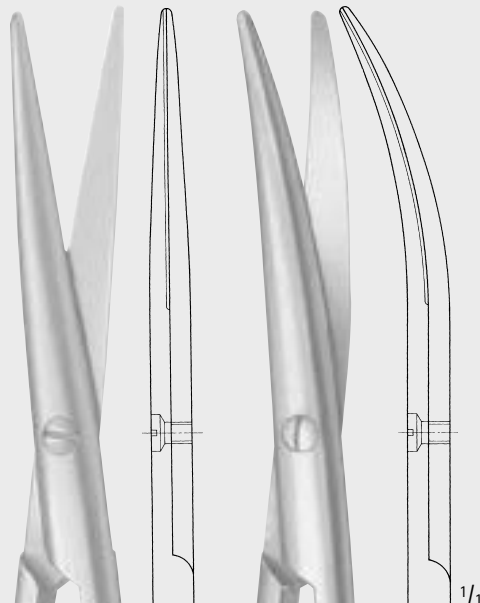

BC590R

BC591R

LEXER

BC590R-BC591R

narrow  
schmal  
165 mm, 6 1/2"

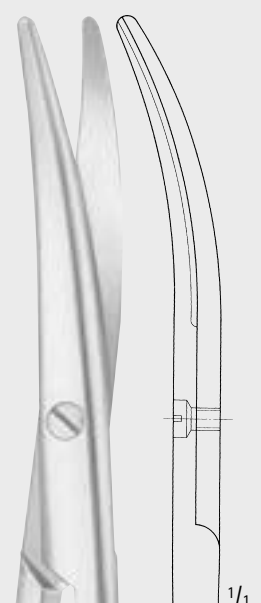
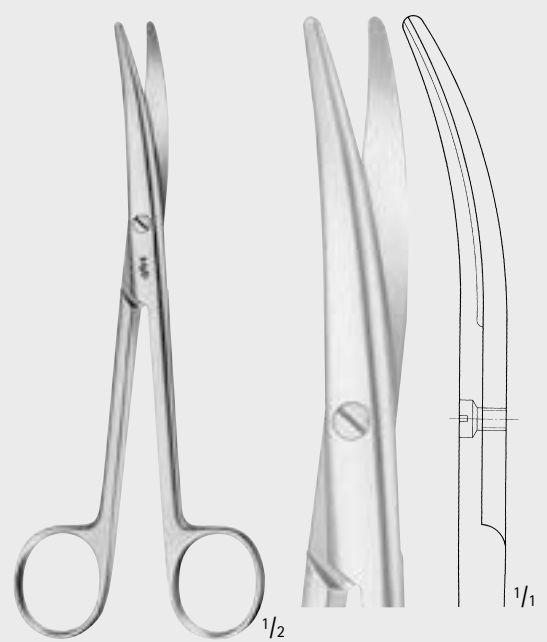

MAYO-LEXER

BC592R

Standard pattern  
Standard-Modell  
165 mm, 6 1/2"

Scissors – Scheren  
 Dissecting Scissors  
 Präparierscheren

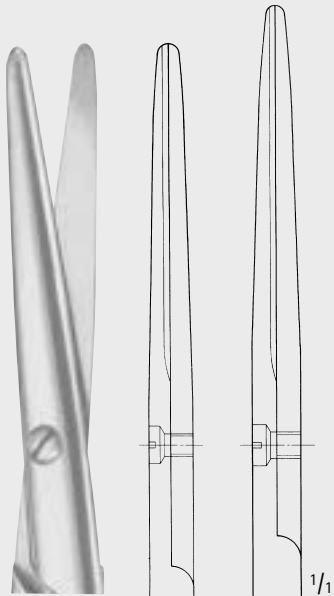

<b>BC584R</b>	<b>BC585R</b>
165 mm	200 mm
6 1/2"	7 7/8"

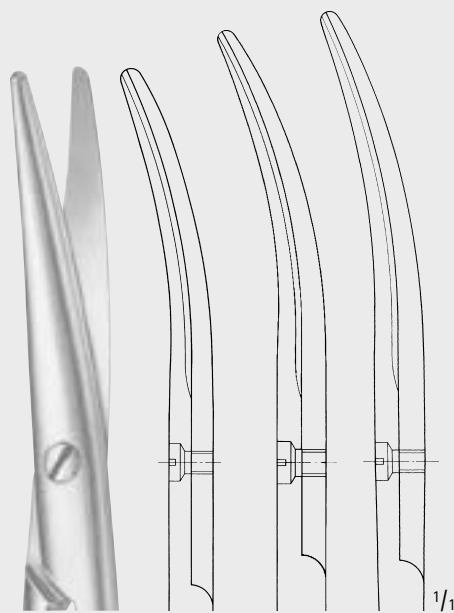

<b>BC587R</b>	<b>BC588R</b>	<b>BC589R</b>
165 mm	200 mm	210 mm
6 1/2"	7 7/8"	8 1/4"



MAYO

**BC584R-BC589R**

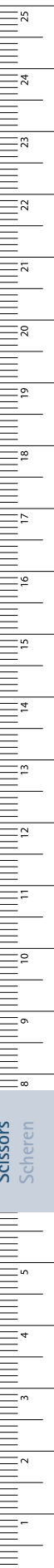

MILLIMETERS

# Scissors - Scheren

## Dissecting Scissors

### Präparierscheren

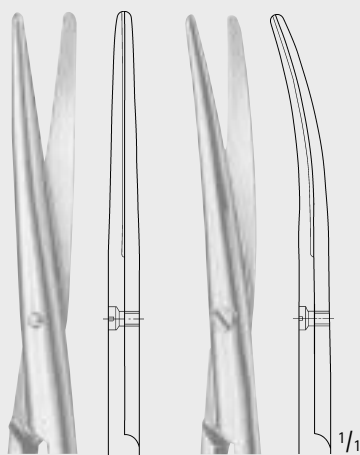

**BC600R**

**BC603R**

**BABY-METZENBAUM**

**BC600R-BC603R**

145 mm, 5 3/4"

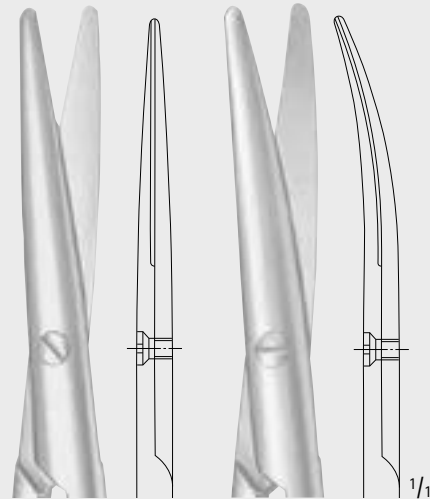

**BC680R**

**BC683R**

**METZENBAUM**

**BC680R-BC683R**

160 mm, 6 1/4"

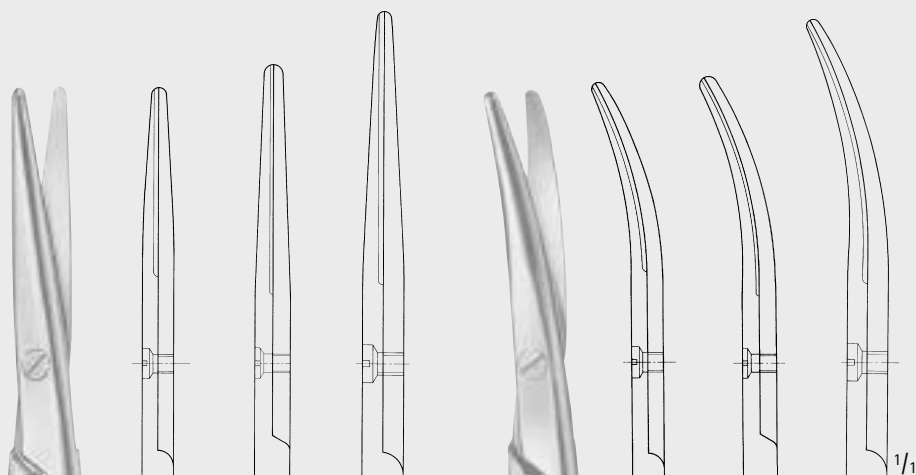

**BC601R**

**BC602R**

**BC604R**

145 mm

180 mm

200 mm

5 3/4"

7"

7 7/8"

**BC605R**

**BC606R**

**BC607R**

145 mm

180 mm

200 mm

5 3/4"

7"

7 7/8"

**METZENBAUM**

**BC601R-BC607R**

**Scissors – Scheren**  
 Dissecting Scissors  
 Präparierscheren

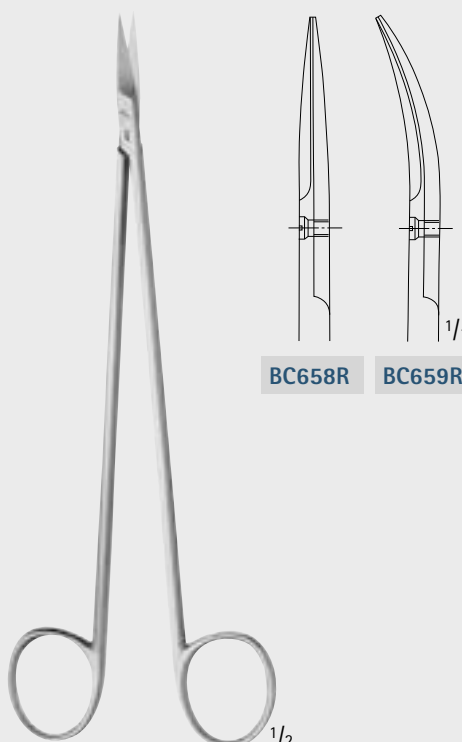

BC658R BC659R

**BC658R-BC659R**  
 very delicate  
 sehr fein  
 195 mm, 7 3/4"

1/2 1/1

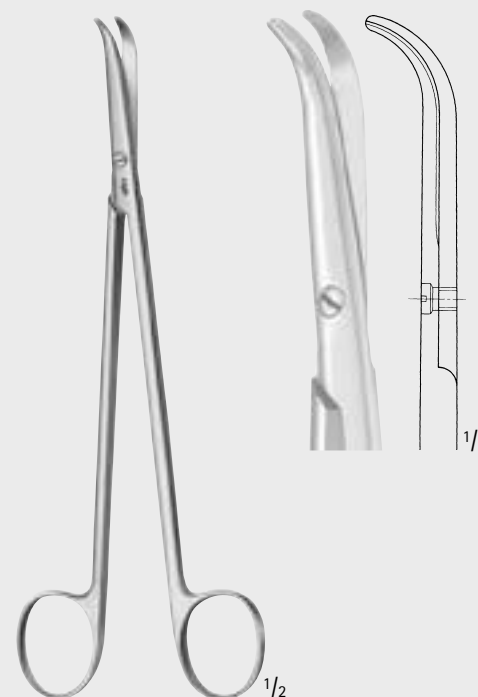

**THOREK**  
**BC636R**  
 180 mm, 7"

1/2 1/1

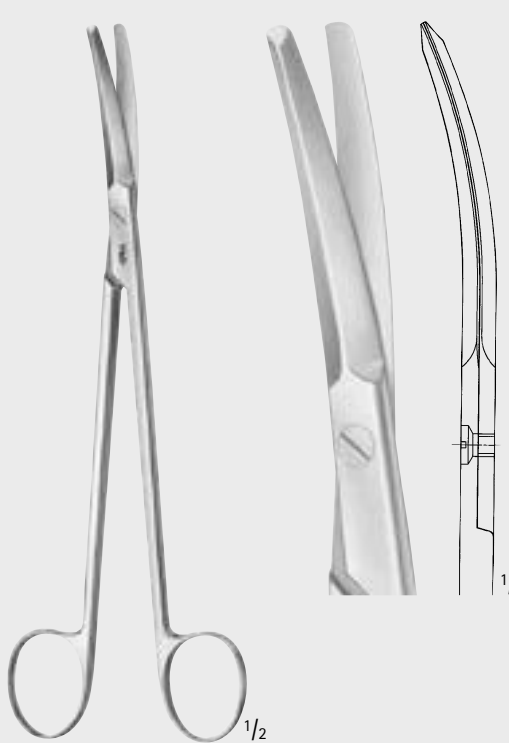

**POTTS-SMITH**  
**BC643R**  
 190 mm, 7 1/2"

1/2 1/1



**COOLEY**  
**BC597R**  
 190 mm, 7 1/2"

1/2 1/1

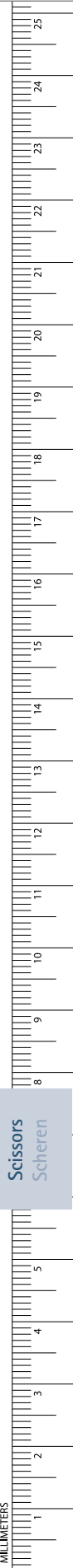

# Scissors – Scheren

## Ligature Scissors

### Ligaturscheren

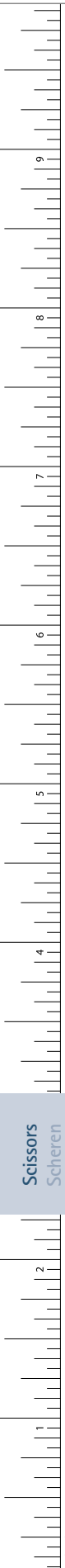

SPENCER

**BC801R-BC803R**



**BC801R**

90 mm  
3 1/2"



**BC802R**

115 mm  
4 1/2"



LITTAUER

**BC803R**

135 mm, 5 1/4"

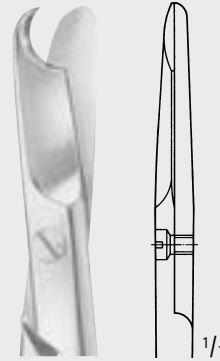

NORTHBENT

**BC805R**

120 mm, 4 3/4"

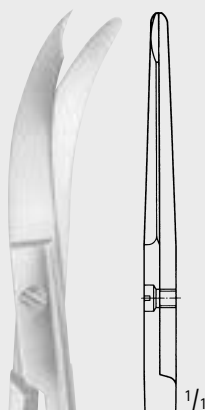

## Scissors – Scheren

### Bandage- and Cloth Scissors

### Verband- und Kleiderscheren

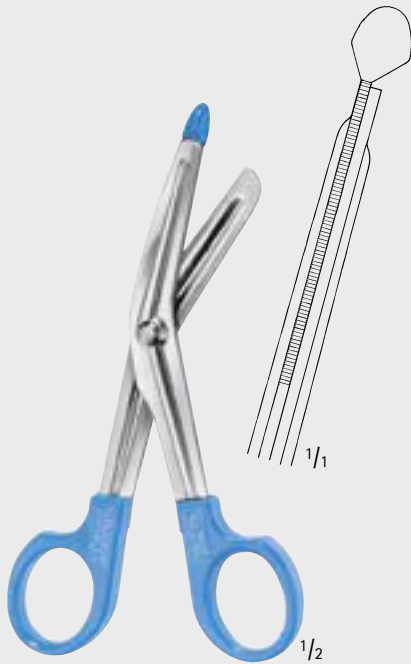
**LISTER**

Art. No. Art. Nr.	Handle color Grifffarbe
BC885R	black schwarz
BC970R	red rot
BC971R	blue blau
BC973R	yellow gelb
BC975R	orange orange
BC977R	pink pink
BC978R	light green hellgrün
BC979R	violet violett

Universal bandage and cloth scissors,  
with toothed edges,  
autoclavable up to 143 °C (3 bar)  
Universal Verband- und Kleiderstoffschere,  
mit gezahnten Schneiden,  
autoklavierbar bis 143 °C (3 bar)  
145 mm, 5 3/4"

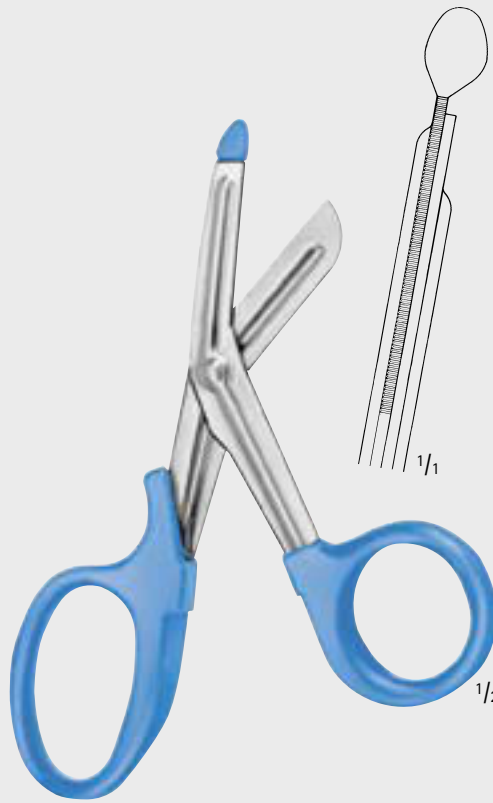

Art. No. Art. Nr.	Handle color Grifffarbe
BC881R	black schwarz
BC980R	red rot
BC981R	blue blau
BC983R	yellow gelb
BC985R	orange orange
BC987R	pink pink
BC988R	light green hellgrün
BC989R	violet violett

Universal bandage and cloth scissors,  
with toothed edges,  
autoclavable up to 143 °C (3 bar)  
Universal Verband- und Kleiderstoffschere,  
mit gezahnten Schneiden,  
autoklavierbar bis 143 °C (3 bar)  
180 mm, 7"

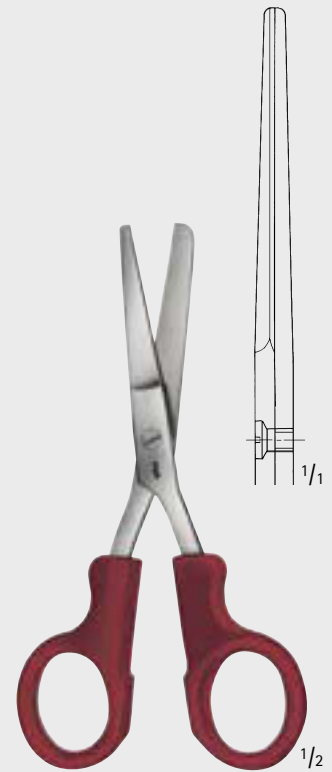
**BC890R**

Nurse's scissors,  
autoclavable up to 143 °C (3 bar)  
Schwesternschere,  
autoklavierbar bis 143 °C (3 bar)  
145 mm, 5 3/4"

## Scissors - Scheren

### Bandage- and Cloth Scissors

### Verband- und Kleiderscheren

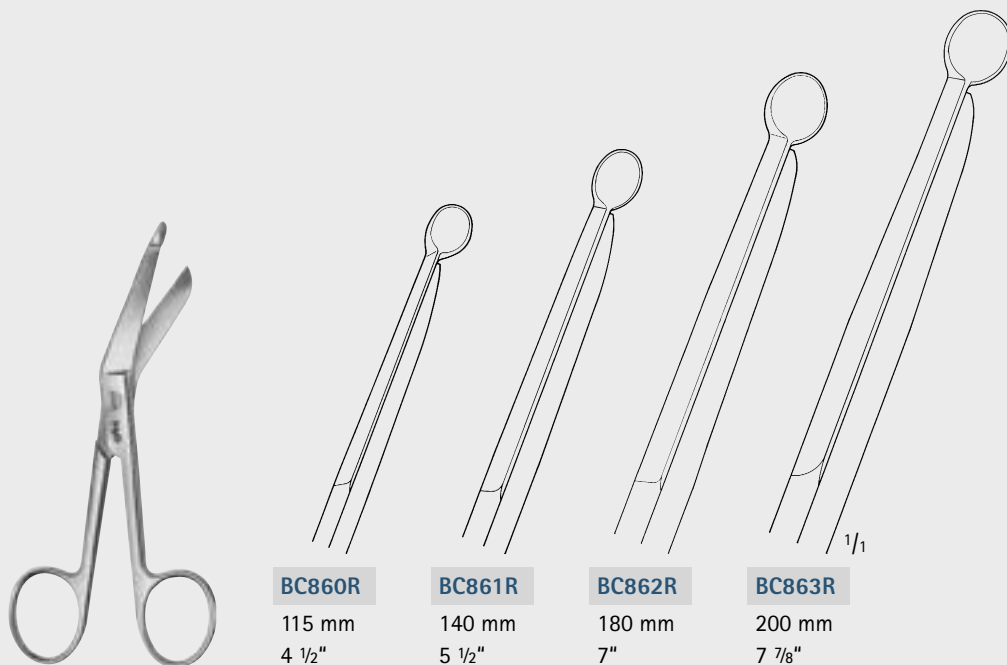

**BC860R**  
115 mm  
4 1/2"

**BC861R**  
140 mm  
5 1/2"

**BC862R**  
180 mm  
7"

**BC863R**  
200 mm  
7 7/8"

LISTER

**BC860R-BC863R**

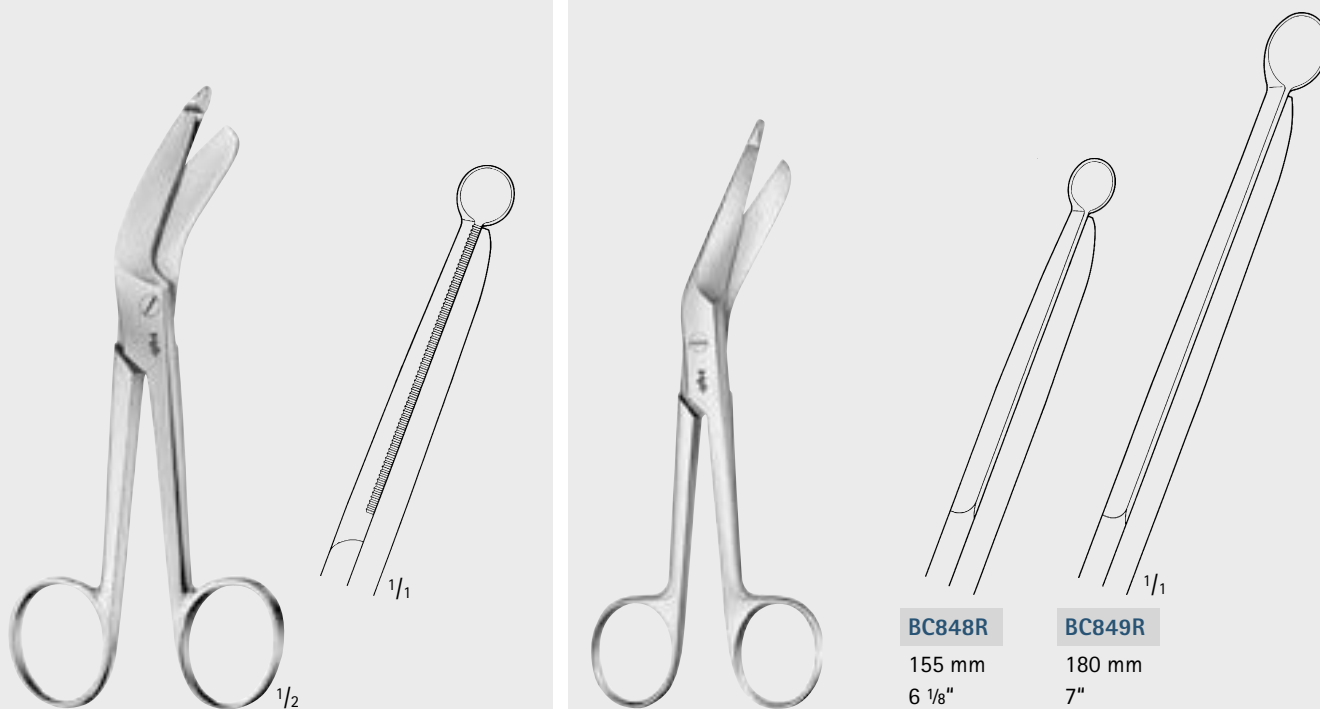

LISTER

**BC876R**

160 mm, 6 1/4"

LISTER

**BC848R-BC849R**

**BC848R**  
155 mm  
6 1/8"

**BC849R**  
180 mm  
7"



## General Surgical Instruments Chirurgische Instrumente

- Dissecting- and Tissue Forceps
- Pinzetten

# Forceps – Pinzetten

## Delicate Forceps

### Feine Pinzetten

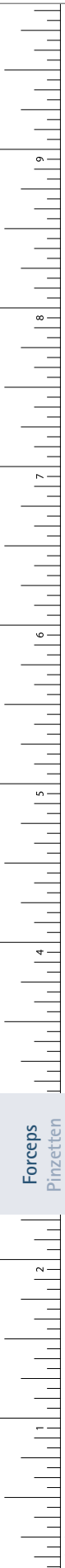

- Titanium
- Titan

1 mm

1/1

1/2

**MICRO-ADSON**  
**BD221T**  
Dissecting forceps  
Anatomische Pinzette  
120 mm, 4 3/4"

- Titanium
- Titan

1 mm

1/1

1/2

**MICRO-ADSON**  
**BD514T**  
Tissue forceps  
Chirurgische Pinzette  
120 mm, 4 3/4"

- Titanium
- Titan

1.5 mm

1/1

1/2

**MICRO-ADSON**  
**BD516T**  
Tissue forceps  
Chirurgische Pinzette  
120 mm, 4 3/4"

- ERGOPLANT

1/1

1/2

**DX050R**  
Tissue forceps  
Chirurgische Pinzette  
120 mm, 4 3/4"

- ERGOPLANT

1/1

with platform tip  
mit Plateau

1/2

**DX051R**  
Tissue forceps  
Chirurgische Pinzette  
120 mm, 4 3/4"

- ERGOPLANT

1/1

■ **DUROGRIP®**  
with tungsten  
carbide inserts  
mit Hartmetall-  
einlagen

1/2

**DX052R**  
Atraumatic forceps  
Atraumatische Pinzette  
120 mm, 4 3/4"

- ERGOPLANT

1/1

1/2

**DX055R**  
Soft tissue forceps  
Weichgewebepinzette  
140 mm, 5 1/2"

# Forceps – Pinzetten

## Delicate Dissecting Forceps

### Feine anatomische Pinzetten

1/2

1/1

**THORPE**  
**OC069R**  
120 mm, 4 3/4"

1/2

1/1

with platform tip  
mit Plateau

**MICRO-ADSON**  
**BD220R**  
120 mm, 4 3/4"

1/2

1/1

**ADSON**  
**BD222R**  
120 mm, 4 3/4"

1/2

1/1

**HUDSON**  
**BD225R**  
125 mm, 5"

1/2

1/1

**MICRO-ADSON**  
**BD223R**  
150 mm, 6"

1/2

1/1

**ADSON**  
**BD224R**  
180 mm, 7"

1/2

1/1

**JEFFERSON**  
**BD226R**  
180 mm, 7"

1/2

1/1

**OC020R** **OC021R** **OC022R**

**OC020R-OC022R**  
Iris forceps  
Iris Pinzette  
100 mm, 4"

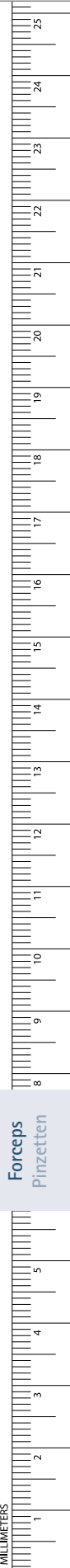

# Forceps – Pinzetten

## Delicate Dissecting Forceps

Feine anatomische Pinzetten

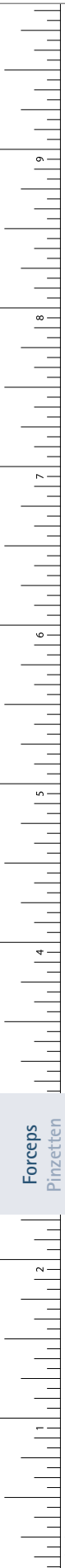

Model	Length (mm)	Length (inches)
BD301R	90 mm	3 1/2"
BD302R	105 mm	4 1/8"
BD303R	115 mm	4 1/2"
BD304R	130 mm	5 1/8"
BD305R	145 mm	5 3/4"
BD311R	90 mm	3 1/2"
BD312R	105 mm	4 1/8"
BD313R	115 mm	4 1/2"
BD314R	130 mm	5 1/8"
BD315R	145 mm	5 3/4"

**BD301R–BD315R**

**BD210R**  
115 mm, 4 1/2"

**BD320R**  
100 mm, 4"

**BD321R**  
100 mm, 4"

Forceps  
Pinzetten

# Forceps – Pinzetten

## Dissecting Forceps

### Anatomische Pinzetten

**SEMKEN**  
**BD215R–BD216R**

**BD215R**  
125 mm  
5"

**BD216R**  
150 mm  
6"

**BD217R**  
155 mm, 6 1/8"

**GILLIES**  
**BD213R**  
150 mm, 6"

**MC INDOE**  
**BD236R**  
150 mm, 6"

**GERALD**  
**BD228R–BD230R**

**BD228R**  
175 mm  
6 7/8"

**BD229R**  
175 mm  
6 7/8"

**BD230R**  
230 mm  
9"

■ Titanium  
■ Titan

1.5 mm

**GERALD**  
**BD227T**  
170 mm, 6 3/4"

■ Titanium  
■ Titan

1.5 mm

**GERALD**  
**BD657T**  
170 mm, 6 3/4"

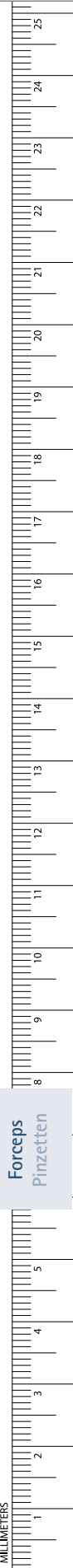

# Forceps – Pinzetten

## Dissecting Forceps

### Anatomische Pinzetten



<b>BD268R</b>	<b>BD269R</b>
175 mm	215 mm
6 7/8"	8 1/2"

**CAIRNS-DOTT**  
**BD268R-BD269R**

<b>BD238R</b>	<b>BD239R</b>	<b>BD243R</b>
180 mm	200 mm	200 mm
7"	7 7/8"	7 7/8"

**CUSHING**  
**BD238R-BD243R**

**BD246R**

**BROPHY**  
**BD246R**

1/2 200 mm, 7 7/8"

Forceps  
Pinzetten

# Forceps – Pinzetten

## Dissecting Forceps

### Anatomische Pinzetten

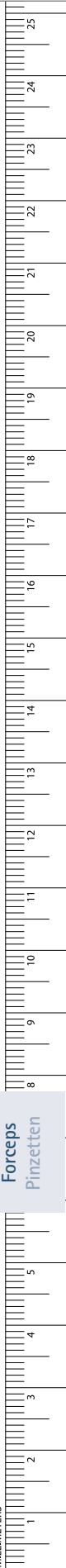
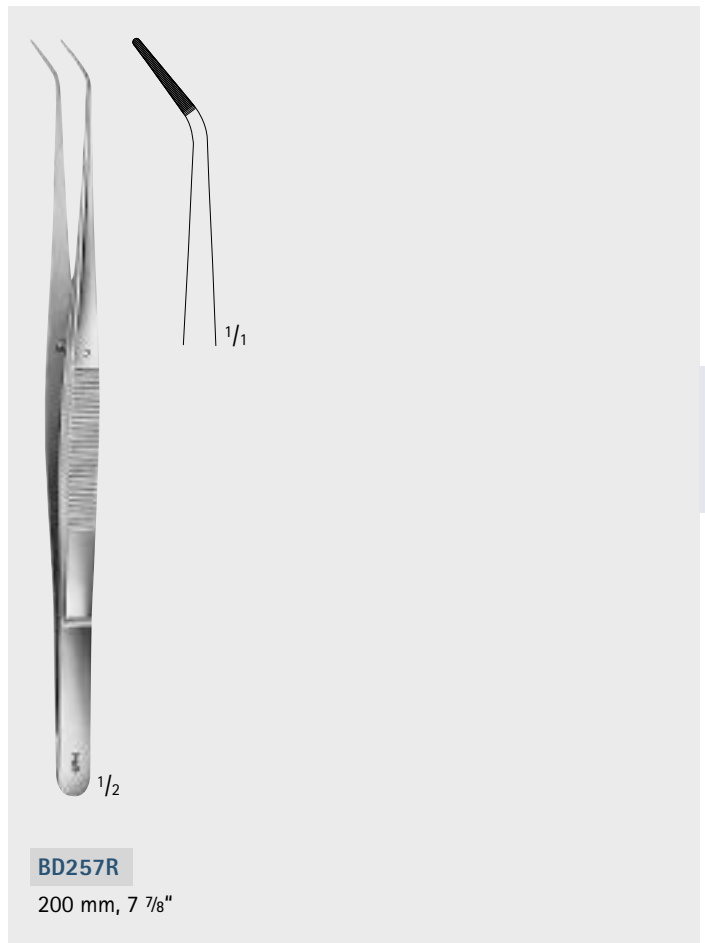
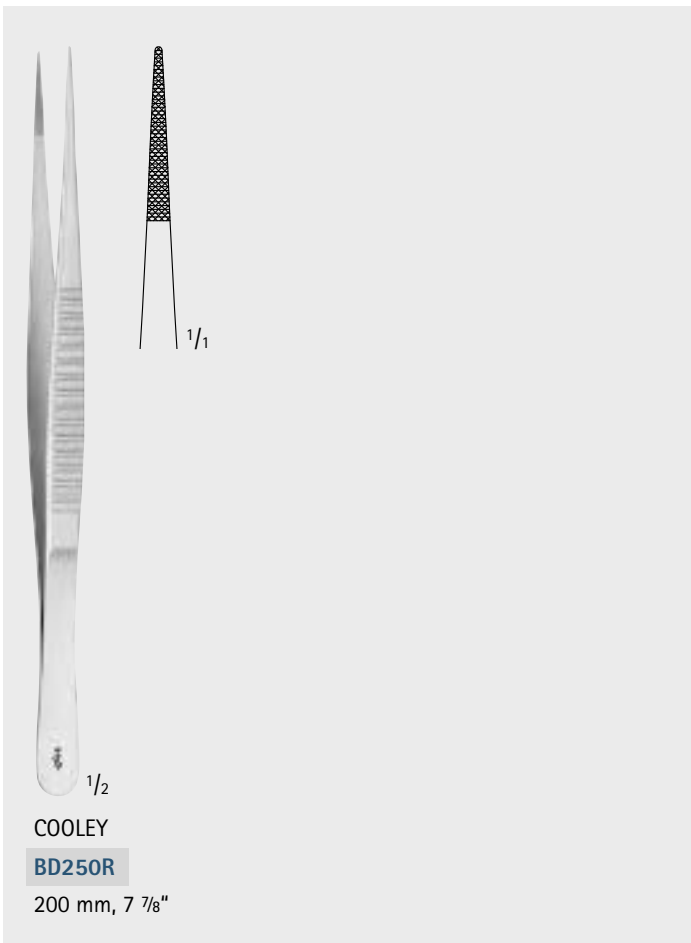
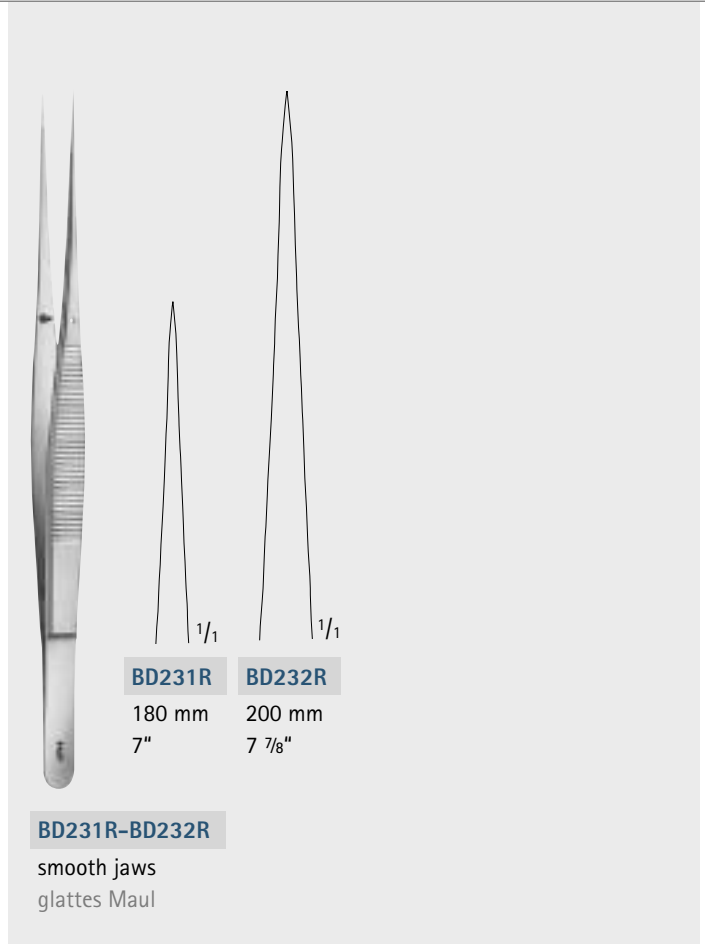
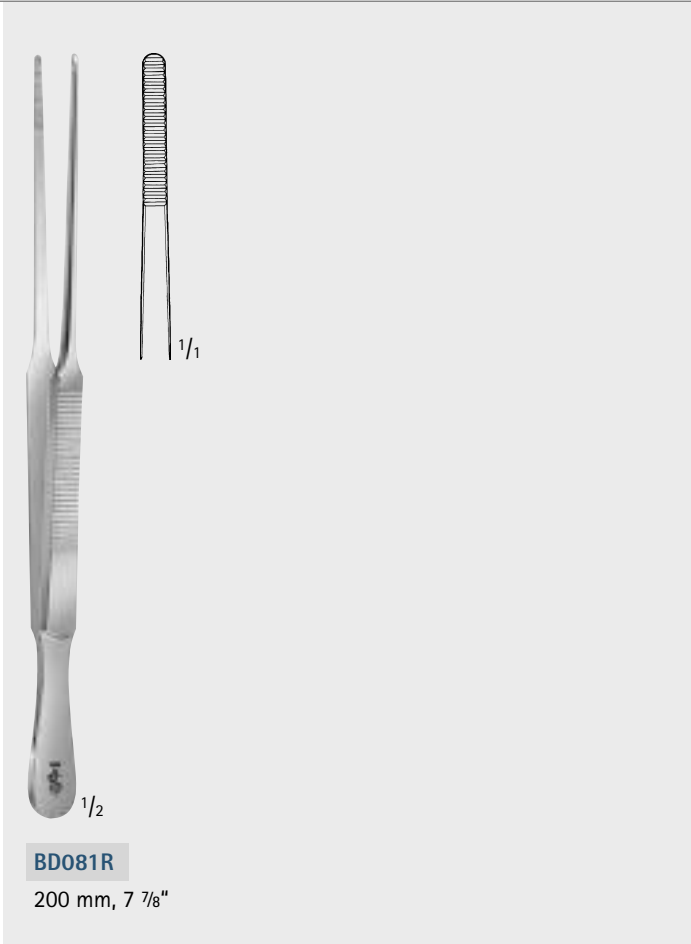

# Forceps – Pinzetten

## Dissecting Forceps

### Anatomische Pinzetten

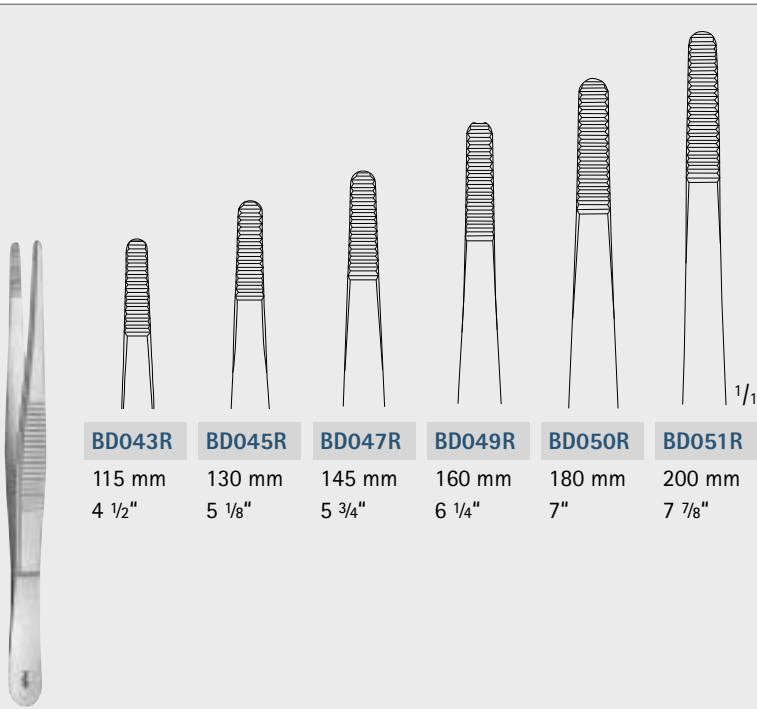

<b>BD043R</b>	<b>BD045R</b>	<b>BD047R</b>	<b>BD049R</b>	<b>BD050R</b>	<b>BD051R</b>
115 mm 4 1/2"	130 mm 5 1/8"	145 mm 5 3/4"	160 mm 6 1/4"	180 mm 7"	200 mm 7 7/8"

**BD043R-BD051R**  
Standard patterns  
Standard-Modelle

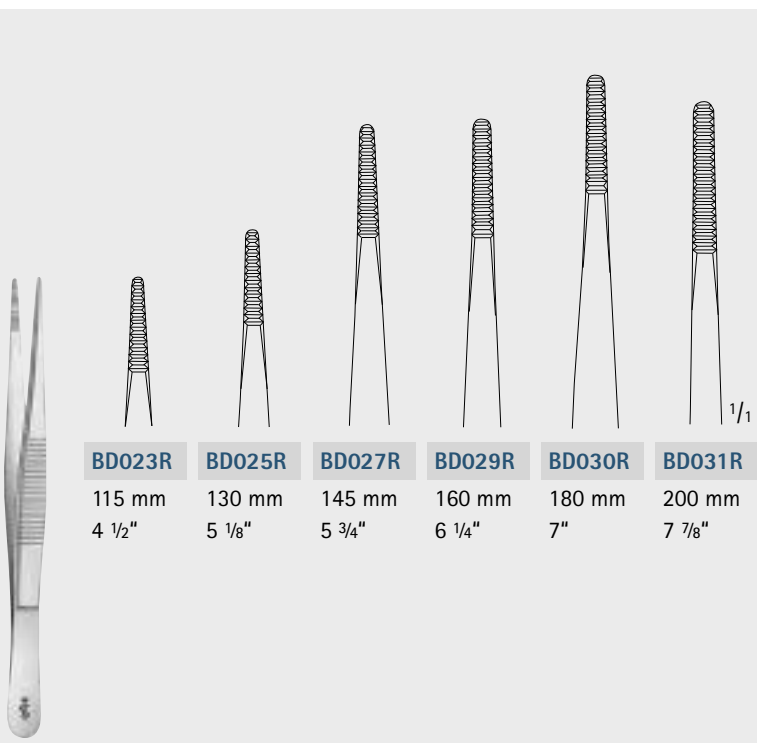

<b>BD023R</b>	<b>BD025R</b>	<b>BD027R</b>	<b>BD029R</b>	<b>BD030R</b>	<b>BD031R</b>
115 mm 4 1/2"	130 mm 5 1/8"	145 mm 5 3/4"	160 mm 6 1/4"	180 mm 7"	200 mm 7 7/8"

**BD023R-BD031R**  
medium  
mittelbreit



# Forceps – Pinzetten

## Dissecting Forceps

### Anatomische Pinzetten

**BD035R**  
130 mm  
5 1/8"

**BD037R**  
140 mm  
5 1/2"

**BD035R-BD037R**  
medium  
mittelbreit

**BD077R**  
extra large  
extra breit  
145 mm, 5 3/4"

BD065R	BD067R	BD068R	BD069R
130 mm	150 mm	170 mm	200 mm
5 1/8"	6"	6 3/4"	7 7/8"

**SWEDISH PATTERN**  
**SCHWEDISCHES MODELL**

**BD065R-BD069R**

**OCHSNER**  
**BD130R**  
Ligature forceps  
Fadenpinzette  
145 mm, 5 3/4"

**BONNEY**  
**BD078R**  
175 mm, 6 7/8"

**RAMSEY**  
**BD083R**  
180 mm, 7"

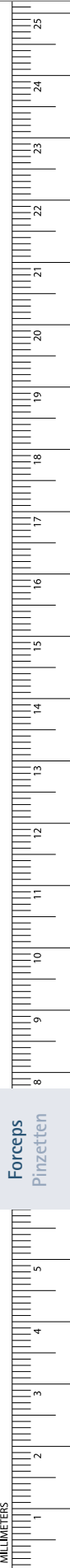

# Forceps – Pinzetten

## Atraumatic Forceps

### Atraumatische Pinzetten



#### ■ ATRAUMATA®

Toothing DE BAKEY



DE BAKEY Zahnung

#### ■ ATRAUMATA®

Toothing COOLEY



COOLEY Zahnung

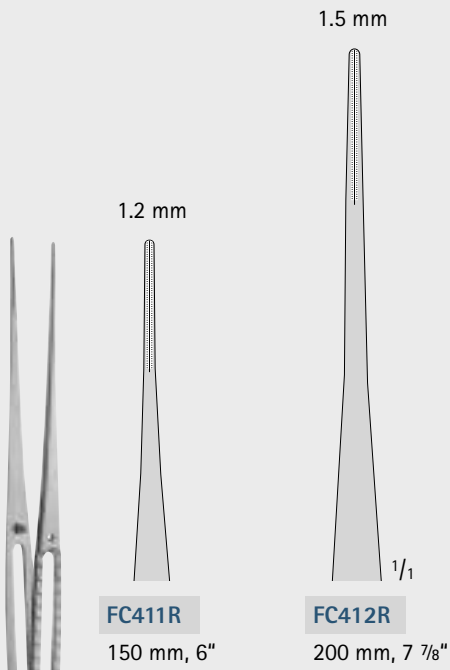

**FC411R**

150 mm, 6"

**FC412R**

200 mm, 7 7/8"

DE BAKEY

**FC411R-FC412R**

Ultra-Light forceps

Ultra-Light Pinzetten

#### ■ ERGOPLANT



**DX303R**

Micro forceps

Mikro-Pinzette

180 mm, 7"

# Forceps – Pinzetten

## Atraumatic Forceps

### Atraumatische Pinzetten

- Titanium
- Titan
- ATRAUMATA®
- Toothing DE BAKEY
- 
- DE BAKEY Zahnung



1.5 mm

1/1

1/2

DE BAKEY

**FB387T**

145 mm, 5 3/4"



1.5 mm

1/1

1/2

DE BAKEY

**FB388T**

195 mm, 7 3/4"



2.5 mm

1/1

1/2

DE BAKEY

**FB390T**

145 mm, 5 3/4"



2.5 mm

1/1

1/2

DE BAKEY

**FB391T**

195 mm, 7 3/4"

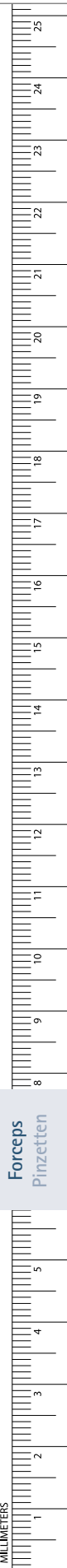

# Forceps – Pinzetten

## Atraumatic Forceps



## Atraumatische Pinzetten

■ ATRAUMATA®

Toothing DE BAKEY

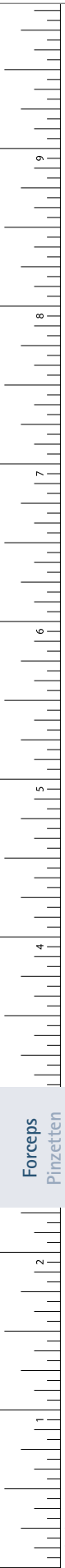

DE BAKEY Zahnung



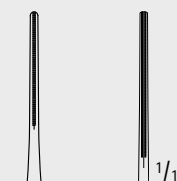

1 mm      1 mm



**FB394R**    **FB395R**  
 150 mm    195 mm  
 6"        7 3/4"

DE BAKEY  
**FB394R-FB395R**



1.5 mm      1.5 mm

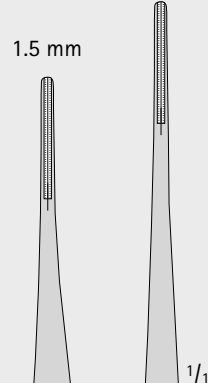

**FB411R**    **FB412R**  
 150 mm    200 mm  
 6"        7 7/8"

DE BAKEY  
**FB411R-FB412R**



2 mm      2 mm

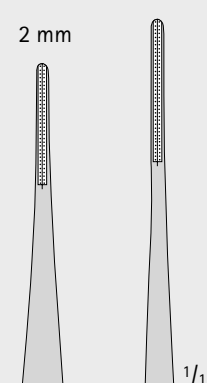

**FB400R**    **FB402R**  
 150 mm    200 mm  
 6"        7 7/8"

DE BAKEY  
**FB400R-FB402R**



2.8 mm      2.8 mm

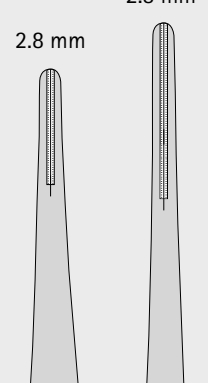

**FB414R**    **FB415R**  
 150 mm    200 mm  
 6"        7 7/8"

DE BAKEY  
**FB414R-FB415R**

Forceps  
Pinzetten

# Forceps – Pinzetten

## Atraumatic Forceps

### Atraumatische Pinzetten

■ ATRAUMATA®

Toothing DE BAKEY



DE BAKEY Zahnung

■ ATRAUMATA®

Toothing COOLEY



COOLEY Zahnung

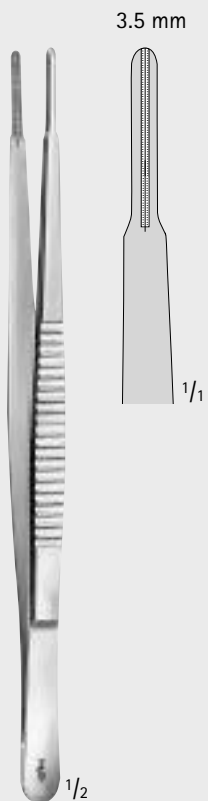

DE BAKEY

**FB406R**

200 mm, 7 7/8"

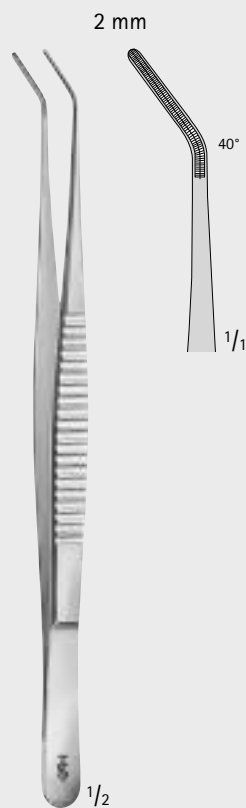

DE BAKEY

**FB403R**

200 mm, 7 7/8"

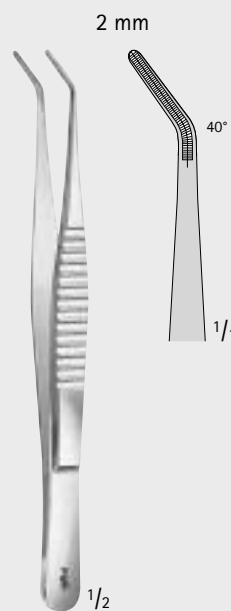

DE BAKEY

**FB401R**

150 mm, 6"

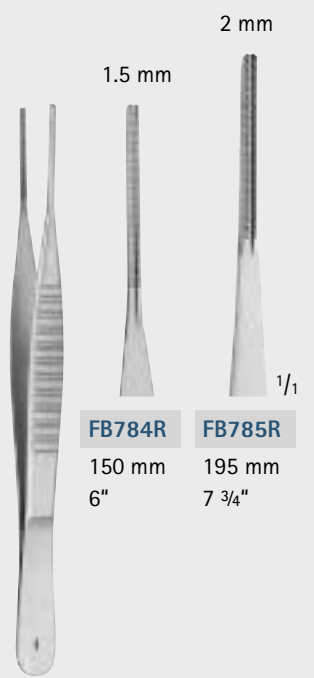

COOLEY

**FB784R-FB785R**

**FB784R**

150 mm  
6"

**FB785R**

195 mm  
7 3/4"

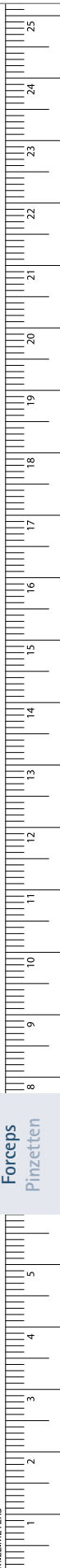

## Forceps – Pinzetten

DUROGRIP® Dissecting forceps

DUROGRIP® Pinzetten

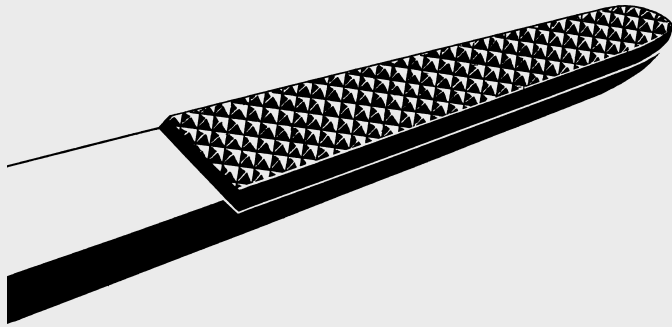

- Precisely worked out fine structure of carbide inserts
- Thus firm and non-traumatic gripping of tissue
- Universal in use – long working life
- Fein strukturiertes und präzise gearbeitetes Haftprofil
- Sicheres und zugleich schonendes Fassen
- Universell verwendbar – unverwüsthlich im Gebrauch



- DUROGRIP® Dissecting forceps with tungsten carbide inserts
  - Identification: gold-plated end
- DUROGRIP® Pinzetten mit Hartmetall-Plättchen
  - Kennzeichnung: vergoldete Feder

Forceps  
Pinzetten

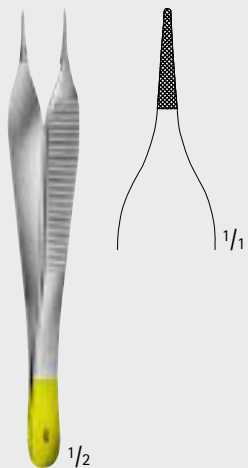

ADSON  
**BD151R**  
120 mm, 4 3/4"

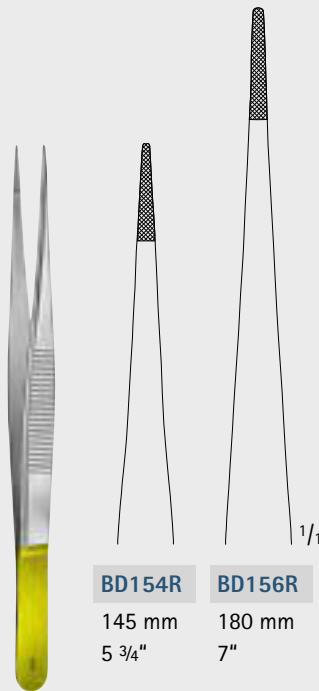

**BD154R**    **BD156R**  
145 mm    180 mm  
5 3/4"    7"

**BD154R-BD156R**

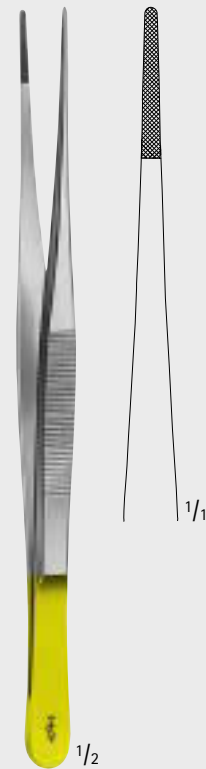

**BD157R**  
200 mm, 7 7/8"

# Forceps - Pinzetten

## DUROGRIP® Dissecting forceps

### DUROGRIP® Pinzetten



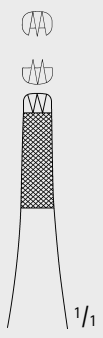

Cushion shaped tip ensures a safe and gentle grasping of the thread  
 Besonders sicheres und schonendes Fassen des Fadens durch kissenförmige Maulform

**BD180R**  
 200 mm, 7 7/8"

**FERRIS-SMITH**  
**BD181R**  
 175 mm, 6 7/8"

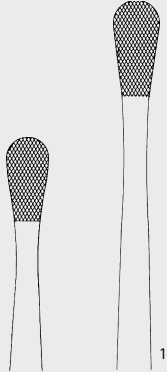
**BD171R** 150 mm, 6"  
**BD173R** 230 mm, 9"

**WANGENSTEEN**  
**BD171R-BD173R**





**BD164R** 145 mm, 5 3/4"  
**BD165R** 200 mm, 7 7/8"

**STANDARD**  
**BD164R-BD165R**





**BD160R** 180 mm, 7"  
**BD198R** 250 mm, 9 3/4"

**CUSHING**  
**BD160R-BD198R**  
 with scraper end  
 mit Schaber

**BD168R** 185 mm, 7 1/4"

**GRUENWALD**  
**BD168R**

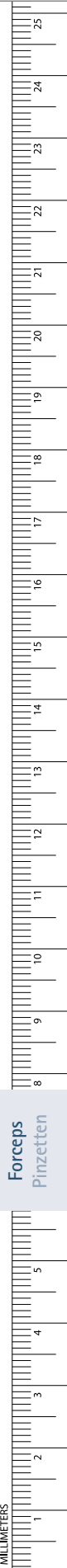

# Forceps – Pinzetten

## Forceps, Bayonet-Shaped

Pinzetten, bajonettförmig gebogen



**LUCAE**  
**BD878R**  
140 mm, 5 1/2"

**LUCAE**  
**BD879R**  
140 mm, 5 1/2"

**COTTLE**  
**OL011R**  
140 mm, 5 1/2"

**JANSEN**  
**BD880R**  
160 mm, 6 1/4"

**ADSON**  
**BD870R**  
175 mm, 6 7/8"

Forceps  
Pinzetten



# Forceps - Pinzetten

## Forceps, Bayonet-Shaped

### Pinzetten, bajonettförmig gebogen

1/2

1/1

**GRUENWALD**  
**BD883R**  
200 mm, 7 7/8"

1/2

1/1

smooth jaw  
glattes Maul

**BD887R**  
160 mm, 6 1/4"

1/2

1/1

1 x 2 teeth  
1 x 2 Zähne

**BD888R**  
160 mm, 6 1/4"

1/2

1/1

smooth jaw  
glattes Maul

**BD885R**  
185 mm, 7 1/4"

1/2

1/1

1 x 2 teeth  
1 x 2 Zähne

**BD886R**  
200 mm, 7 7/8"

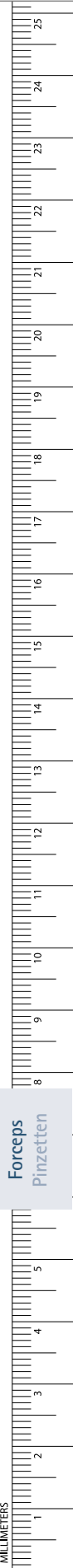

# Forceps – Pinzetten

## Forceps, Angular

### Pinzetten, kniegebogen

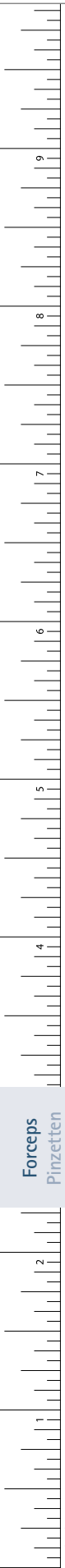

1/1  
1/2

TROELTSCH  
**BD900R**  
100 mm, 4"

1/1  
1/2

TROELTSCH  
**BD902R**  
115 mm, 4 1/2"

1 x 2 teeth  
1 x 2 Zähne  
1/1  
1/2

TROELTSCH  
**BD903R**  
115 mm, 4 1/2"

1/1  
1/2

WILDE  
**BD904R**  
115 mm, 4 1/2"

1/1  
1/2

TROELTSCH  
**BD905R**  
cross action  
selbstschließend  
120 mm, 4 3/4"

1/1  
1/2

TROELTSCH  
**BD910R**  
140 mm, 5 1/2"

1/1  
1/2

TROELTSCH  
**BD911R**  
170 mm, 6 3/4"

# Forceps – Pinzetten

## Delicate Tissue Forceps

### Feine chirurgische Pinzetten

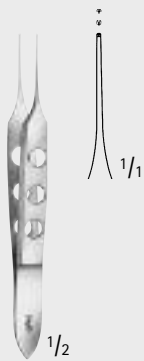

1/2 1/1

**BISHOP-HARMON**  
**OC051R**  
 85 mm, 3 1/4"

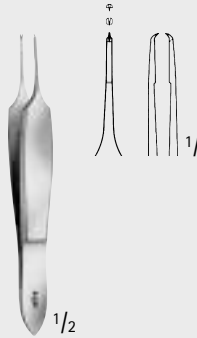

1/2 1/1

**ST. MARTIN**  
**OC091R**  
 80 mm, 3 1/8"

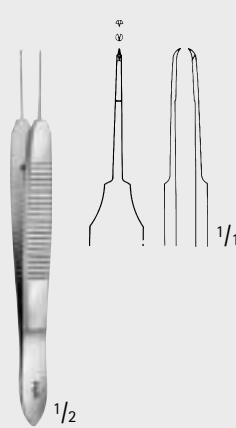

1/2 1/1

**CASTROVIEJO**  
**OC094R**  
 100 mm, 4"

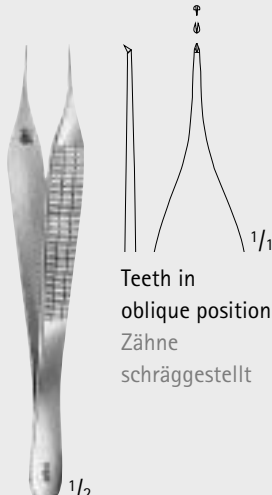

1/2 1/1

Teeth in oblique position  
 Zähne schräggestellt

**MICRO-ADSON-BIEMER**  
**BD509R**  
 120 mm, 4 3/4"

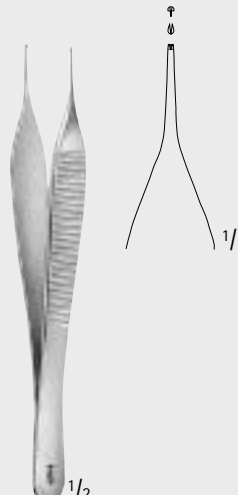

1/2 1/1

**MICRO-ADSON**  
**BD510R**  
 120 mm, 4 3/4"

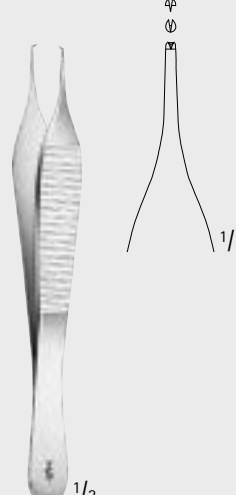

1/2 1/1

**ADSON**  
**BD511R**  
 120 mm, 4 3/4"



1/2 1/1

with platform tip  
 mit Plateau

**ADSON**  
**BD512R**  
 120 mm, 4 3/4"

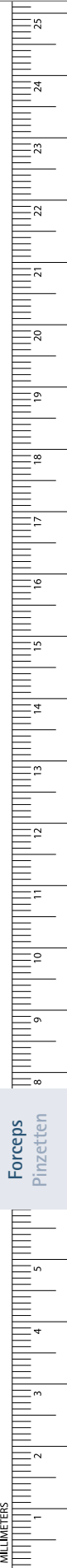

Forceps  
Pinzetten

# Forceps – Pinzetten

## Delicate Tissue Forceps

### Feine chirurgische Pinzetten

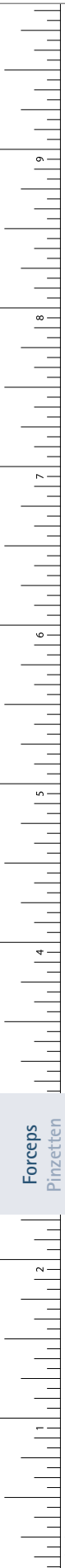

MICRO-ADSON  
**BD520R**  
150 mm, 6"

ADSON  
**BD522R**  
180 mm, 7"

JEFFERSON  
**BD523R**  
180 mm, 7"

ADSON  
**BD508R**  
120 mm, 4 3/4"

ADSON  
**BD513R**  
120 mm, 4 3/4"  
with platform tip  
mit Plateau

ADSON  
**BD506R**  
120 mm, 4 3/4"

ADSON  
**BD507R**  
120 mm, 4 3/4"

ADSON  
**BD521R**  
150 mm, 6"

# Forceps – Pinzetten

## Delicate Tissue Forceps

### Feine chirurgische Pinzetten

**HUDSON**  
**MB291R**  
125 mm, 5"

**ADSON**  
**MB454R**  
120 mm, 4 3/4"

**ADSON-BROWN**  
**BD700R**  
Tissue forceps, sharp  
Hautpinzette, scharf  
120 mm, 4 3/4"

**BROWN**  
**BD701R-BD702R**  
150 mm 6"  
200 mm 7 7/8"

**GRAEFFE**  
**OC100R**  
110 mm, 4 1/4"

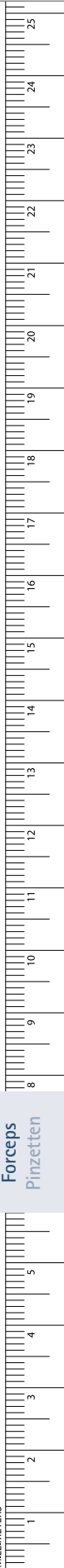

# Forceps – Pinzetten

## Delicate Tissue Forceps

### Feine chirurgische Pinzetten



**OC024R** **OC025R** **OC026R**

**OC024R-OC026R**  
 very delicate  
 sehr fein  
 100 mm, 4"

**BD500R**  
 100 mm, 4"

**BD501R**  
 110 mm, 4 1/4"

**Forceps**  
**Pinzetten**

**BD502R**  
 110 mm, 4 1/4"

**BD665R** **BD666R** **BD667R**

125 mm 125 mm 150 mm  
 5" 5" 6"

2 x 3 teeth  
 2 x 3 Zähne

**SEMKEN**  
**BD665R-BD667R**

**BD668R** **BD669R**

125 mm 145 mm  
 5" 5 3/4"

**SEMKEN**  
**BD668R-BD669R**

# Forceps – Pinzetten

## Delicate Tissue Forceps

### Feine chirurgische Pinzetten

**GILLIES**  
**BD660R**  
 155 mm, 6 1/8"

**MC INDOE**  
**BD661R**  
 150 mm, 6"

**GERALD**  
**BD662R-BD663R**  
 175 mm, 6 7/8"

**WAUGH**  
**BD670R-BD671R**  
 180 mm 7"  
 200 mm 7 7/8"

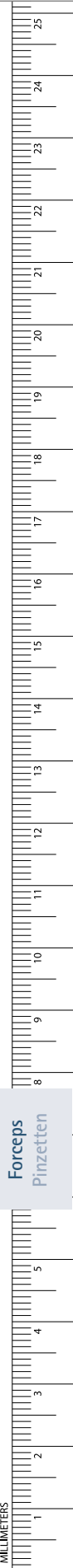

# Forceps – Pinzetten

## Tissue Forceps

### Chirurgische Pinzetten



Forceps  
Pinzetten

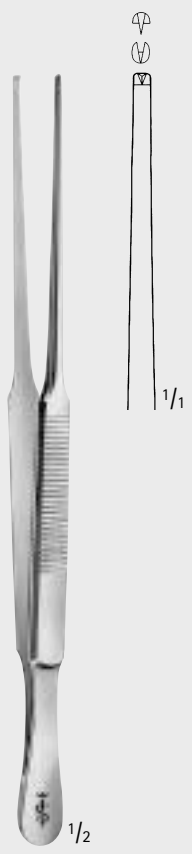

**BD651R**

200 mm, 7 7/8"



**CUSHING**

**MD463**

180 mm, 7"



# Forceps – Pinzetten

## Tissue Forceps

### Chirurgische Pinzetten



<b>BD552R</b>	<b>BD553R</b>	<b>BD555R</b>	<b>BD557R</b>	<b>BD559R</b>	<b>BD560R</b>	<b>BD561R</b>
105 mm	115 mm	130 mm	145 mm	160 mm	180 mm	200 mm
4 1/8"	4 1/2"	5 1/8"	5 3/4"	6 1/4"	7"	7 7/8"

**BD552R-BD561R**

Standard patterns  
Standard-Modelle



<b>BD533R</b>	<b>BD535R</b>	<b>BD537R</b>	<b>BD527R</b>	<b>BD539R</b>	<b>BD540R</b>	<b>BD541R</b>
115 mm	130 mm	145 mm	145 mm	160 mm	180 mm	200 mm
4 1/2"	5 1/8"	5 3/4"	5 3/4"	6 1/4"	7"	7 7/8"

**BD533R-BD541R**

medium  
mittelbreit

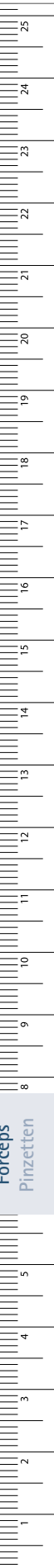

Forceps  
Pinzetten

# Forceps – Pinzetten

## Tissue Forceps

### Chirurgische Pinzetten



**BD547R** 145 mm 5 3/4"

**BD549R** 160 mm 6 1/4"

**BD547R-BD549R**

**BD600R** 145 mm, 5 3/4"

**BD575R** 130 mm 5 1/8"

**BD577R** 145 mm 5 3/4"

**BD579R** 160 mm 6 1/4"

**BD580R** 180 mm 7"

**BD581R** 200 mm 7 7/8"

**BD575R-BD581R**

2 x 3 teeth  
2 x 3 Zähne

# Forceps – Pinzetten

## Tissue Forceps

### Chirurgische Pinzetten

**BD587R**  
145 mm  
5 3/4"

**BD589R**  
160 mm  
6 1/4"

**BD591R**  
200 mm  
7 7/8"

**BD587R-BD591R**  
3 x 4 teeth  
3 x 4 Zähne

**BD597R**  
145 mm, 5 3/4"

4 x 5 teeth  
4 x 5 Zähne

**BD598R**  
150 mm, 6"

OFFICER

4 x 5 teeth  
4 x 5 Zähne

**BD602R**  
125 mm  
5"

**BD603R**  
145 mm  
5 3/4"

**BD604R**  
145 mm  
5 3/4"

**BD606R**  
175 mm  
6 7/8"

**BD607R**  
180 mm  
7"

**BD602R-BD607R**  
LANE

2 x 3 teeth  
2 x 3 Zähne

2 x 3 teeth  
2 x 3 Zähne

2 x 3 teeth  
2 x 3 Zähne

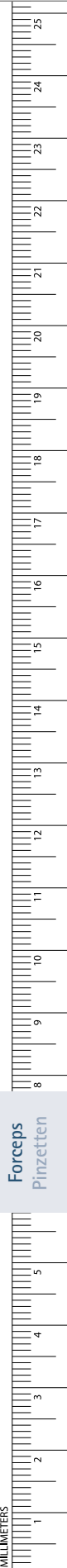

# Forceps – Pinzetten

## Tissue Forceps

### Chirurgische Pinzetten

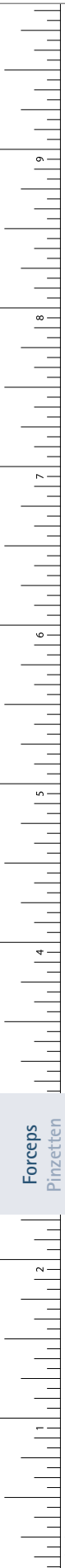

**STRASSBURGER MODELL**  
**BD690R–BD692R**

<b>BD690R</b>	<b>BD692R</b>
150 mm	200 mm
6"	7 7/8"

**ADLERKREUTZ**  
**BD735R–BD736R**

Vascular and tumor forceps  
 Gefäß- und Tumorpinzette

<b>BD735R</b>	<b>BD736R</b>
4 x 5 teeth	4 x 5 teeth
4 x 5 Zähne	4 x 5 Zähne
145 mm	200 mm
5 3/4"	7 7/8"

**STILLE-BARRAYA**  
**BD725R–BD726R**

<b>BD725R</b>	<b>BD726R</b>
3 x 4 teeth	3 x 4 teeth
3 x 4 Zähne	3 x 4 Zähne
180 mm	200 mm
7"	7 7/8"

**RUSS. MODELL**  
**BD755R**

150 mm, 6"

**RUSS. MODELL**  
**BD760R**

200 mm, 7 7/8"

**SELMAN**  
**BD750R**

155 mm, 6 1/8"

Forceps  
Pinzetten

# Forceps – Pinzetten

## Splinter Forceps

### Splitterpinzetten



**BD952R**

Splinter forceps  
Splitterpinzette  
80 mm, 3 1/8"



**BD963R**

75 mm  
3"



**BD964R**

95 mm  
3 3/4"



**BD965R**

115 mm  
4 1/2"



FEILCHENFELD

**BD963R–BD965R**

Splinter forceps  
Splitterpinzetten

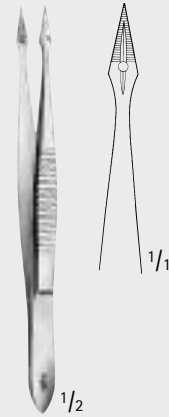

HUNTER

**BD980R**

105 mm, 4 1/8"

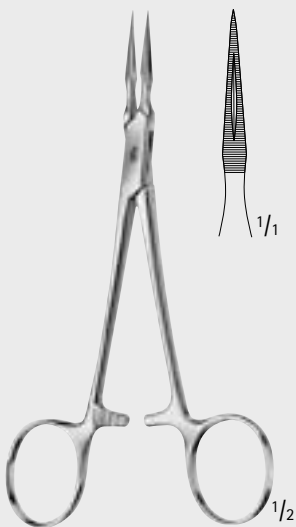

STIEGLITZ

**BD992R**

Splinter forceps  
Splitterzange  
140 mm, 5 1/2"

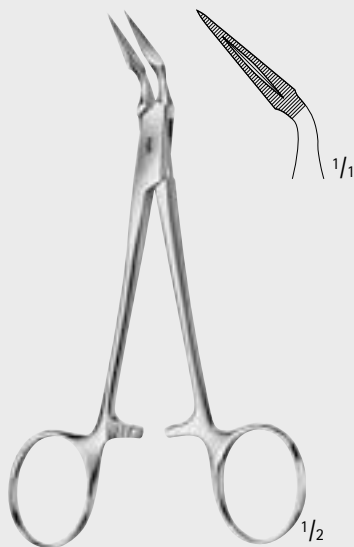

STIEGLITZ

**BD993R**

Splinter forceps  
Splitterzange  
140 mm, 5 1/2"

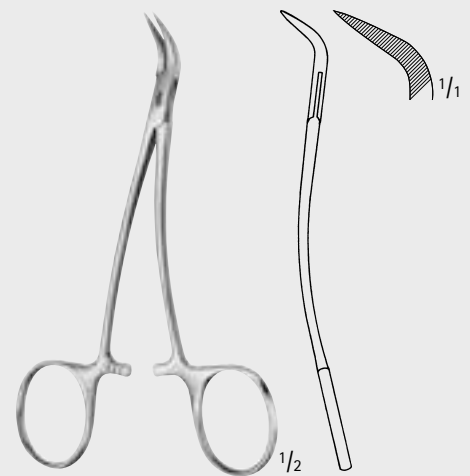

PEET

**BD995R**

Splinter forceps  
Splitterzange  
120 mm, 4 3/4"

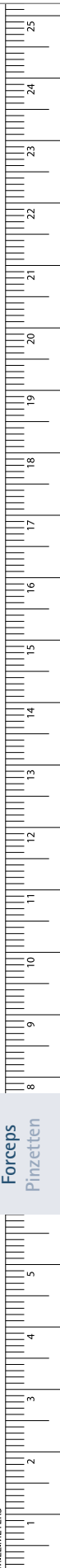

# Forceps - Pinzetten



**Forceps**  
Pinzetten

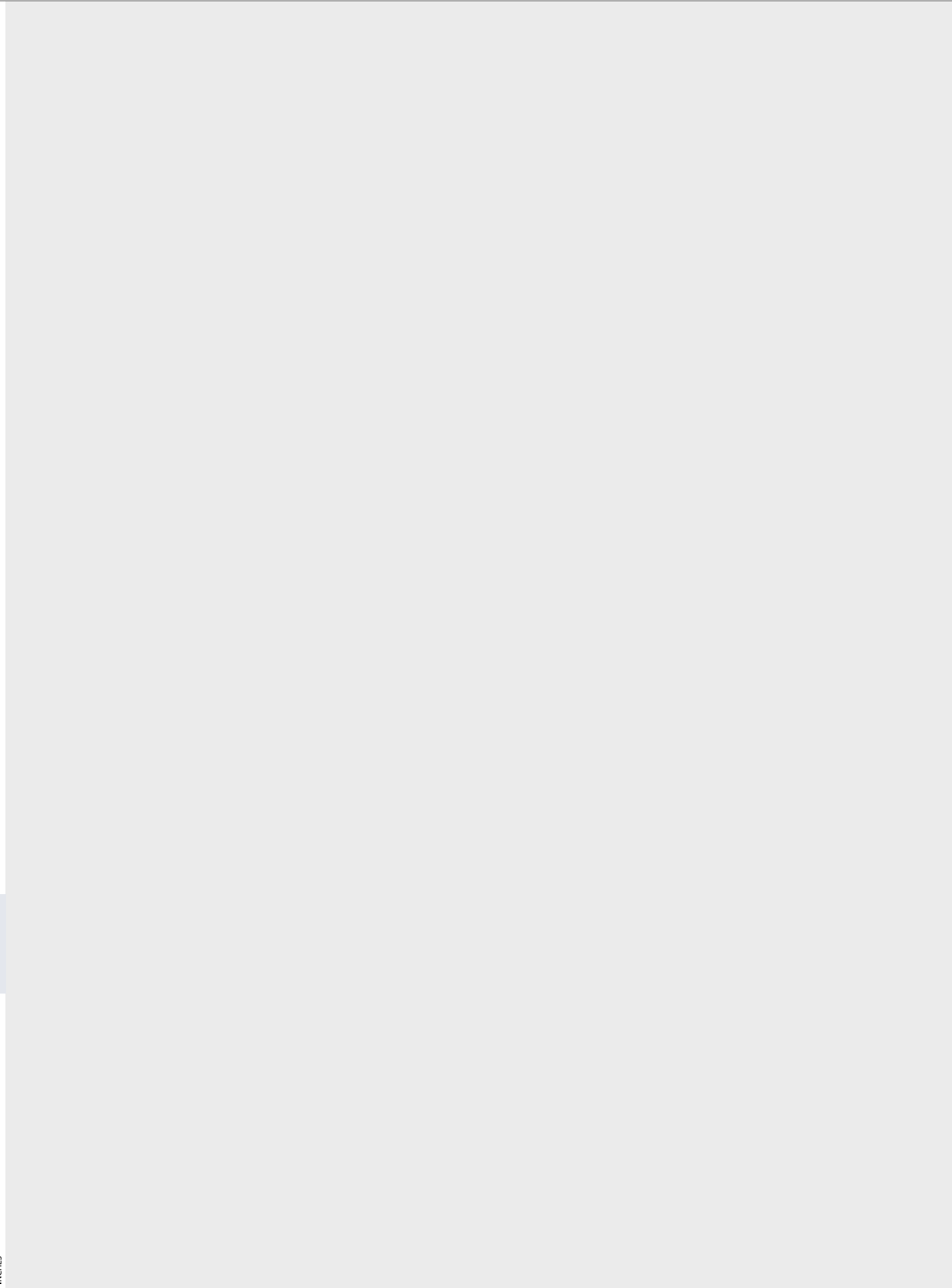

## General Surgical Instruments Chirurgische Instrumente

- Clamps
- Klemmen

# Clips, Clamps – Clips, Klemmen

## Vessel Clips

### Gefäßclips

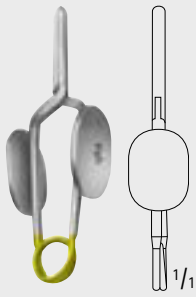

FE010K, FE020K

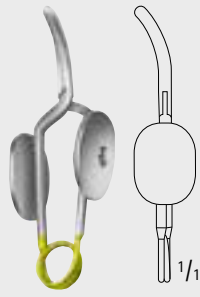

FE011K, FE021K



FE012K, FE022K

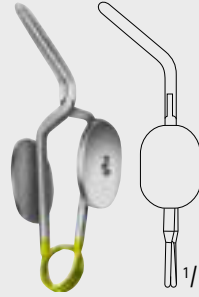

FE013K, FE023K

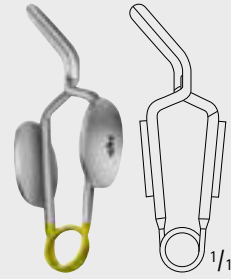

FE014K, FE024K

MÜLLER

Art. No. Art. Nr.	Jaw Maulteil	Closing force Schließkraft
FE010K	straight gerade	50 g
FE011K	curved gebogen	50 g
FE012K	curved tips Spitze gebogen	50 g
FE013K	angled to side zur Seite abgewinkelt	50 g
FE014K	angled kniegebogen	50 g
FE020K	straight gerade	80 g
FE021K	curved gebogen	80 g
FE022K	curved tips Spitze gebogen	80 g
FE023K	angled to side zur Seite abgewinkelt	80 g
FE024K	angled kniegebogen	80 g

Atraumatic vessel clips, temporary

Temporäre Gefäßclips mit atraumatischem Maulprofil



MÜLLER

FE005K

Ligature forceps  
Fadenklemme



jaw profiles, cross-serrated  
Maulprofil fein kariert

- For further vessel clips see chapter micro vascular surgery, starting on page 192
- Weitere Gefäßclips siehe Kapitel Mikro-Gefäßchirurgie, ab Seite 192



# Clips, Clamps – Clips, Klemmen

## Bulldog Clamps

## Bulldogklemmen

- Forceps for applying and removing bulldog clamps BH011R–BH031R and FB420R–FB427R
- Zange zum Anlegen und Abnehmen der Bulldogklemmen BH011R–BH031R und FB420R–FB427R



JOHNS-HOPKINS

**BH018R**

240 mm, 9 1/2"



**BH020R, BH022R**



**BH021R, BH023R**



**BH026R**



**BH027R**

### DIEFFENBACH

Art. No.	Jaw	Length of jaw serration	Length
Art. Nr.	Maulteil	Länge der Zahnung	Länge
<b>BH020R</b>	straight gerade	12 mm, 1/2"	38 mm, 1 1/2"
<b>BH021R</b>	curved gebogen	12 mm, 1/2"	38 mm, 1 1/2"
<b>BH022R</b>	straight gerade	16 mm, 5/8"	48 mm, 1 7/8"
<b>BH023R</b>	straight gerade	16 mm, 5/8"	48 mm, 1 7/8"
<b>BH026R</b>	straight gerade	16 mm, 5/8"	56 mm, 2 1/8"
<b>BH027R</b>	curved gebogen	16 mm, 5/8"	56 mm, 2 1/8"



**BH011R–BH017R**

### JOHNS-HOPKINS

Art. No.	Jaw	Length of jaw serration	Length
Art. Nr.	Maulteil	Länge der Zahnung	Länge
<b>BH011R</b>	curved gebogen	12 mm, 1/2"	38 mm, 1 1/2"
<b>BH012R</b>	curved gebogen	17 mm, 5/8"	48 mm, 1 7/8"
<b>BH013R</b>	curved gebogen	25 mm, 1"	56 mm, 2 1/8"
<b>BH014R</b>	curved gebogen	30 mm, 1 1/4"	63 mm, 2 1/2"
<b>BH015R</b>	curved gebogen	33 mm, 1 1/4"	70 mm, 2 3/4"
<b>BH016R</b>	curved gebogen	42 mm, 1 1/2"	80 mm, 3 1/8"
<b>BH017R</b>	curved gebogen	52 mm, 2"	91 mm, 3 1/2"

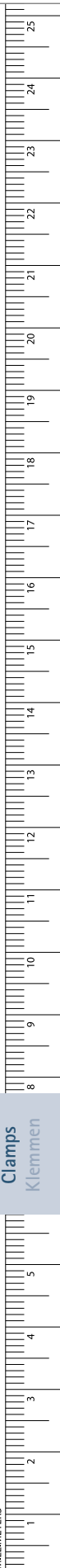

Clamps  
Klemmen

# Clips, Clamps – Clips, Klemmen

## Bulldog Clamps

### Bulldogklemmen



**BH030R**

DE BAKEY-HESS

Art. No. Art. Nr.	Jaw Maulteil	Jaw length Maullänge	Total Length Gesamtlänge
<b>BH030R</b>	angled abgewinkelt	20 mm, 3/4"	35 mm, 1 3/8"



**FB328R**

**FB329R**

**FB330R**

**FB331R**

Art. No. Art. Nr.	Jaw Maulteil	Length of jaw serration Länge der Zahnung	Total length Gesamtlänge
<b>FB328R</b>	straight gerade	14 mm, 1/2"	35 mm, 1 3/8"
<b>FB329R</b>	curved gebogen	14 mm, 1/2"	35 mm, 1 3/8"
<b>FB330R</b>	straight gerade	19 mm, 3/4"	45 mm, 1 3/4"
<b>FB331R</b>	curved gebogen	19 mm, 3/4"	45 mm, 1 3/4"



**BH031R**

DE BAKEY-HESS

Art. No. Art. Nr.	Jaw Maulteil	Jaw length Maullänge	Total length Gesamtlänge
<b>BH031R</b>	angled abgewinkelt	30 mm, 1 1/4"	40 mm, 1 1/2"

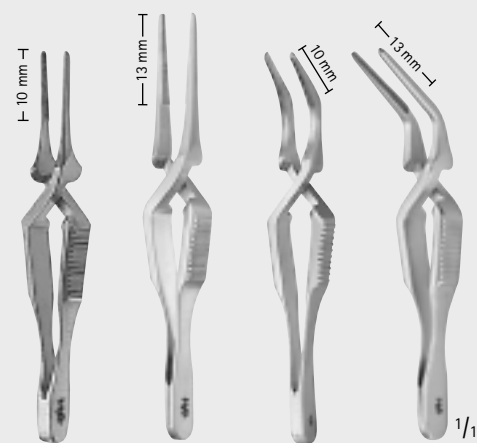

**MB741R**

**MB285R**

**BH032R**

**BH034R**

DIETRICH

Art. No. Art. Nr.	Jaw Maulteil	Jaw length Maullänge	Total length Gesamtlänge
<b>MB741R</b>	straight gerade	16 mm, 5/8"	52 mm, 2"
<b>MB285R</b>	straight gerade	20 mm, 3/4"	55 mm, 2 1/4"
<b>BH032R</b>	angled abgewinkelt	10 mm, 3/8"	48 mm, 1 7/8"
<b>BH034R</b>	angled abgewinkelt	13 mm, 1/2"	48 mm, 1 7/8"

Clamps  
Klemmen

# Clips, Clamps – Clips, Klemmen

## Bulldog Clamps

## Bulldogklemmen

- ATRAUMATA® Toothing DE BAKEY



DE BAKEY Zahnung

- Mini-bulldog clamps  
Closing force 180 g
- Mini-Bulldogklemmen  
Schließdruck 180 g



FB362R



FB363R



FB364R



FB365R



FB366R



FB367R



FB369R

1/1

Art. No. Art. Nr.	Jaw Maulteil	Length of serration Länge der Zahnung	Total length Gesamtlänge
FB362R	straight gerade	10 mm, 3/8"	50 mm, 2"
FB363R	angled, 55° gewinkelt, 55°	10 mm, 3/8"	45 mm, 1 3/4"
FB364R	straight gerade	14 mm, 1/2"	55 mm, 2 1/4"
FB365R	angled, 55° gewinkelt, 55°	14 mm, 1/2"	50 mm, 2"
FB366R	straight gerade	20 mm, 3/4"	60 mm, 2 3/8"
FB367R	angled, 55° gewinkelt, 55°	20 mm, 3/4"	55 mm, 2 1/4"
FB369R	curved gebogen	20 mm, 3/4"	55 mm, 2 1/4"

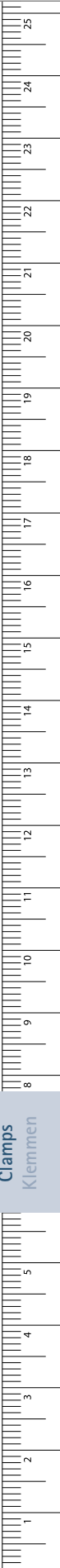

Clamps  
Klemmen

# Clips, Clamps – Clips, Klemmen

## Bulldog Clamps

### Bulldogklemmen

■ ATRAUMATA® Toothing DE BAKEY



DE BAKEY Zahnung



DE BAKEY

Art. No. Art. Nr.	Jaw Maulteil	Length of serration Länge der Zahnung	Total length Gesamtlänge
<b>FB420R</b>	straight gerade	20 mm, 3/4"	80 mm, 3 1/8"
<b>FB422R</b>	straight gerade	30 mm, 1 1/4"	90 mm, 3 1/2"
<b>FB424R</b>	straight gerade	45 mm, 1 3/4"	105 mm, 4 1/8"
<b>FB426R</b>	straight gerade	65 mm, 2 1/2"	125 mm, 5"



DE BAKEY

Art. No. Art. Nr.	Jaw Maulteil	Length of serration Länge der Zahnung	Total length Gesamtlänge
<b>FB421R</b>	curved gebogen	20 mm, 3/4"	80 mm, 3 1/8"
<b>FB423R</b>	curved gebogen	30 mm, 1 1/4"	85 mm, 3 1/4"
<b>FB425R</b>	curved gebogen	45 mm, 1 3/4"	95 mm, 3 3/4"
<b>FB427R</b>	curved gebogen	65 mm, 2 1/2"	115 mm, 4 1/2"



GLOVER

Art. No. Art. Nr.	Jaw Maulteil	Length of serration Länge der Zahnung	Total length Gesamtlänge
<b>FB432R</b>	straight gerade	25 mm, 1"	70 mm, 2 3/4"
<b>FB434R</b>	straight gerade	40 mm, 1 1/2"	95 mm, 3 3/4"
<b>FB436R</b>	straight gerade	60 mm, 2 3/8"	115 mm, 4 1/2"



GLOVER

Art. No. Art. Nr.	Jaw Maulteil	Length of serration Länge der Zahnung	Total length Gesamtlänge
<b>FB433R</b>	curved gebogen	25 mm, 1"	65 mm, 2 1/2"
<b>FB435R</b>	curved gebogen	40 mm, 1 1/2"	90 mm, 3 1/2"
<b>FB437R</b>	curved gebogen	60 mm, 2 3/8"	110 mm, 4 1/4"

Clamps  
Klemmen

INCHES

# Clips, Clamps – Clips, Klemmen

## Bulldog Clamps

## Bulldogklemmen

■ ATRAUMATA® Toothing DE BAKEY



DE BAKEY Zahnung



FB382R

FB383R

GREGORY

Art. No. Art. Nr.	Jaw Maulteil	Length of jaw serration Länge der Zahnung	Total length Gesamtlänge
FB382R	angled abgewinkelt	50 mm, 2"	105 mm, 4 1/8"
FB383R	angled abgewinkelt	65 mm, 2 1/2"	120 mm, 4 3/4"

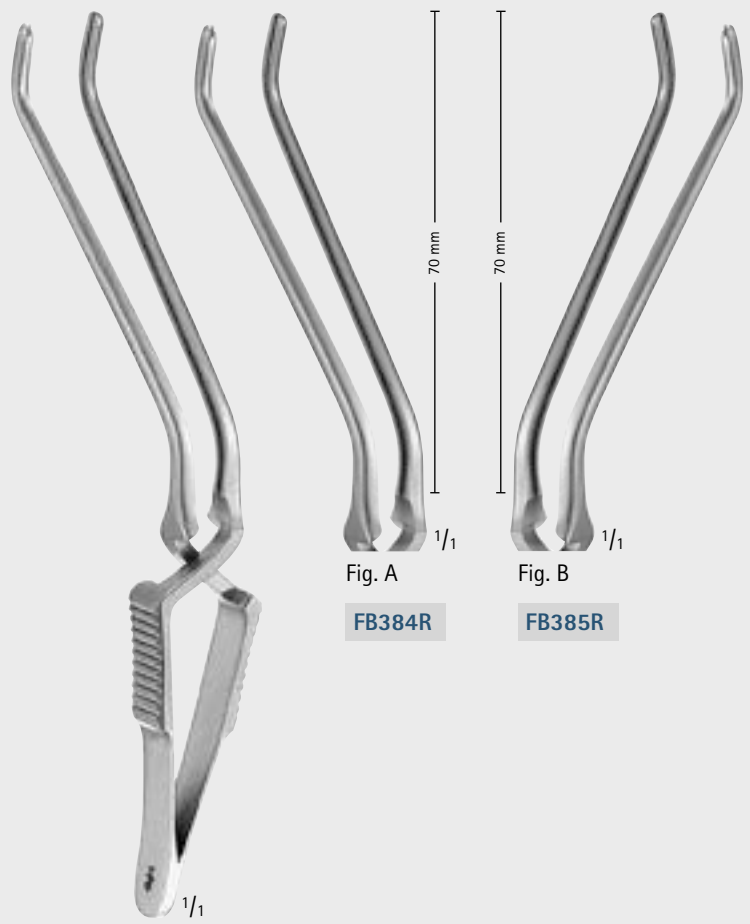

Fig. A

FB384R

Fig. B

FB385R

FB384R-FB385R

GREGORY

Art. No. Art. Nr.	Jaw Maulteil	Length of jaw serration Länge der Zahnung	Total length Gesamtlänge
FB384R	left curved links gebogen	70 mm, 2 3/4"	120 mm, 4 3/4"
FB385R	right curved rechts gebogen	70 mm, 2 3/4"	120 mm, 4 3/4"

Clamps  
Klemmen

MILLIMETERS

# Clips, Clamps – Clips, Klemmen

## Atraumatic Clamps

## Atraumatische Klemmen

■ ATRAUMATA® Toothing DE BAKEY



DE BAKEY Zahnung



DERRA

FB559R-FB561R



FB559R

170 mm  
6 3/4"



FB560R

170 mm  
6 3/4"

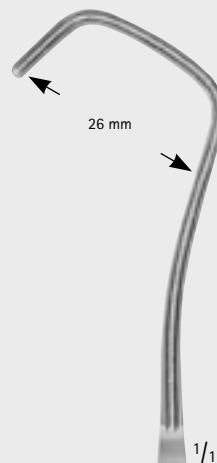

FB561R

175 mm  
6 7/8"

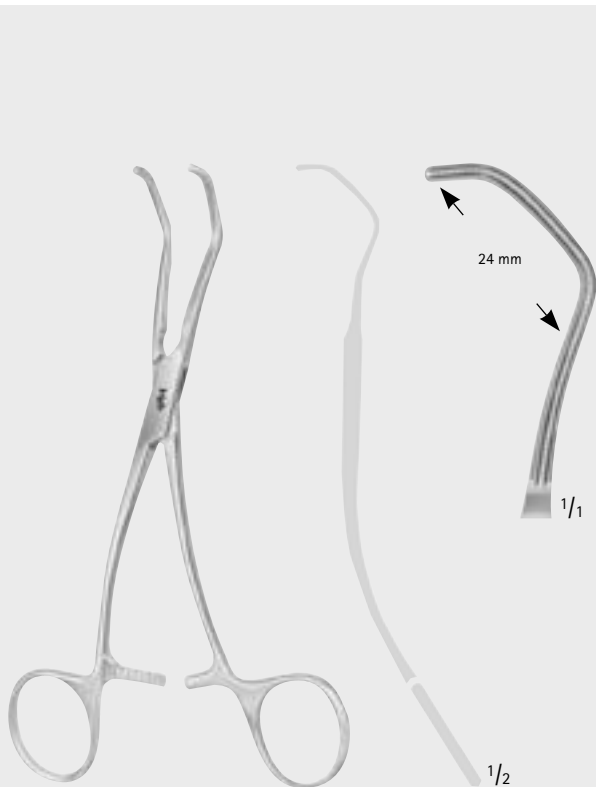

COOLEY

FB563R

160 mm, 6 1/4"

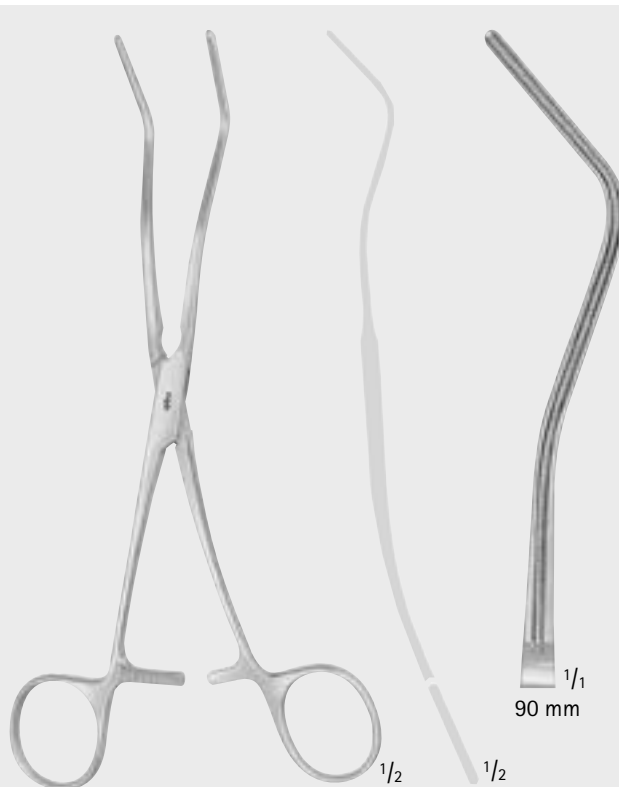
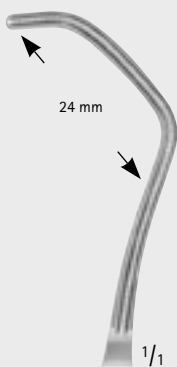

COOLEY

FB570R

200 mm, 7 7/8"

90 mm



Clamps  
Klemmen

# Clips, Clamps – Clips, Klemmen

## Dissecting and Ligature Clamps

### Präparier-, Ligaturklemmen

■ ATRAUMATA® Toothing DE BAKEY



DE BAKEY Zahnung



DE BAKEY

**FB484R**

190 mm, 7 1/2"



DE BAKEY

**FB498R**

210 mm, 8 1/4"

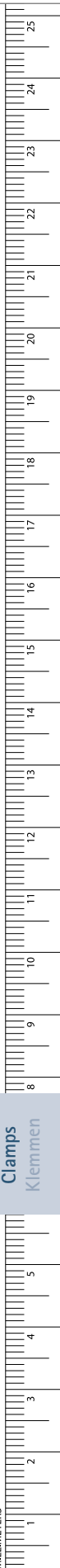

# Clips, Clamps – Clips, Klemmen

## Atraumatic Clamps

### Atraumatische Klemmen

■ ATRAUMATA® Toothing DE BAKEY



DE BAKEY Zahnung

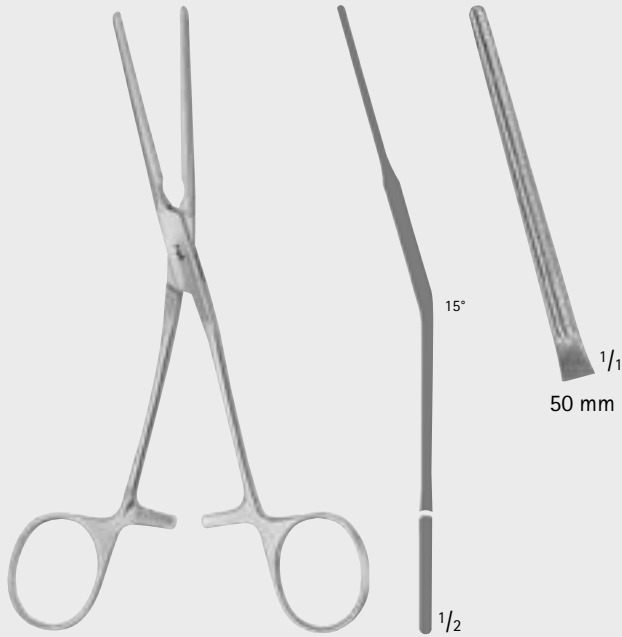

DE BAKEY  
**FB553R**  
165 mm, 6 1/2"

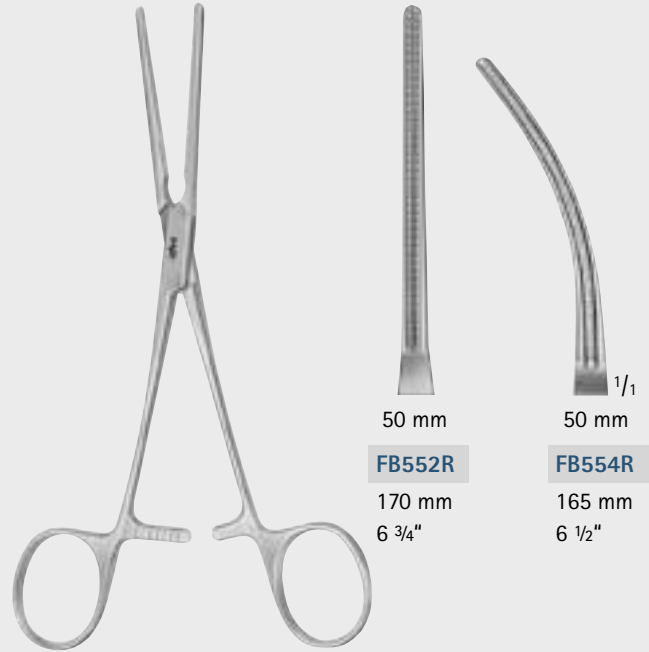

DE BAKEY  
**FB552R-FB554R**

**FB552R**  
170 mm  
6 3/4"  
**FB554R**  
165 mm  
6 1/2"



DE BAKEY  
**FB452R**  
205 mm, 8"



**FB453R**  
200 mm  
7 7/8"  
**FB455R**  
225 mm  
8 7/8"

DE BAKEY  
**FB453R-FB455R**

Clamps  
Klemmen

INCHES



# Clips, Clamps – Clips, Klemmen

## Atraumatic Clamps

### Atraumatische Klemmen

■ ATRAUMATA® Toothing DE BAKEY



DE BAKEY Zahnung

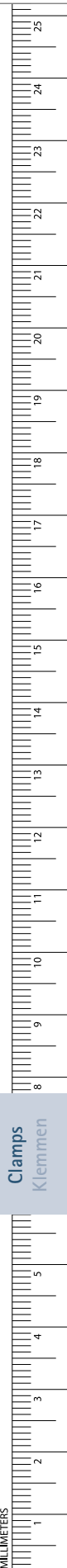
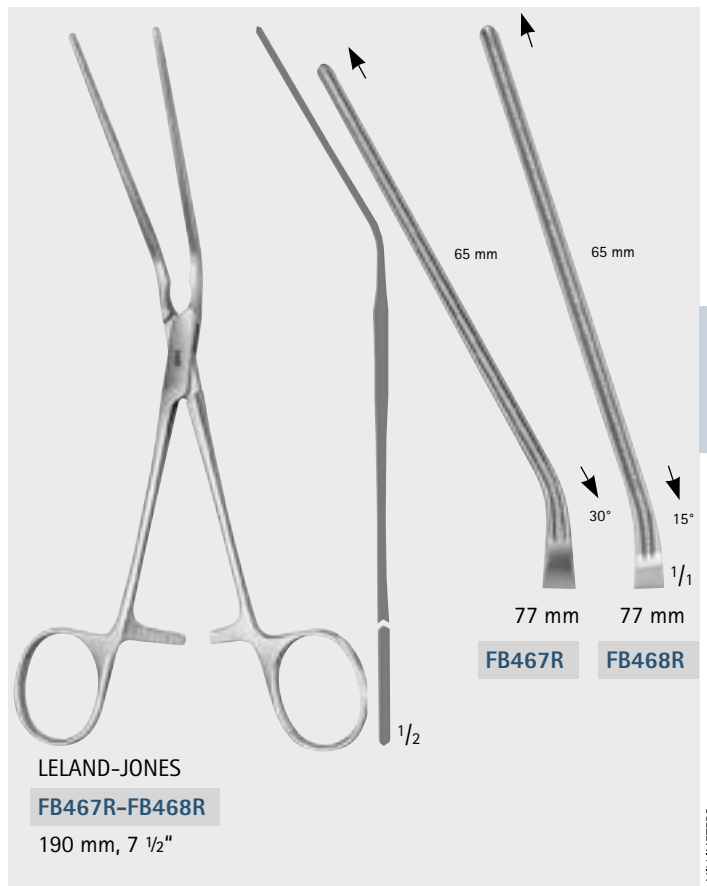
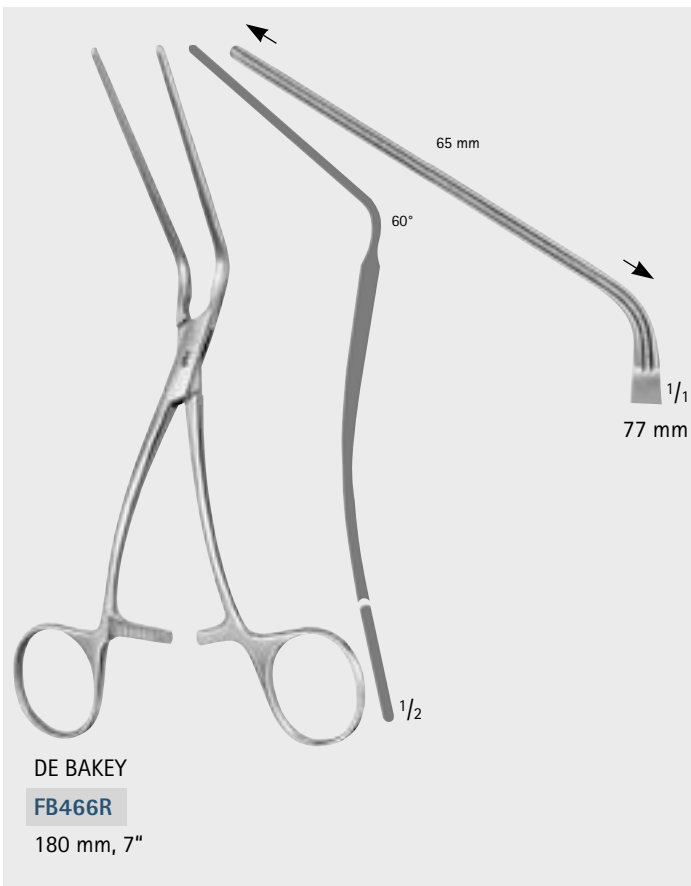
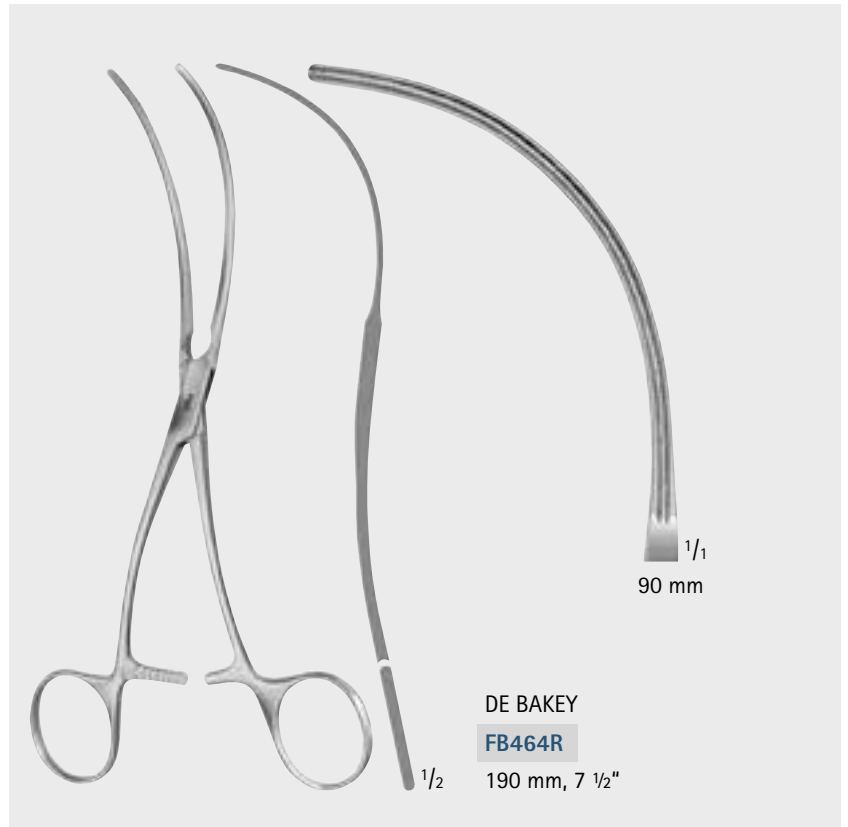
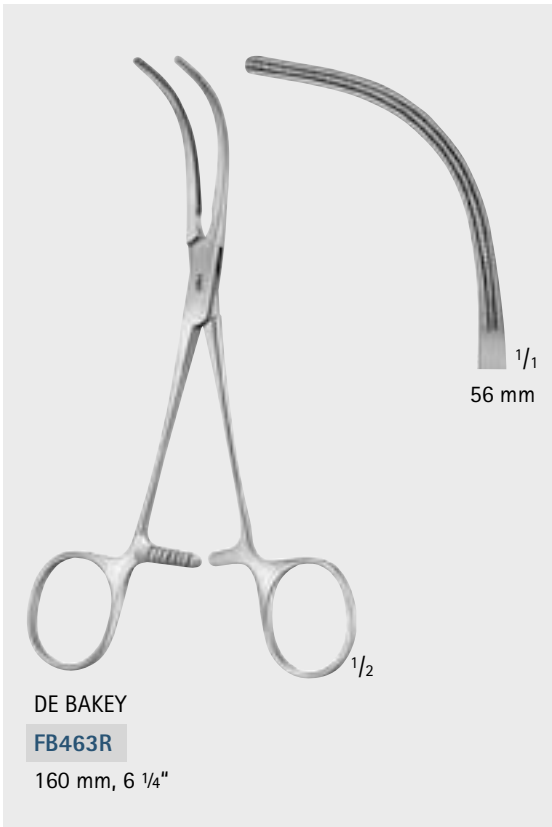

# Clips, Clamps – Clips, Klemmen

## Atraumatic Clamps

### Atraumatische Klemmen

■ ATRAUMATA® Toothing DE BAKEY



DE BAKEY Zahnung

■ Titanium  
■ Titan

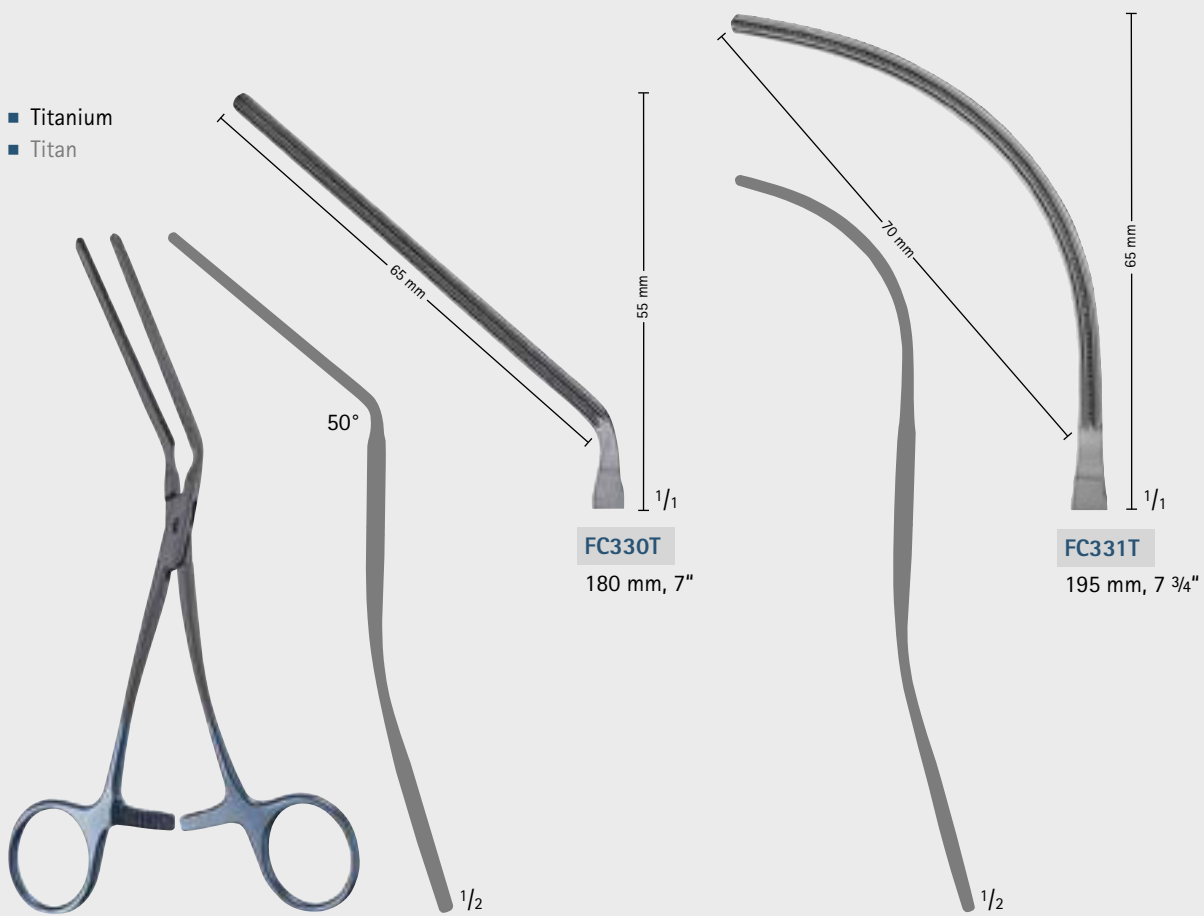

DE BAKEY

FC330T-FC331T

- Please find further atraumatic clamps in our main catalog for cardiovascular and thoracic surgery C05321.
- Weitere Atraumatische Klemmen, siehe Hauptkatalog Kardiovaskular C05321.

# Clips, Clamps – Clips, Klemmen

## Atraumatic Clamps

### Atraumatische Klemmen

■ ATRAUMATA® Toothing DE BAKEY



DE BAKEY Zahnung



**FC337T**

110 mm  
4 1/4"



**FC338T**

110 mm  
4 1/4"

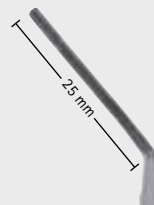

**FC339T**

110 mm  
4 1/4"

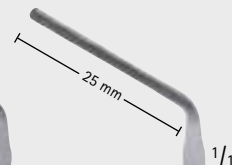

**FC340T**

110 mm  
4 1/4"

■ Titanium  
■ Titan



DE BAKEY

**FC337T-FC343T**



**FC341T**

95 mm  
3 3/4"



**FC342T**

100 mm  
4"



**FC343T**

100 mm  
4"

Clamps  
Klemmen

MILLIMETERS

# Clips, Clamps – Clips, Klemmen

## Delicate Hemostatic Forceps

### Feine Arterienklemmen



CARREL

**BH100R**

85 mm, 3 1/4"



BABY-MOSQUITO (HARTMANN)

**BH104R–BH115R**

100 mm, 4"

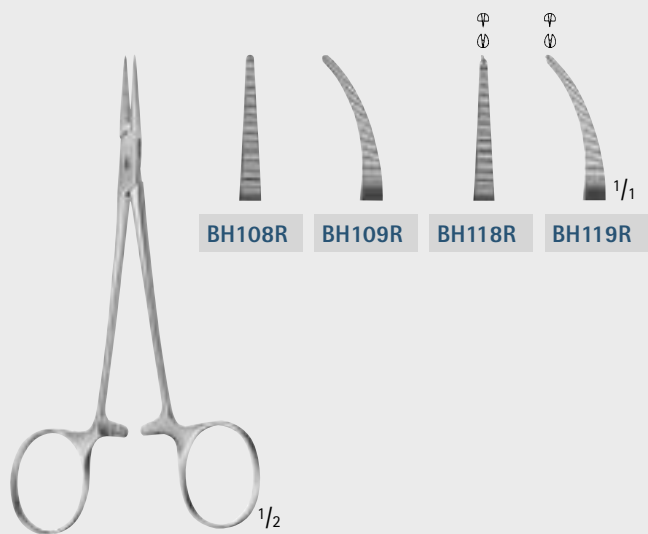

MICRO-HALSTED

**BH108R–BH119R**

125 mm, 5"

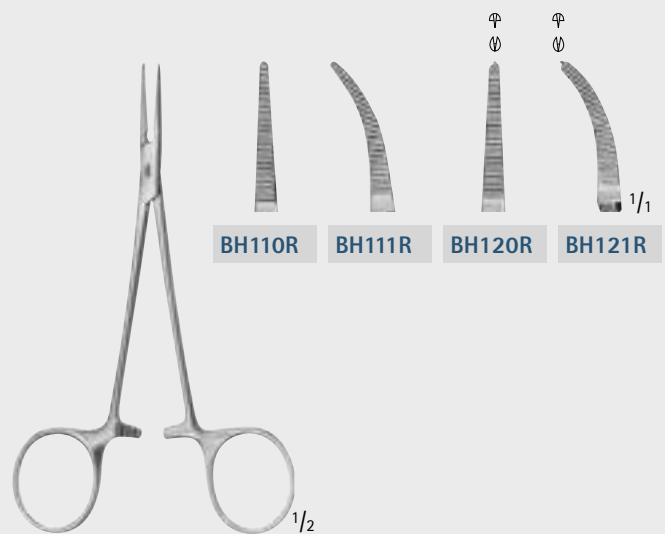

HALSTED-MOSQUITO

**BH110R–BH121R**

125 mm, 5"

Clamps  
Klemmen

INCHES

# Clips, Clamps – Clips, Klemmen

## Delicate Hemostatic Forceps

### Feine Arterienklemmen

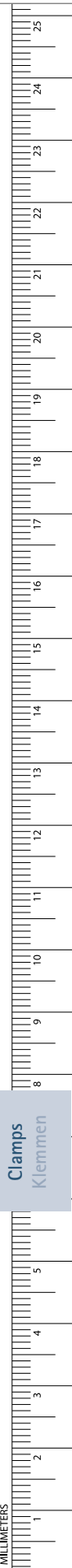
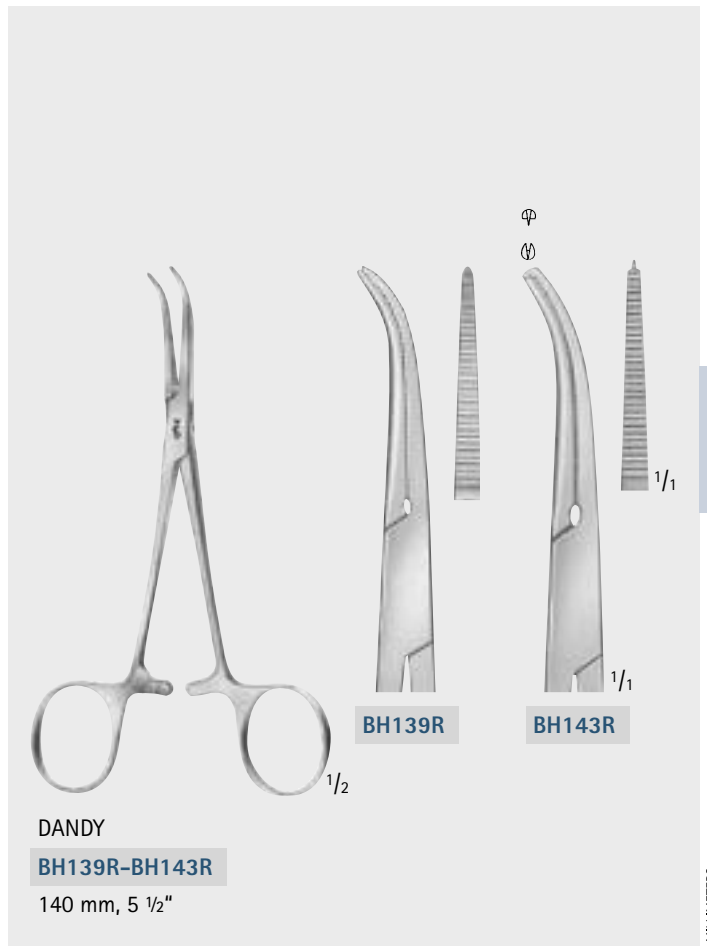
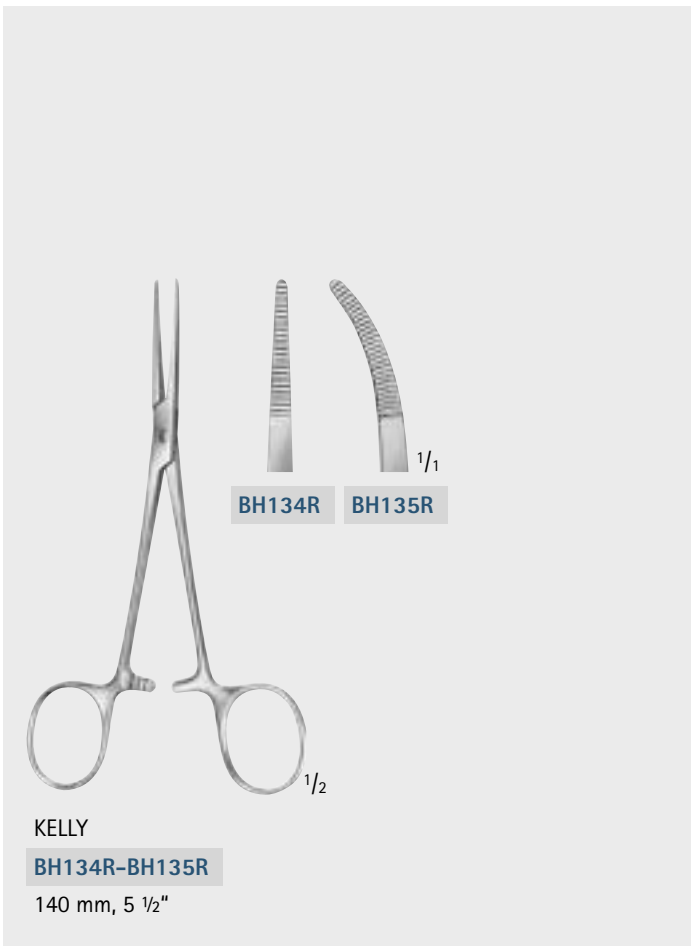
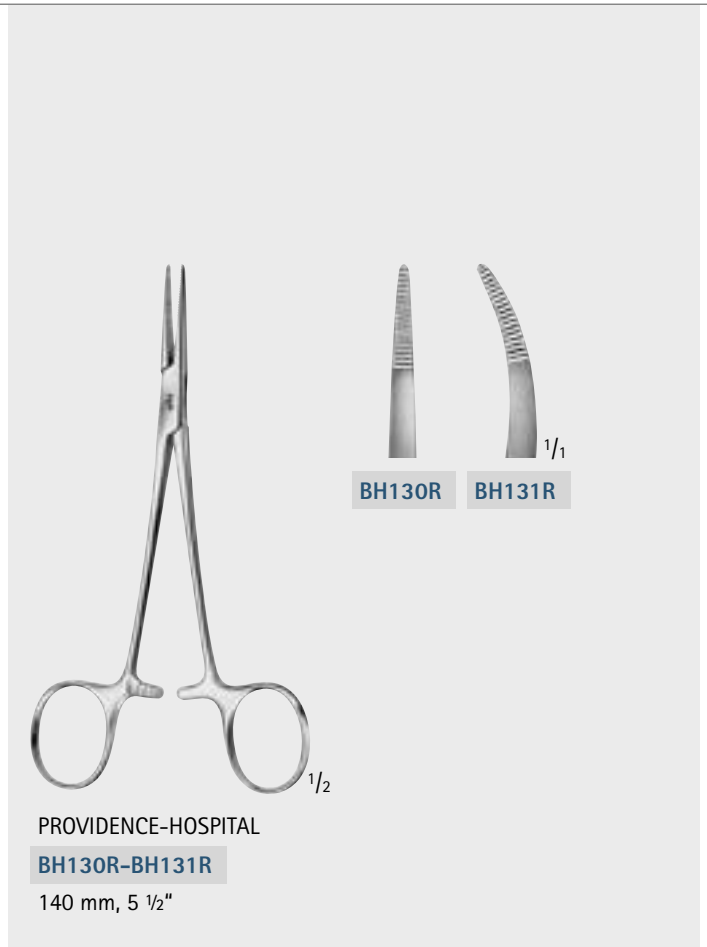
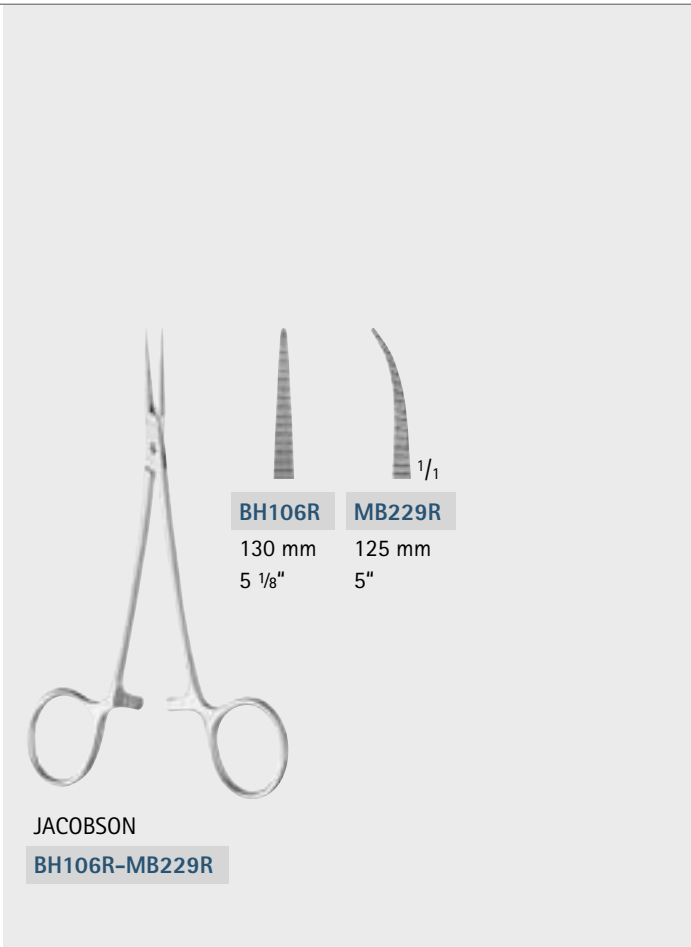

# Clips, Clamps – Clips, Klemmen

## Delicate Hemostatic Forceps

### Feine Arterienklemmen

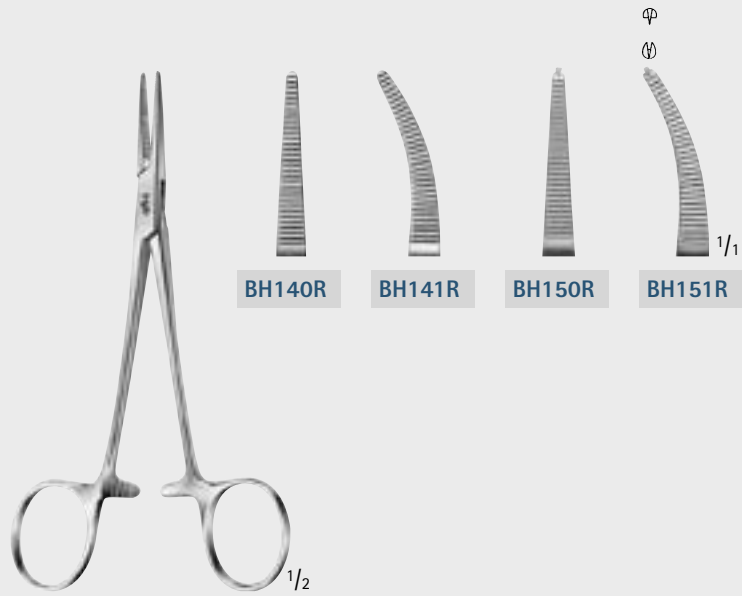

BH140R

BH141R

BH150R

BH151R

BABY-CRILE

BH140R-BH151R

140 mm, 5 1/2"

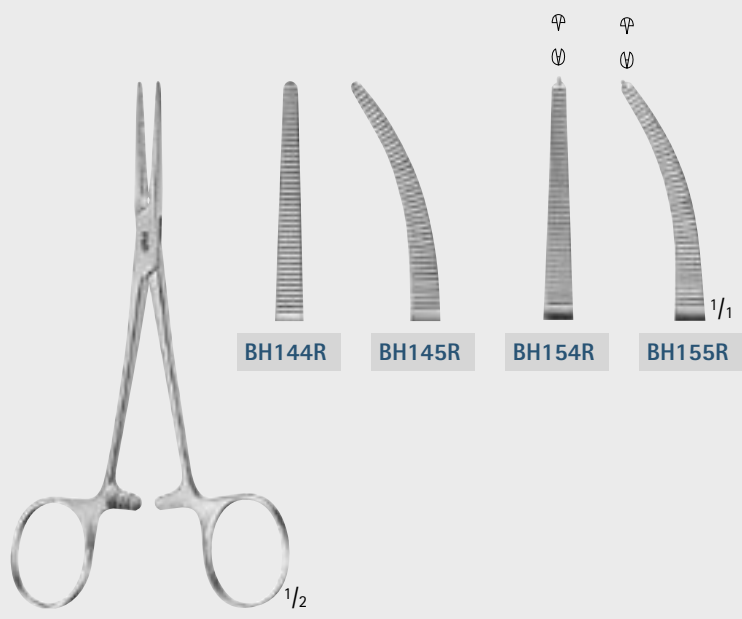

BH144R

BH145R

BH154R

BH155R

CRILE

BH144R-BH155R

140 mm, 5 1/2"



DUNHILL

BH123R

125 mm, 5"

Clamps  
Klemmen

# Clips, Clamps – Clips, Klemmen

## Hemostatic Forceps

### Arterienklemmen

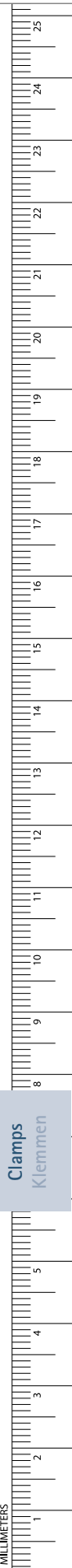
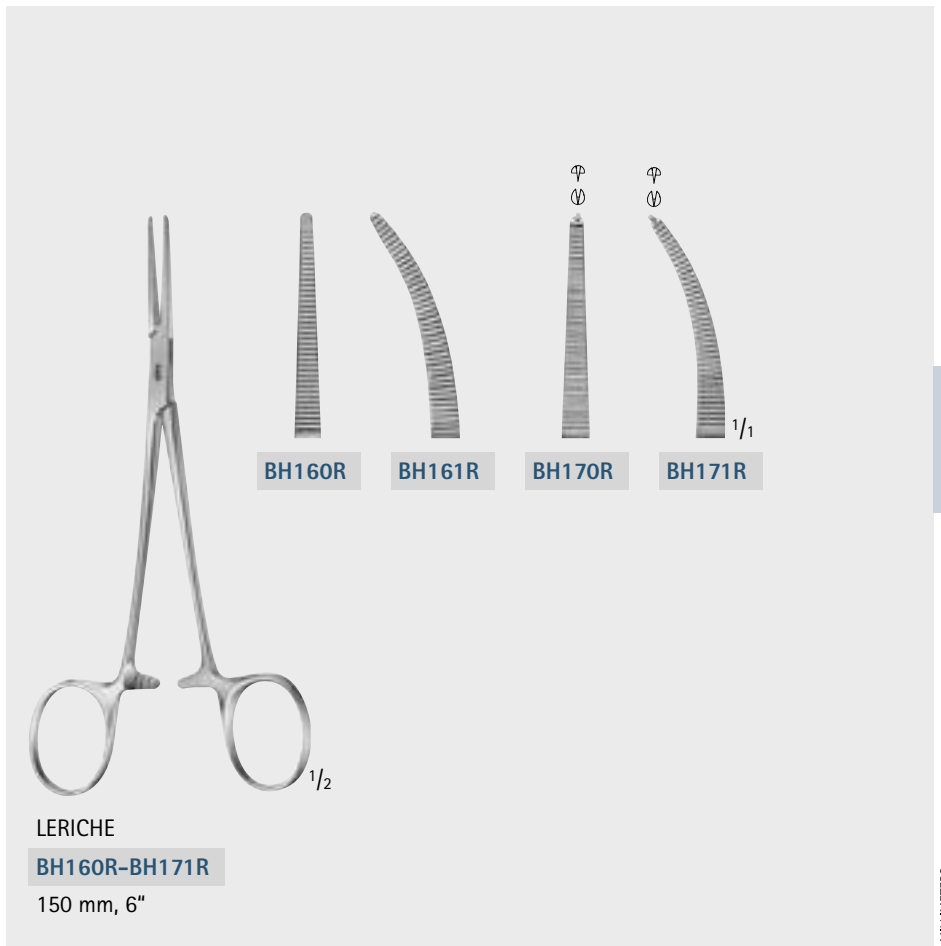
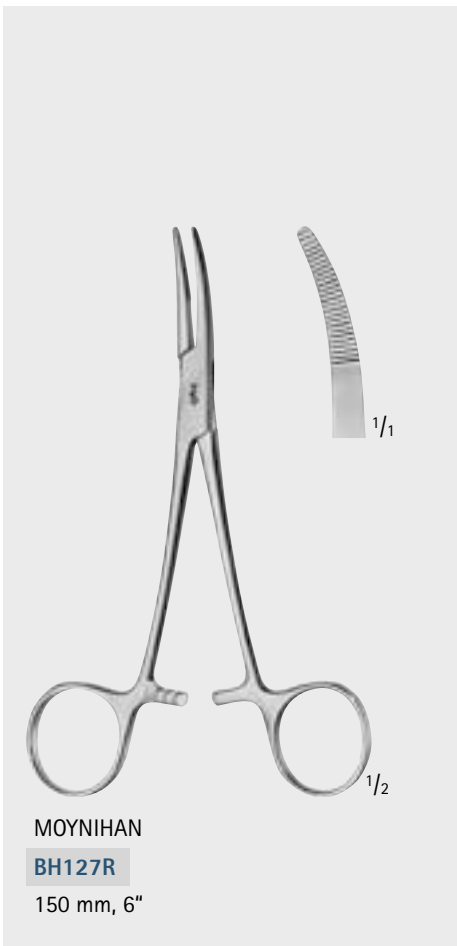
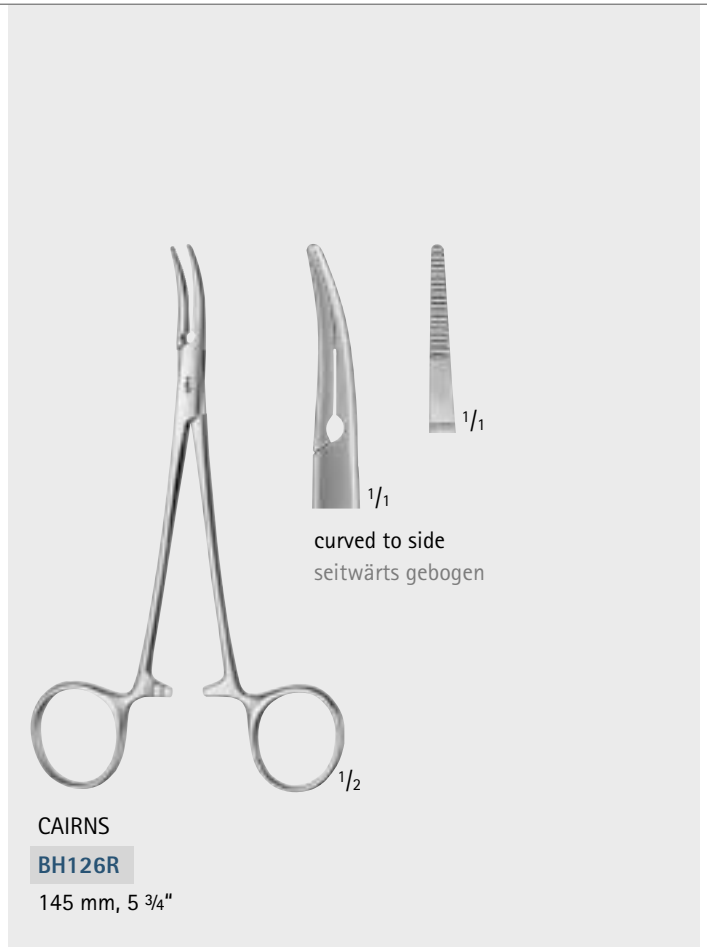
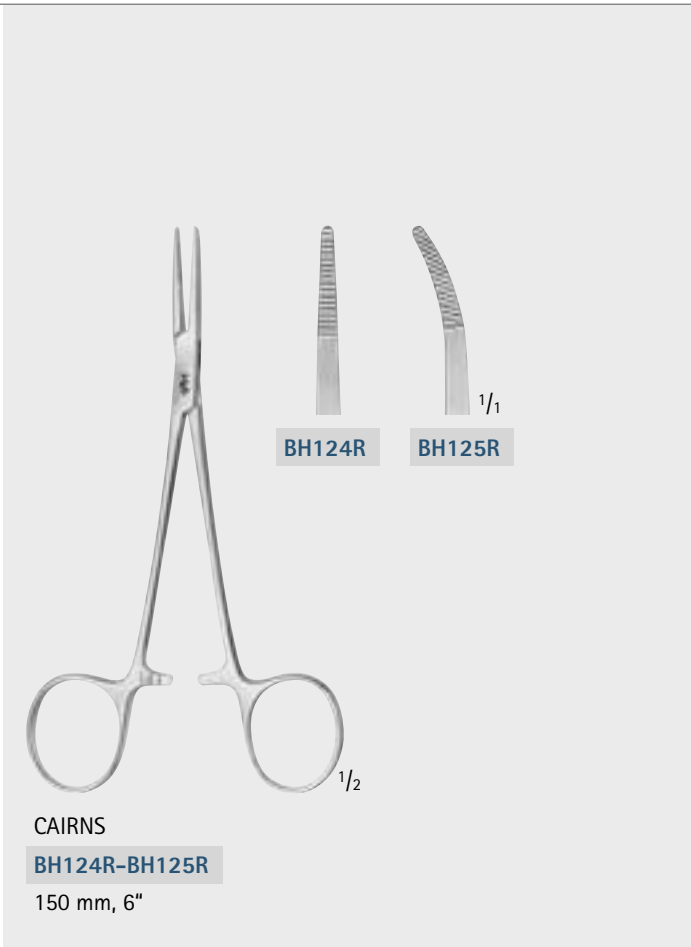

# Clips, Clamps – Clips, Klemmen

## Delicate Hemostatic Forceps

### Feine Arterienklemmen



COLLER

MD464-MD469

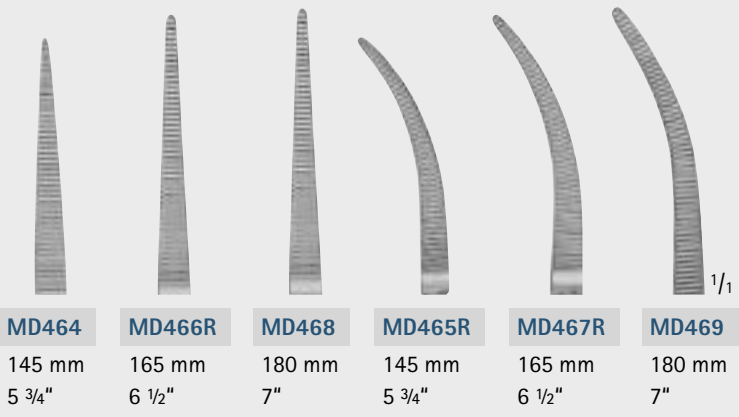

RANKIN

BH164R-BH165R

160 mm, 6 1/4"

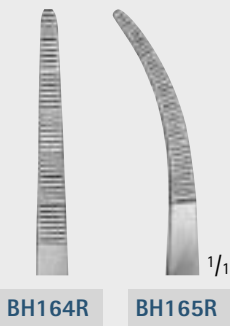

CRILE

BH166R-BH177R

160 mm, 6 1/4"

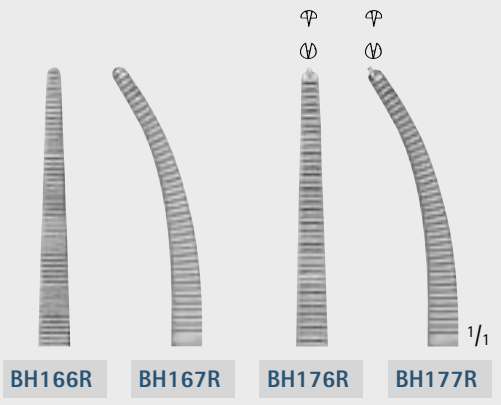



# Clips, Clamps – Clips, Klemmen

## Delicate Hemostatic Forceps

### Feine Arterienklemmen

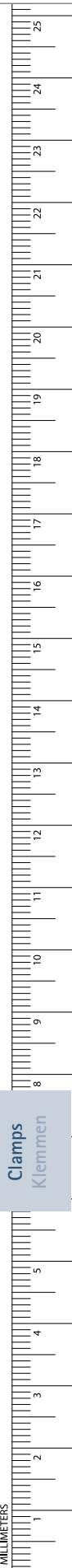
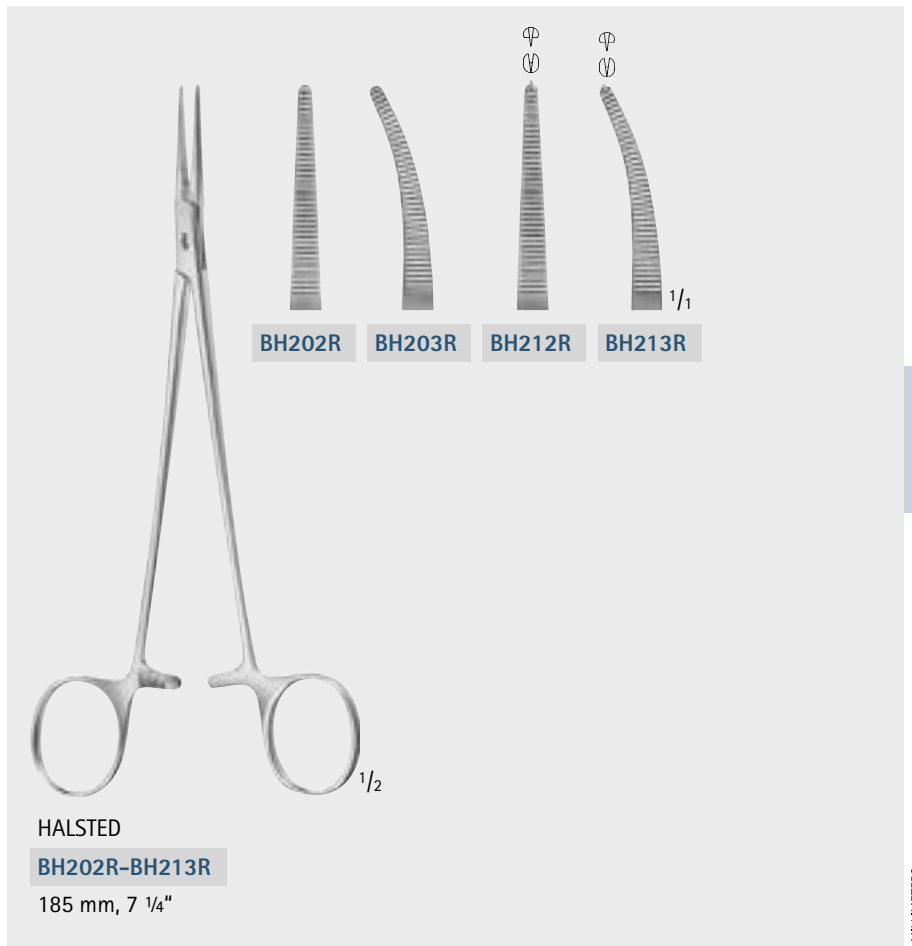
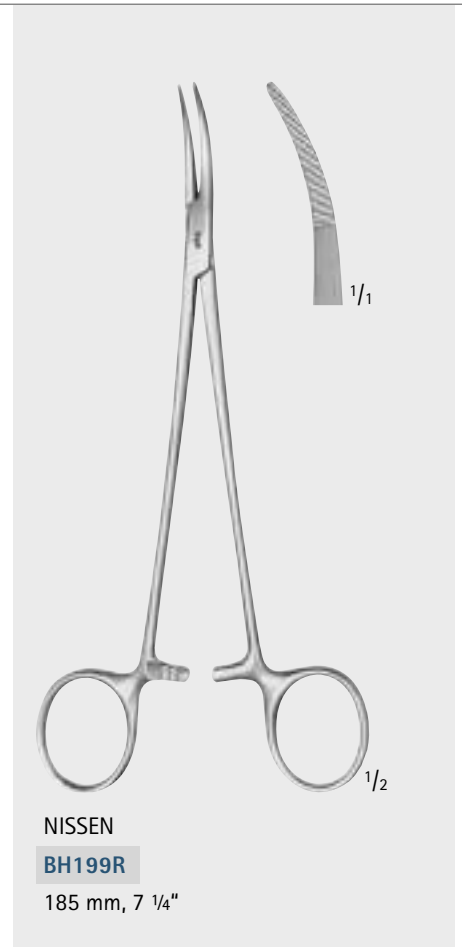

# Clips, Clamps – Clips, Klemmen

## Delicate Hemostatic Forceps

### Feine Arterienklemmen



**HALSTED-MOSQUITO**  
**BH210R–BH215R**  
200 mm, 7 7/8"

**BH210R** **BH211R** **BH214R** **BH215R**

**JACOBSON**  
**BH187R**  
190 mm, 7 1/2"

**ADSON**  
**BH205R**  
215 mm, 8 1/2"

**FRASER-KELLY (CRILE)**  
**BH183R**  
180 mm, 7"

Clamps  
Klemmen

# Clips, Clamps – Clips, Klemmen

## Delicate Hemostatic Forceps

### Feine Arterienklemmen

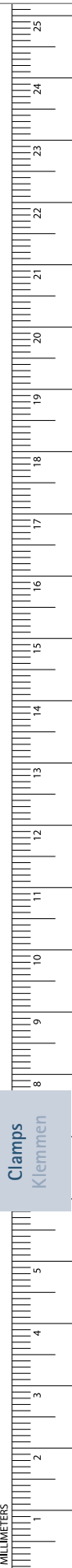
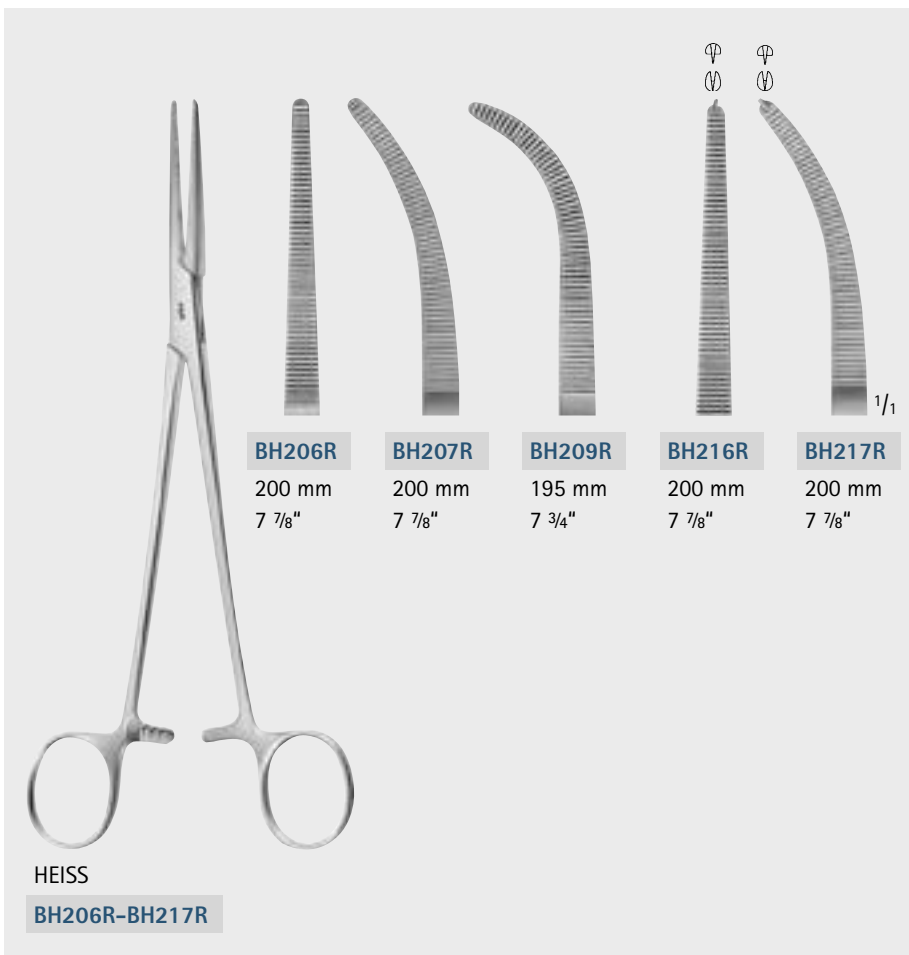
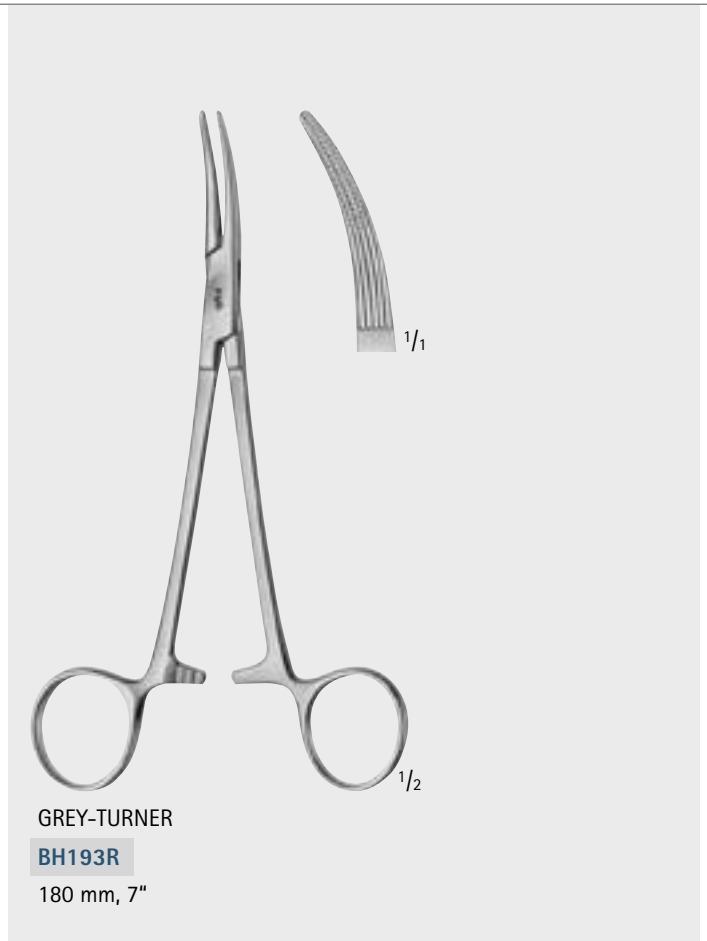
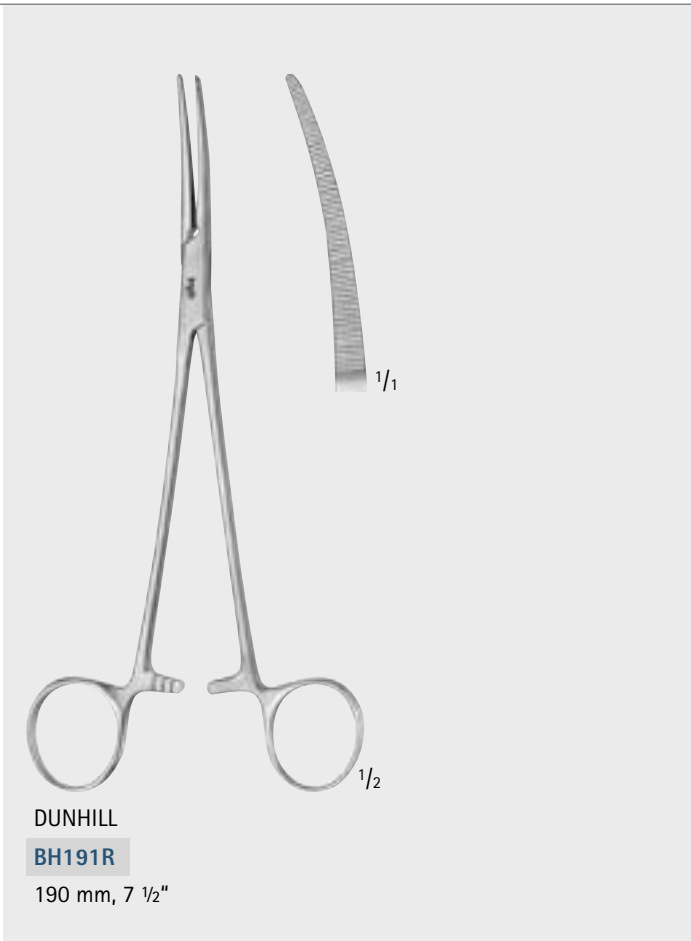

# Clips, Clamps – Clips, Klemmen

## Hemostatic Forceps

### Arterienklemmen

PEAN  
BH412R-BH415R

<b>BH412R</b>	<b>BH414R</b>	<b>BH413R</b>	<b>BH415R</b>
130 mm	140 mm	130 mm	140 mm
5 1/8"	5 1/2"	5 1/8"	5 1/2"



PEAN  
BH422R-BH425R

<b>BH422R</b>	<b>BH424R</b>	<b>BH425R</b>
130 mm	140 mm	140 mm
5 1/8"	5 1/2"	5 1/2"

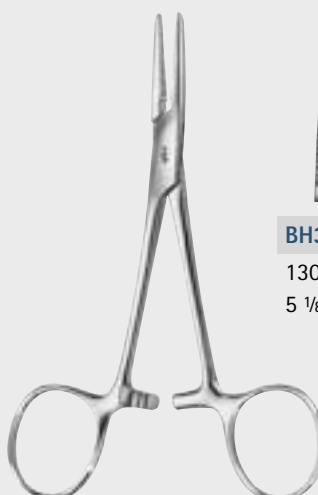

SPENCER-WELLS  
BH332R-BH361R

<b>BH332R</b>	<b>BH334R</b>	<b>BH336R</b>	<b>BH338R</b>	<b>BH333R</b>	<b>BH335R</b>	<b>BH337R</b>	<b>BH339R</b>	<b>BH361R</b>
130 mm	150 mm	175 mm	200 mm	130 mm	150 mm	175 mm	200 mm	230 mm
5 1/8"	6"	6 7/8"	7 7/8"	5 1/8"	6"	6 7/8"	7 7/8"	9"

Clamps  
Klemmen

INCHES

# Clips, Clamps – Clips, Klemmen

## Hemostatic Forceps

### Arterienklemmen

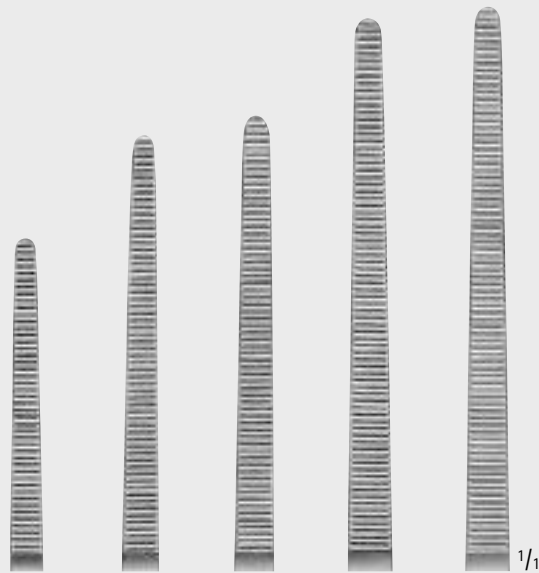

<b>BH442R</b>	<b>BH444R</b>	<b>BH446R</b>	<b>BH448R</b>	<b>BH450R</b>
160 mm	185 mm	200 mm	225 mm	240 mm
6 1/4"	7 1/4"	7 7/8"	8 7/8"	9 1/2"



<b>BH443R</b>	<b>BH445R</b>	<b>BH447R</b>	<b>BH449R</b>	<b>BH451R</b>
160 mm	185 mm	200 mm	225 mm	240 mm
6 1/4"	7 1/4"	7 7/8"	8 7/8"	9 1/2"

ROCHESTER-PEAN

**BH442R-BH451R**

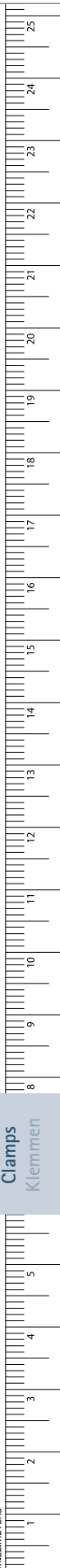

# Clips, Clamps – Clips, Klemmen

## Hemostatic Forceps

### Arterienklemmen



KOCHER

**BH610R**

strong pattern  
kräftiges Modell  
145 mm, 5 3/4"

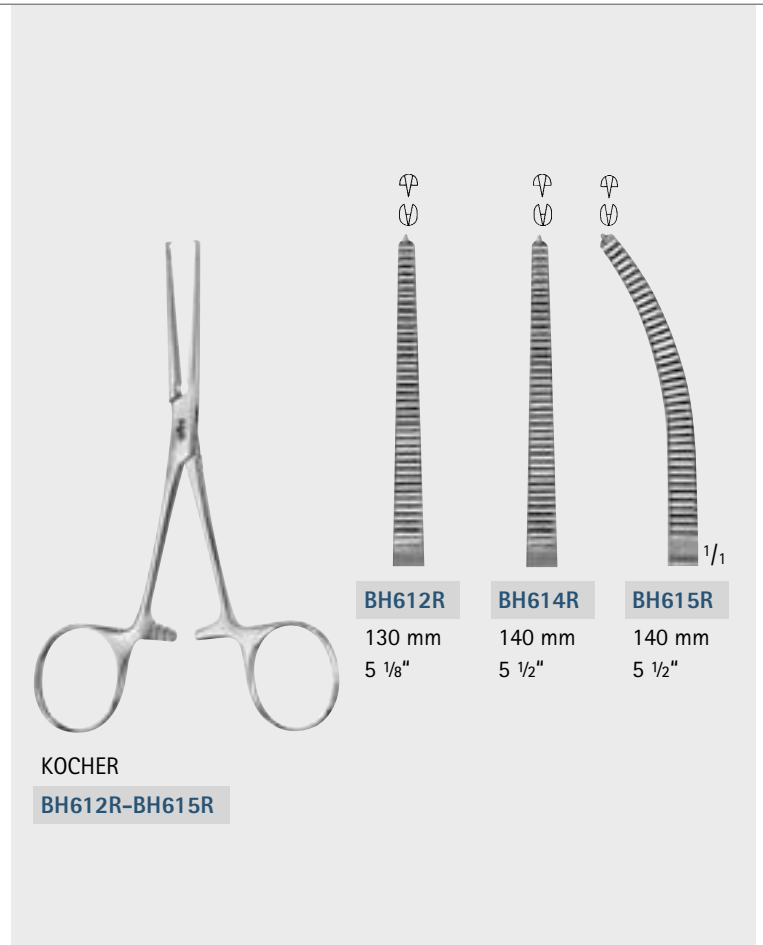

KOCHER

**BH612R-BH615R**

**BH612R**

130 mm  
5 1/8"

**BH614R**

140 mm  
5 1/2"

**BH615R**

140 mm  
5 1/2"

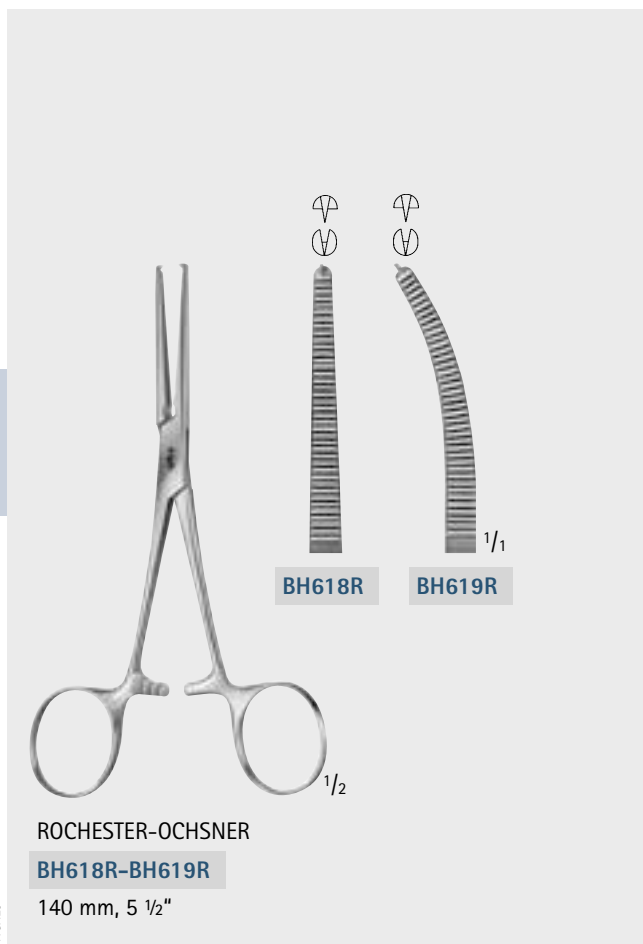

ROCHESTER-OCHSNER

**BH618R-BH619R**

140 mm, 5 1/2"

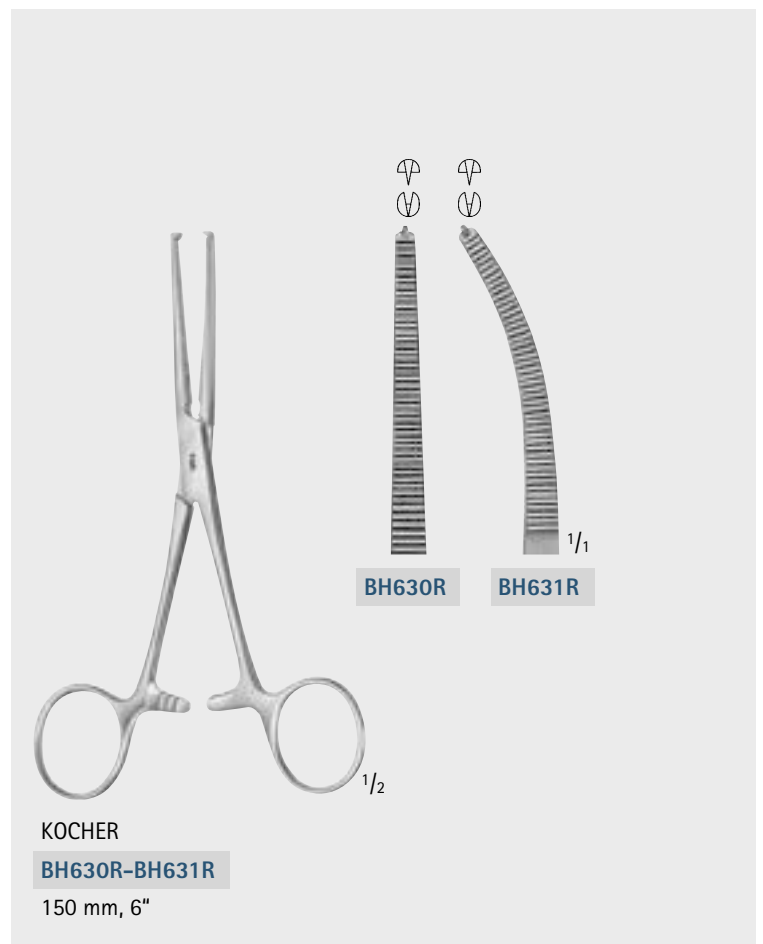

KOCHER

**BH630R-BH631R**

150 mm, 6"

# Clips, Clamps – Clips, Klemmen

## Hemostatic Forceps

### Arterienklemmen

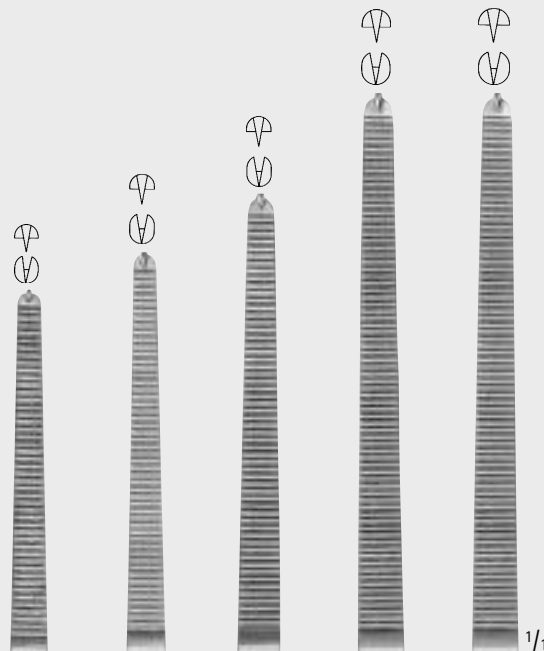

<b>BH642R</b>	<b>BH644R</b>	<b>BH646R</b>	<b>BH648R</b>	<b>BH650R</b>
160 mm	185 mm	200 mm	225 mm	240 mm
6 1/4"	7 1/4"	7 7/8"	8 7/8"	9 1/2"

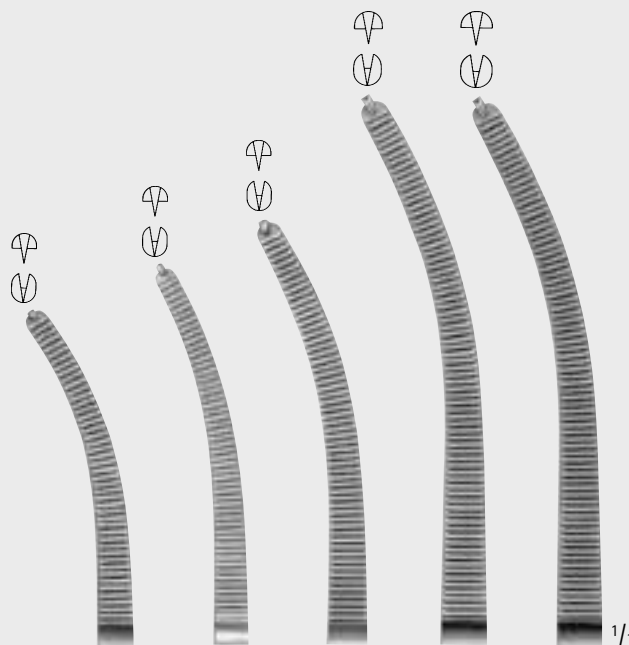

<b>BH643R</b>	<b>BH645R</b>	<b>BH647R</b>	<b>BH649R</b>	<b>BH651R</b>
160 mm	185 mm	200 mm	225 mm	240 mm
6 1/4"	7 1/4"	7 7/8"	8 7/8"	9 1/2"



**KOCHER-OCHSNER**  
**BH642R-BH651R**

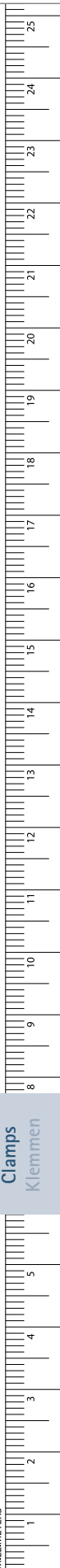

# Clips, Clamps – Clips, Klemmen

## Hemostatic Forceps, Special Patterns

### Arterienklemmen, Spezial-Modelle

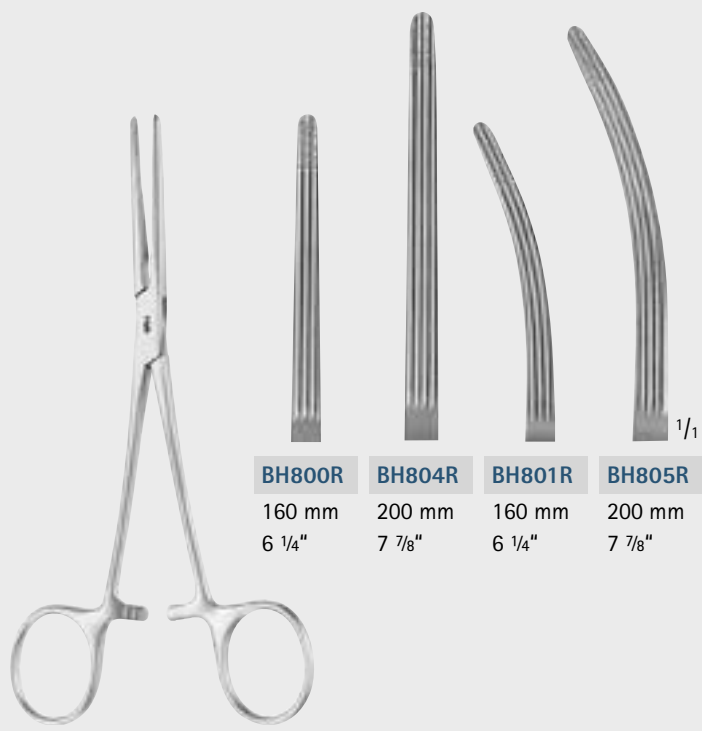
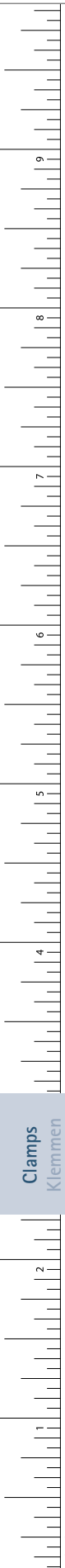

BH800R	BH804R	BH801R	BH805R
160 mm	200 mm	160 mm	200 mm
6 1/4"	7 7/8"	6 1/4"	7 7/8"

ROCHESTER-CARMALT

BH800R-BH805R



BH807R	BH808R

FICKLING

BH807R-BH808R

180 mm, 7"

Clamps  
Klemmen



# Clips, Clamps – Clips, Klemmen

## Hemostatic Forceps, Tonsil Forceps

### Arterienklemmen, Tonsillenklemmen

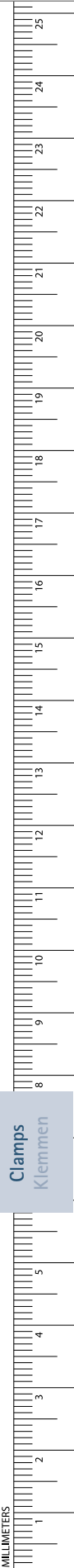
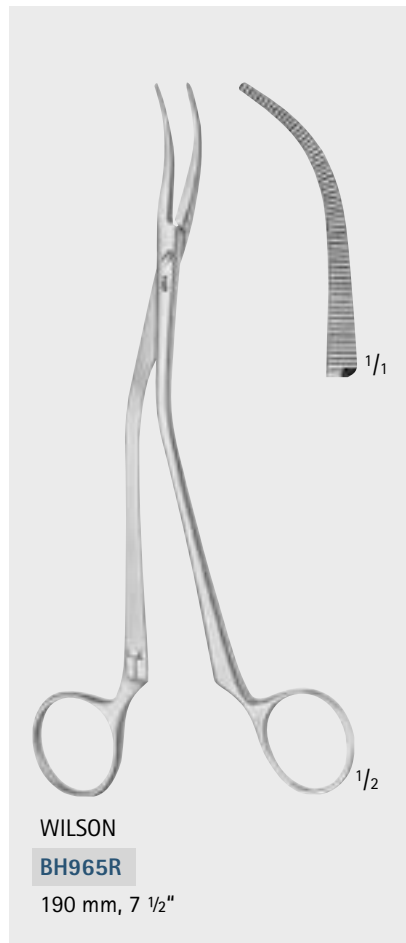
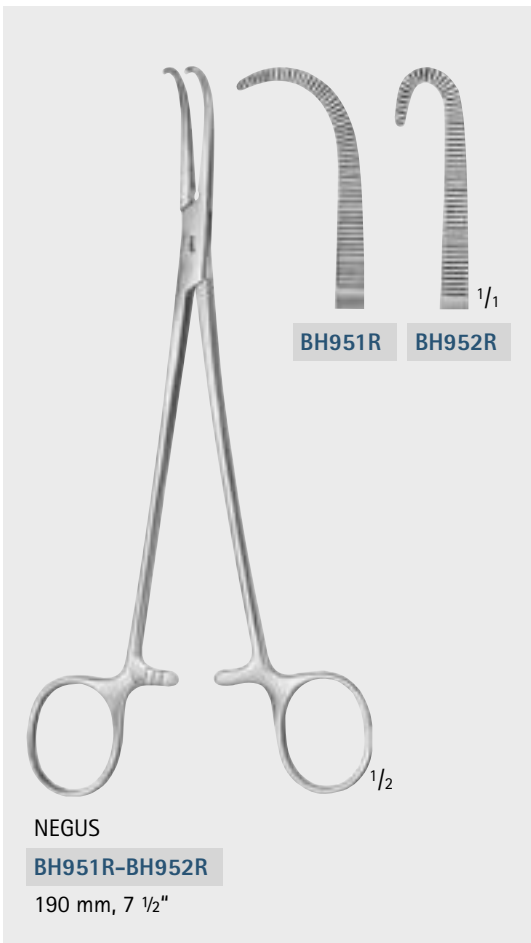
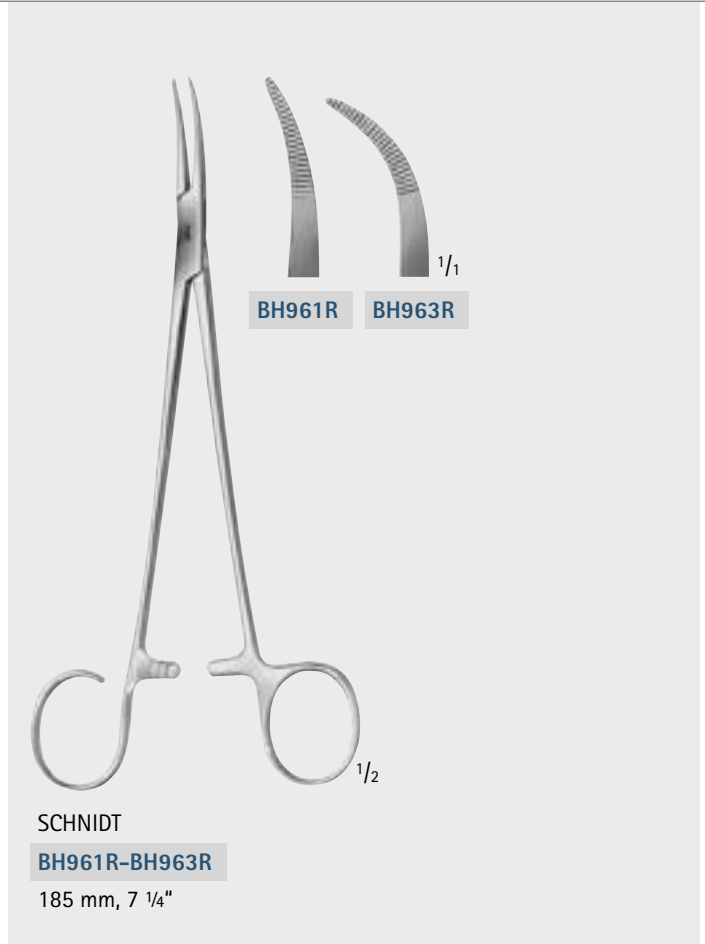
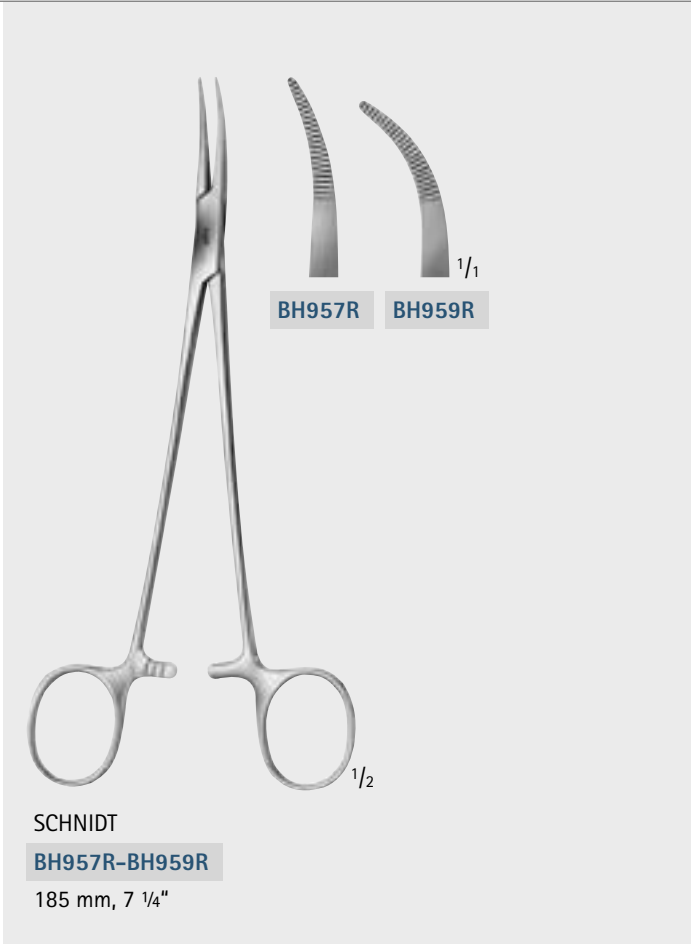

Clamps  
Klemmen

# Clips, Clamps – Clips, Klemmen

## Dissecting and Ligature Forceps

### Präparier- und Ligaturklemmen

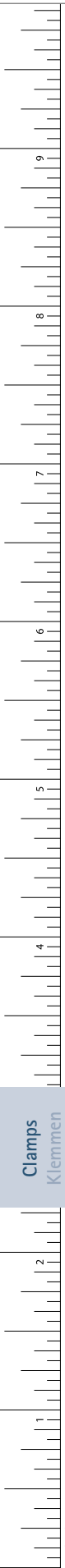

1/1  
smooth jaw  
glattes Maul

**BJ002R**  
95 mm, 3 3/4"



1/1

**MICRO-ADSON**  
**BJ008R**  
140 mm, 5 1/2"



1/1

**BABY-OVERHOLT**  
**BJ009R**  
135 mm, 5 1/4"



1/1

**BJ011R**  
140 mm  
5 1/2"

**BJ012R**  
180 mm  
7"

**BABY-MIXTER**  
**BJ011R-BJ012R**



1/1

**BJ097R**  
slightly curved  
leicht gebogen

**BJ098R**  
strong curved  
stark gebogen

**BJ097R-BJ098R**  
without ratchet  
ohne Sperre  
140 mm, 5 1/2"

# Clips, Clamps – Clips, Klemmen

## Dissecting and Ligature Forceps

### Präparier- und Ligaturklemmen



**BJ013R** **BJ014R**  
 140 mm 180 mm  
 5 1/2" 7"

**BABY-ADSON**  
**BJ013R-BJ014R**



**MD569** **MD570R**  
 140 mm 180 mm  
 5 1/2" 7"

**MD569-MD570R**

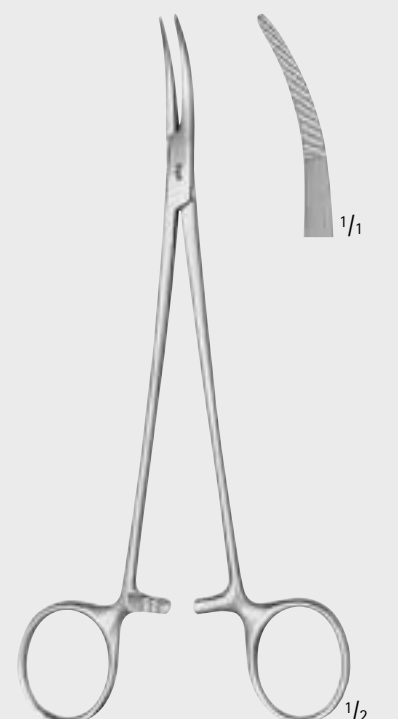

**NISSEN**  
**BH199R**  
 185 mm, 7 1/4"

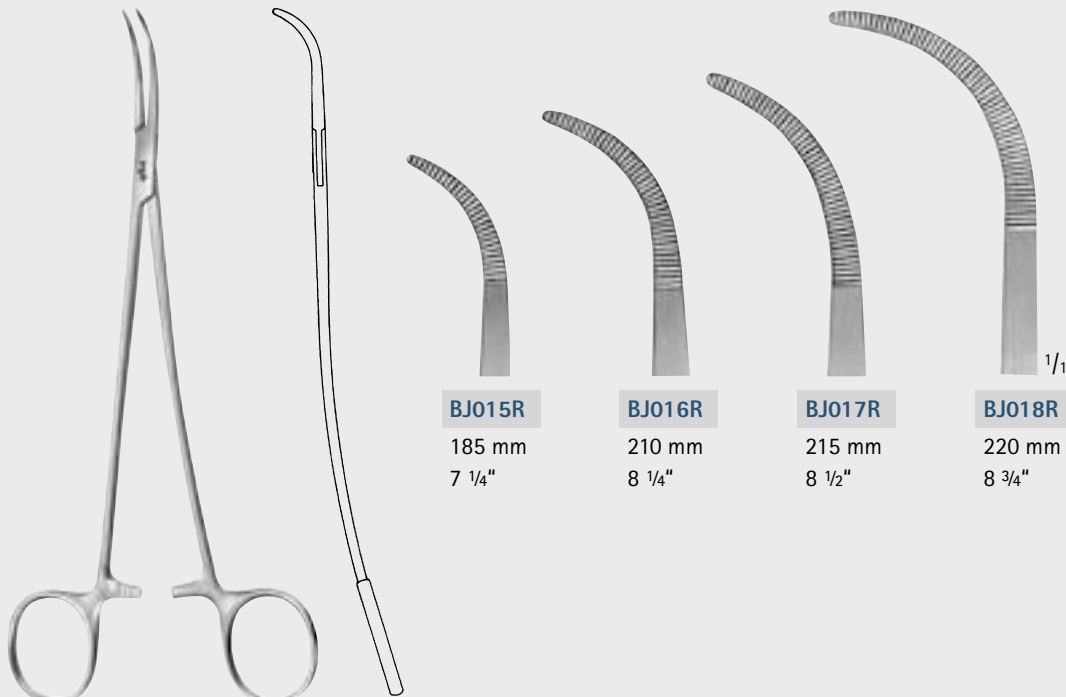

**BJ015R** **BJ016R** **BJ017R** **BJ018R**  
 185 mm 210 mm 215 mm 220 mm  
 7 1/4" 8 1/4" 8 1/2" 8 3/4"

**BJ015R-BJ018R**  
 S-shaped, delicate  
 S-förmig gebogen, grazil

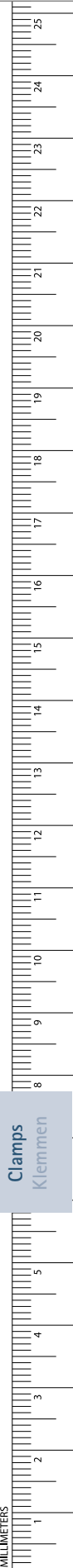

Clamps  
Klemmen

# Clips, Clamps – Clips, Klemmen

## Dissecting and Ligature Forceps

### Präparier- und Ligaturklemmen



**OVERHOLT-MIXTER**  
**BJ019R**  
 205 mm, 8"

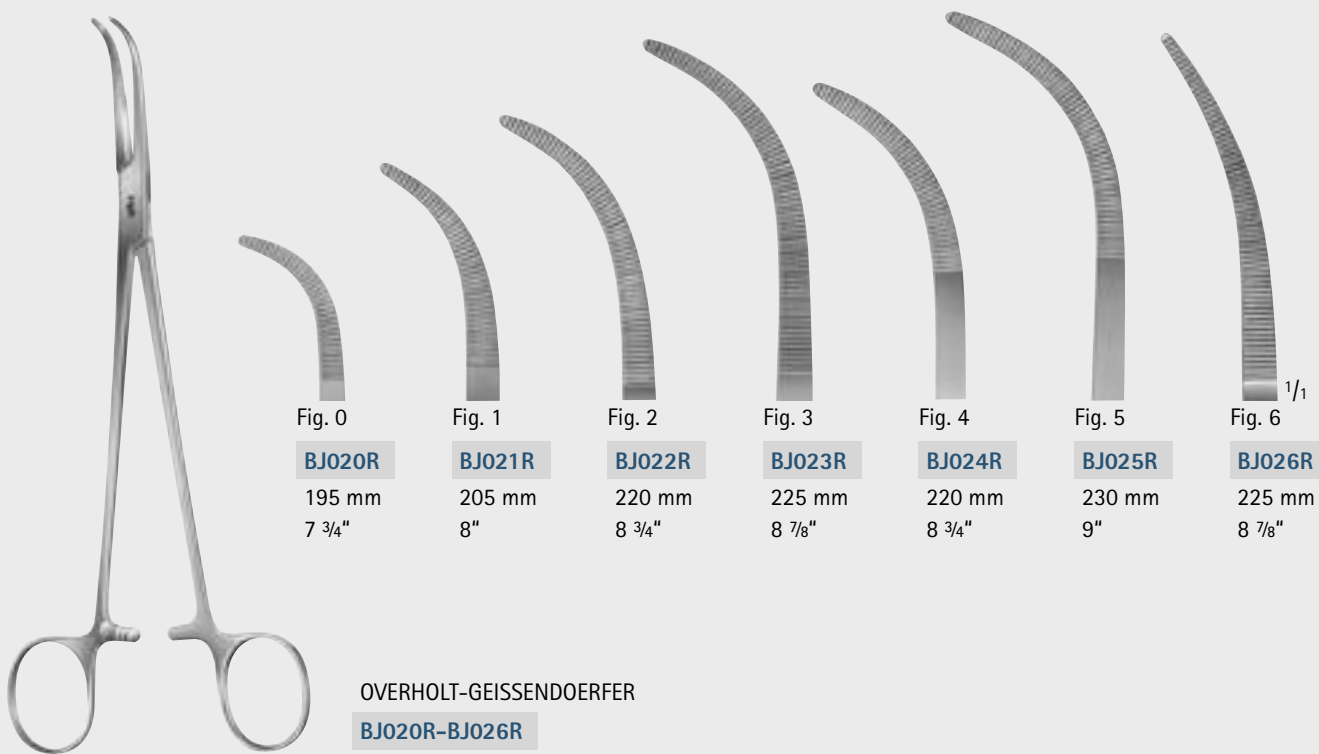

Fig. 0	Fig. 1	Fig. 2	Fig. 3	Fig. 4	Fig. 5	Fig. 6
<b>BJ020R</b>	<b>BJ021R</b>	<b>BJ022R</b>	<b>BJ023R</b>	<b>BJ024R</b>	<b>BJ025R</b>	<b>BJ026R</b>
195 mm	205 mm	220 mm	225 mm	220 mm	230 mm	225 mm
7 3/4"	8"	8 3/4"	8 7/8"	8 3/4"	9"	8 7/8"

**OVERHOLT-GEISSENDOERFER**  
**BJ020R-BJ026R**

Clamps  
Klemmen

# Clips, Clamps – Clips, Klemmen

## Dissecting and Ligature Forceps

### Präparier- und Ligaturklemmen

**OVERHOLT**  
**BJ080R–BJ086R**  
 delicate pattern  
 feine Ausführung

Fig.	Model	Length (mm)	Length (inches)
Fig. 0	BJ080R	215 mm	8 1/2"
Fig. 1	BJ081R	210 mm	8 1/4"
Fig. 2	BJ082R	220 mm	8 3/4"
Fig. 3	BJ083R	225 mm	8 7/8"
Fig. 6	BJ086R	225 mm	8 7/8"

**GEMINI**  
**BJ100R–BJ103R**

Model	Length (mm)	Length (inches)
BJ100R	140 mm	5 1/2"
BJ102R	180 mm	7"
BJ103R	200 mm	7 7/8"

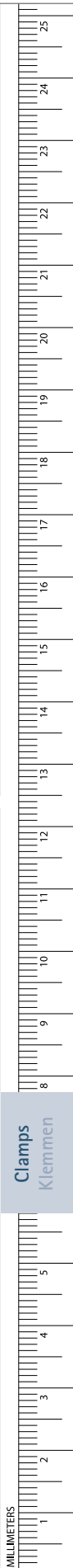

# Clips, Clamps – Clips, Klemmen

## Dissecting and Ligature Forceps

### Präparier- und Ligaturklemmen

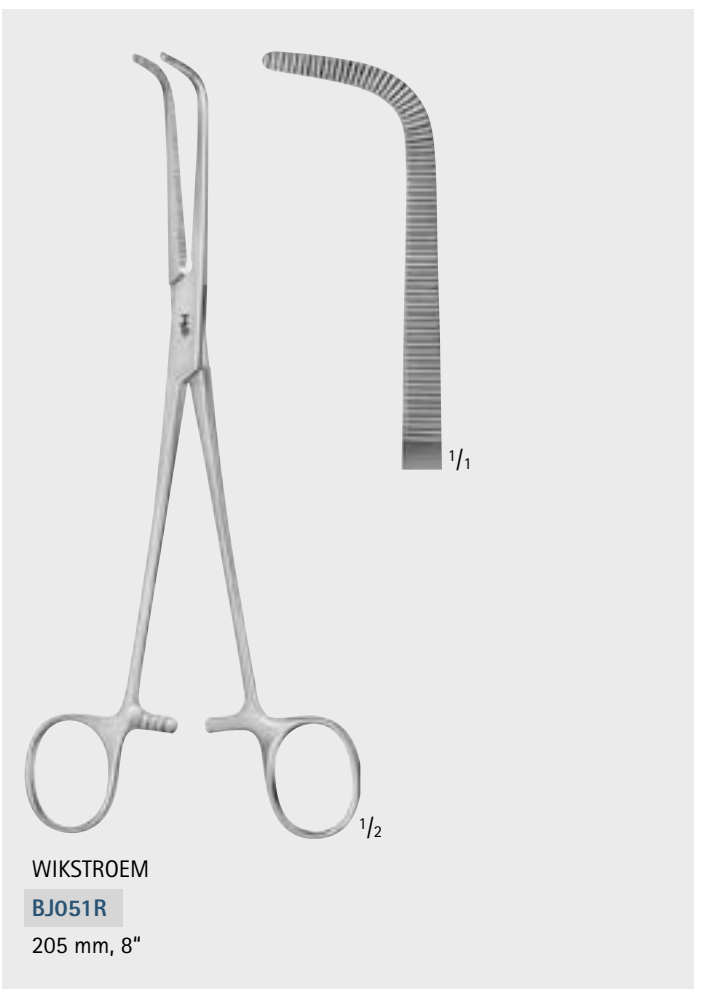
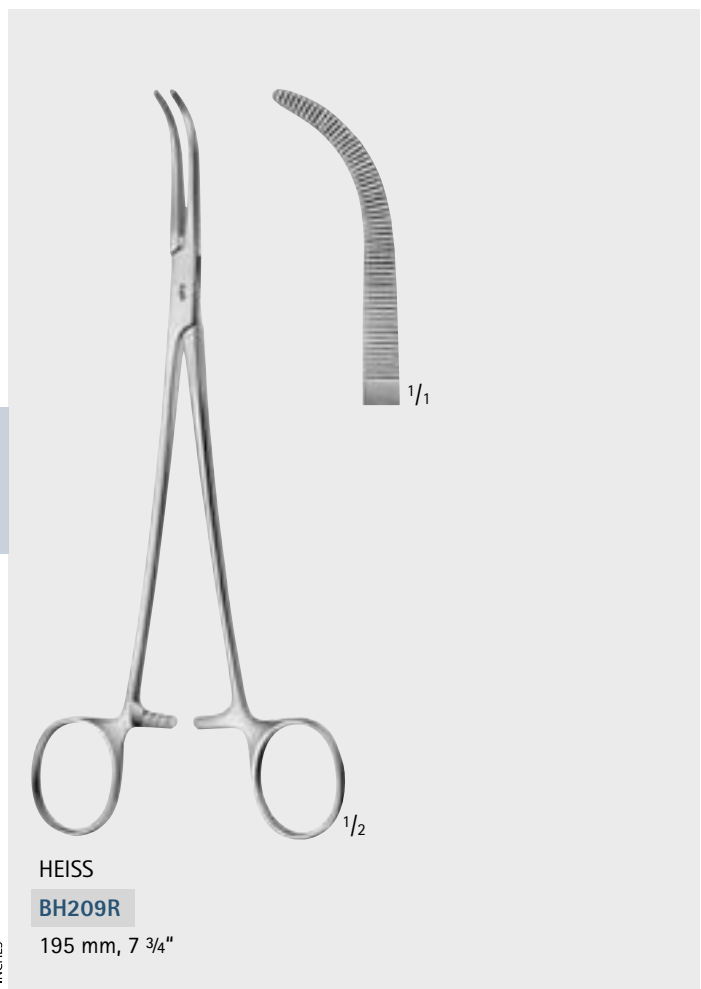
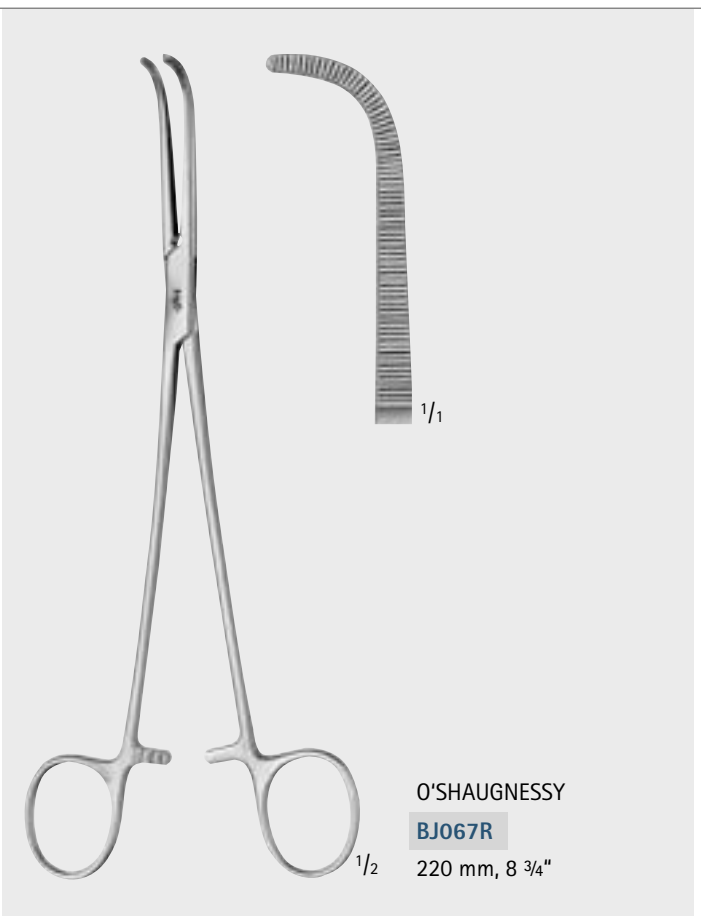
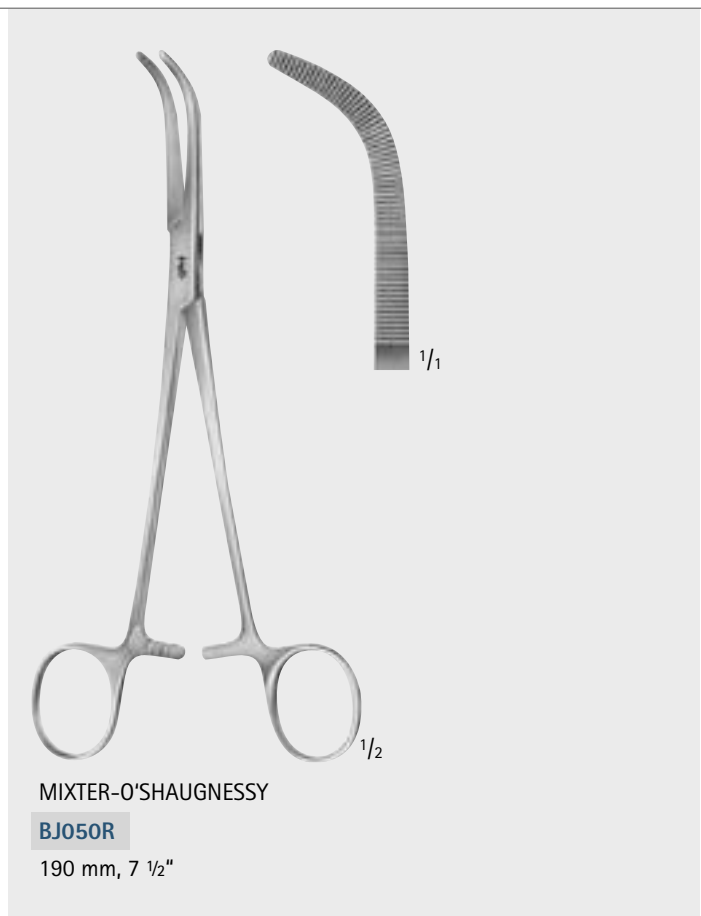

Clamps  
Klemmen

# Clips, Clamps – Clips, Klemmen

## Dissecting and Ligature Forceps

### Präparier- und Ligaturklemmen

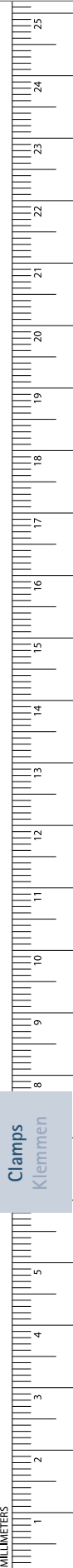
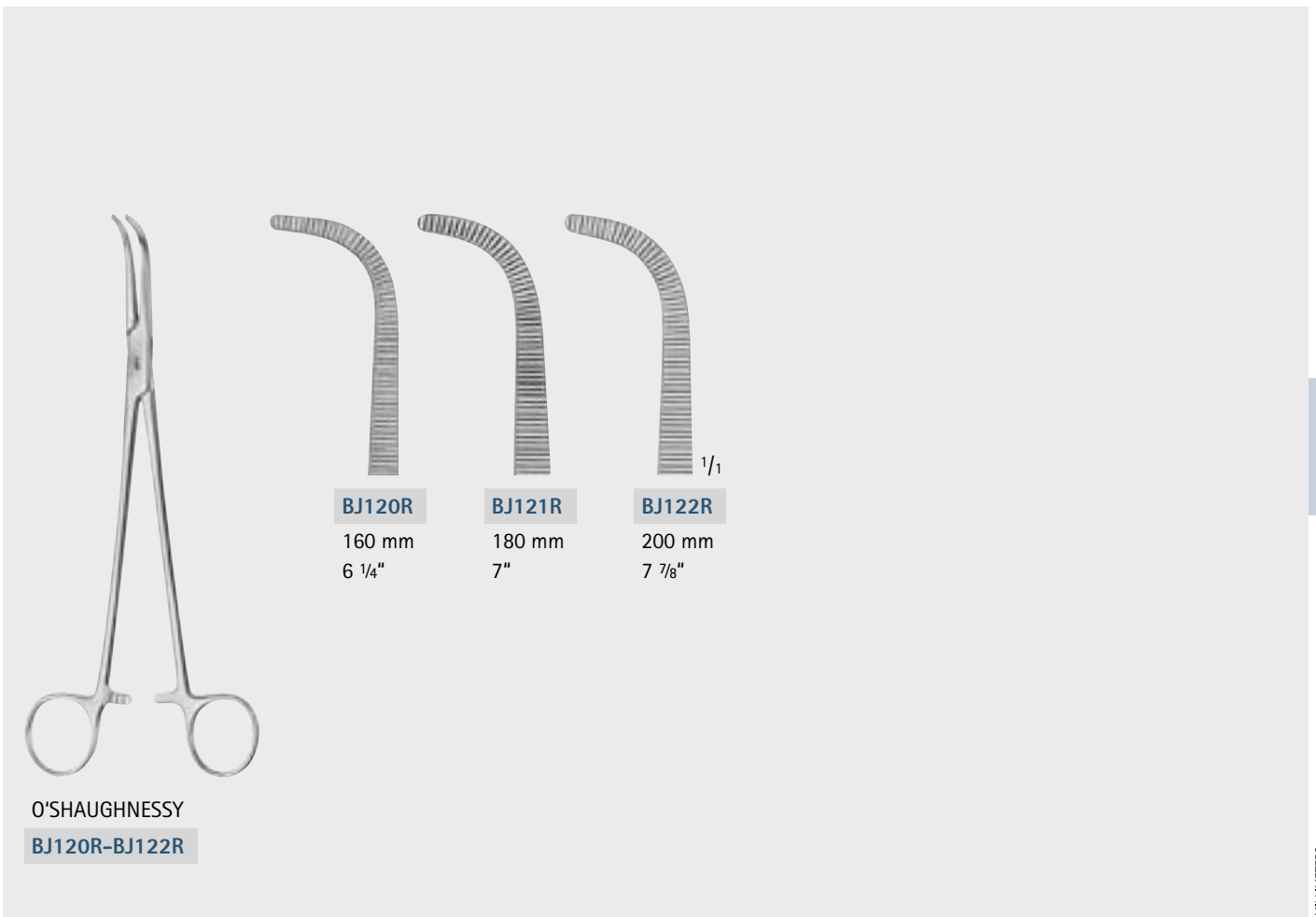
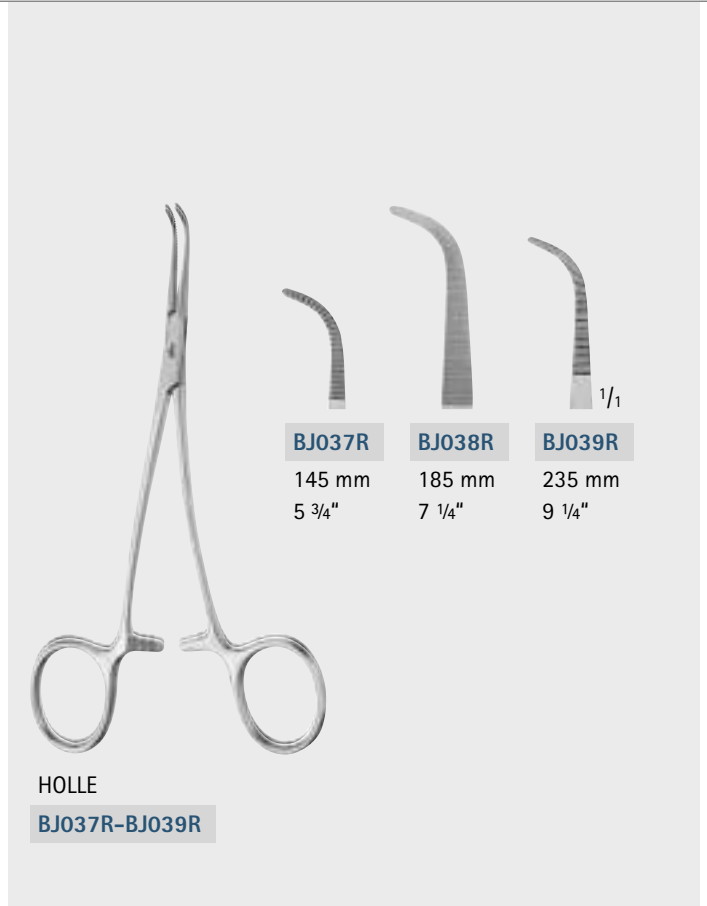
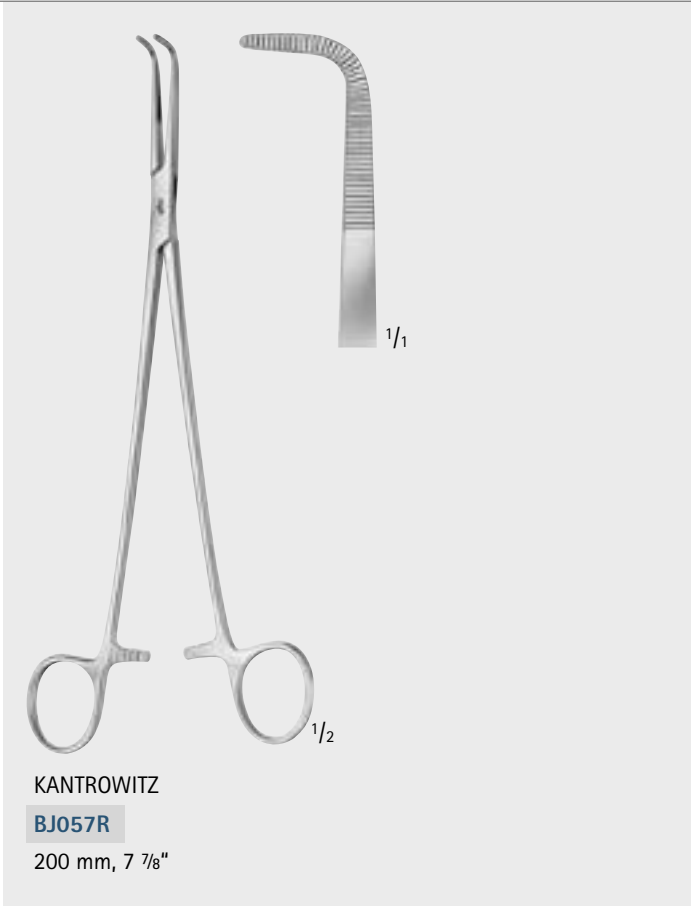

# Clips, Clamps – Clips, Klemmen

## Dissecting and Ligature Forceps

### Präparier- und Ligaturklemmen

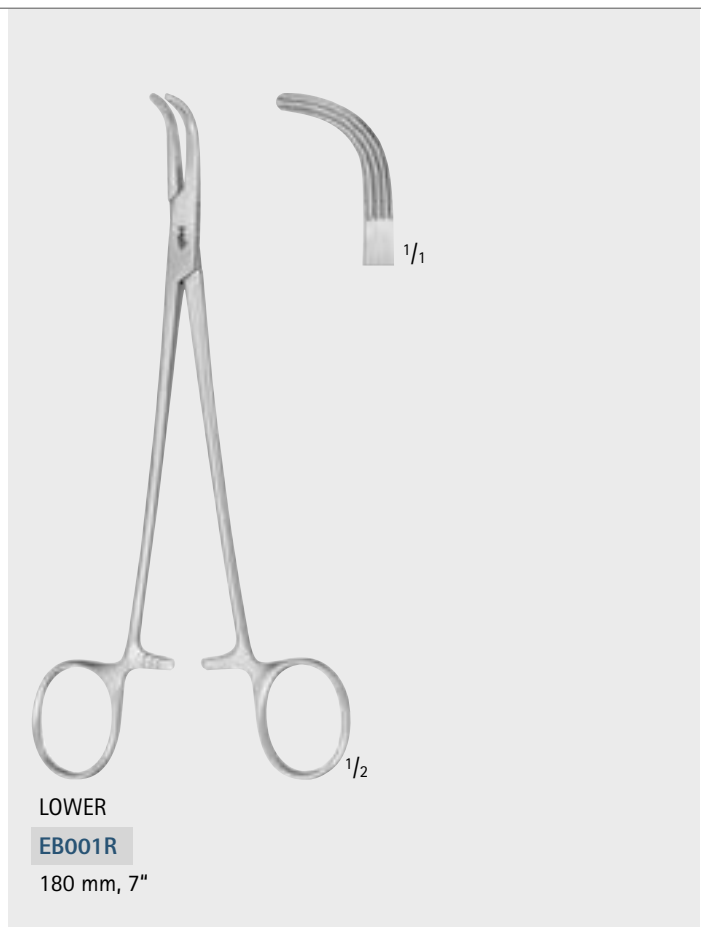
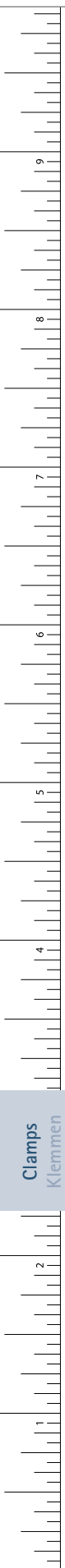

LOWER  
**EB001R**  
180 mm, 7"



LAHEY (SWEET)  
**EB003R**  
200 mm  
7 7/8"

LAHEY  
**BJ060R**  
225 mm  
8 7/8"

**BJ060R, EB003R**

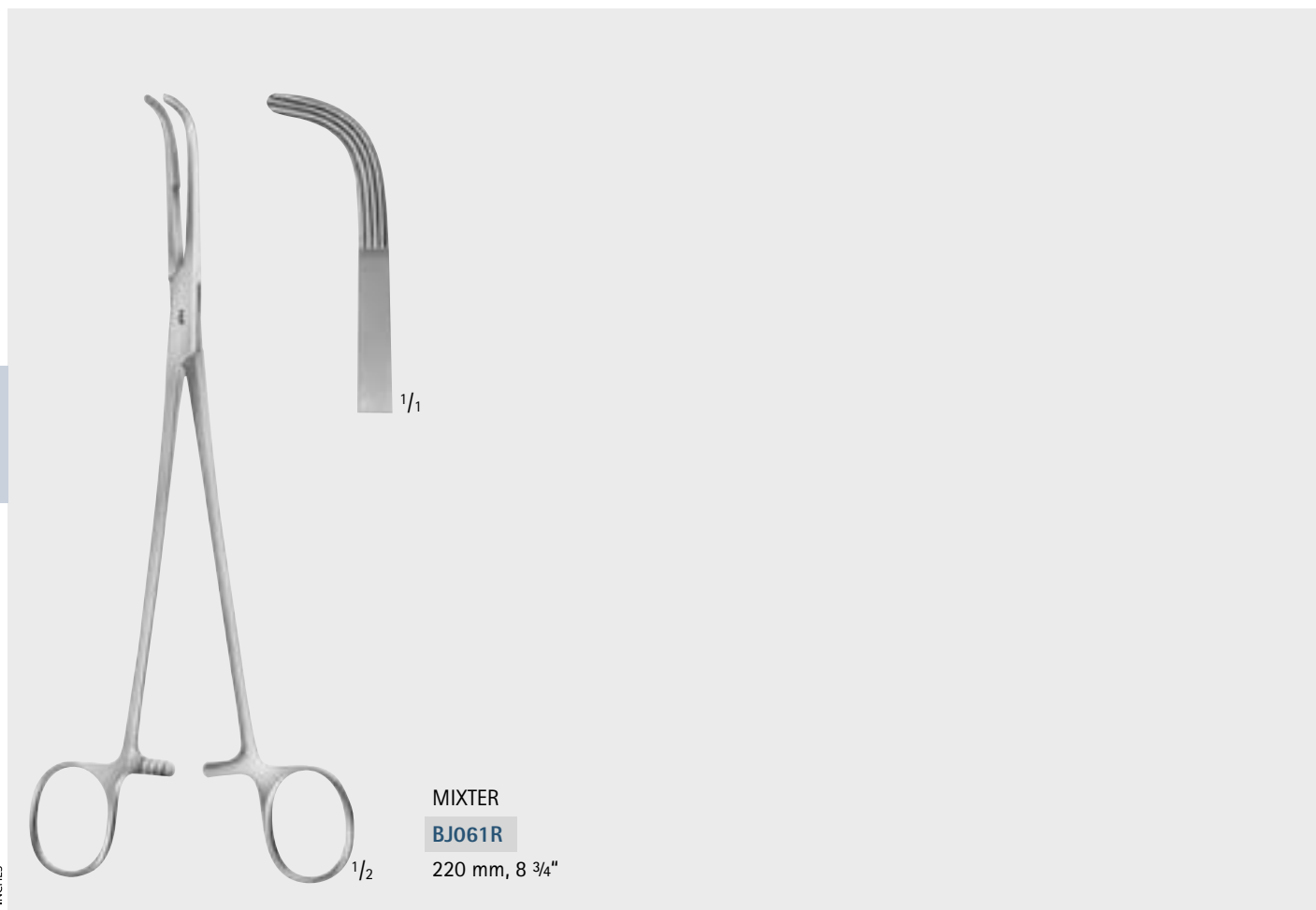

MIXTER  
**BJ061R**  
220 mm, 8 3/4"

Clamps  
Klemmen



# Clips, Clamps – Clips, Klemmen

## Organ and Tissue Grasping Forceps

### Organ- und Gewebefasszangen

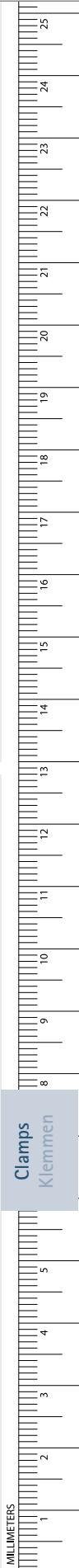
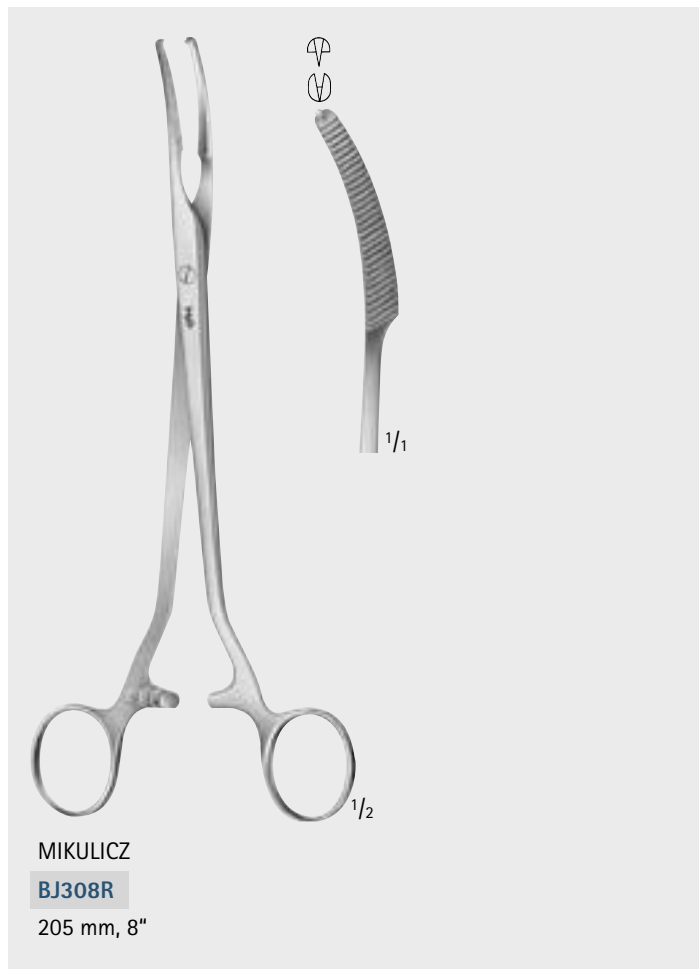
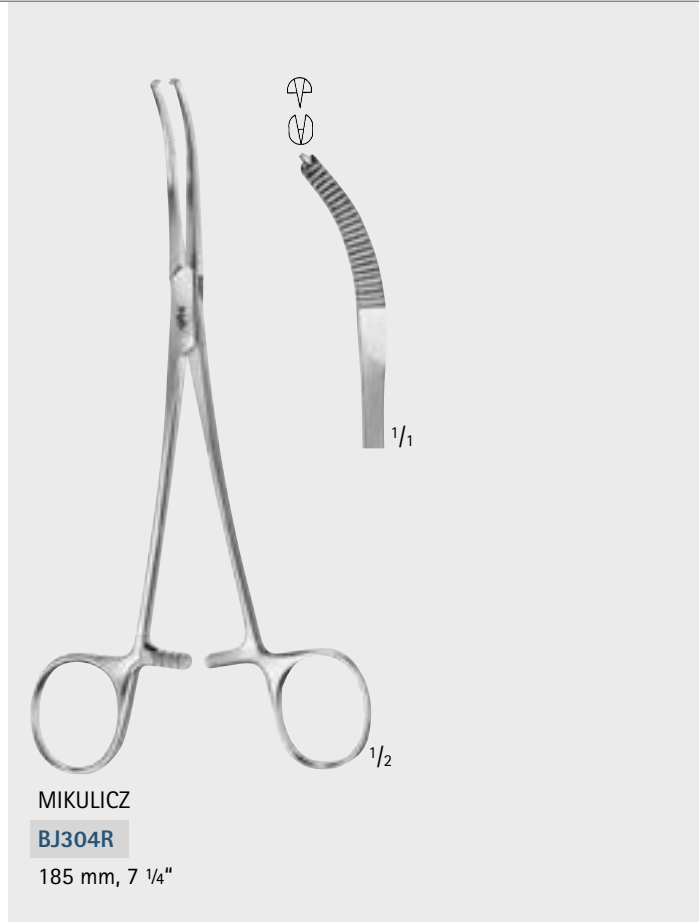
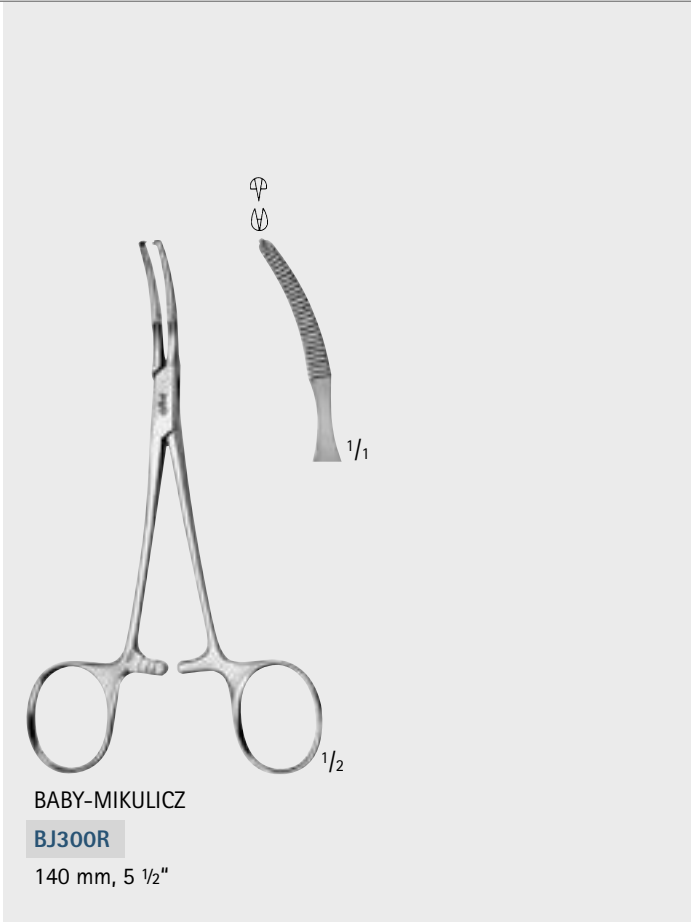

## Clips, Clamps – Clips, Klemmen

### Organ and Tissue Grasping Forceps

### Organ- und Gewebefasszangen



1/1  
2 x 3 teeth,  
sharp  
2 x 3 Zähne,  
scharf

1/2

**CHAPUT**  
**BF300R**  
125 mm, 5"

1/1  
5 x 6 teeth,  
sharp  
5 x 6 Zähne,  
scharf

1/2

**TUFFIER**  
**BF301R**  
125 mm, 5"

1/1  
4 x 5 teeth  
4 x 5 Zähne

1/2

**BABY-ALLIS**  
**EA012R**  
130 mm, 5 1/8"

1/1  
5 x 6 teeth  
5 x 6 Zähne

1/2

**BOYS-ALLIS**  
**EA010R**  
155 mm, 6 1/8"

1/1  
9 x 10 teeth  
9 x 10 Zähne

1/2

**ALLIS-ADAIR**  
**MD568**  
160 mm, 6 1/4"

Clamps  
Klemmen

# Clips, Clamps – Clips, Klemmen

## Organ and Tissue Grasping Forceps

### Organ- und Gewebefasszangen

**EA013R**  
2 x 3 teeth  
2 x 3 Zähne

**EA014R**  
3 x 4 teeth  
3 x 4 Zähne

**EA015R**  
4 x 5 teeth  
4 x 5 Zähne

**EA013R-EA015R**  
155 mm, 6 1/8"

**EA016R**  
155 mm, 6 1/8"

**EA017R**  
190 mm, 7 1/2"

**FB938R**  
220 mm, 8 3/4"

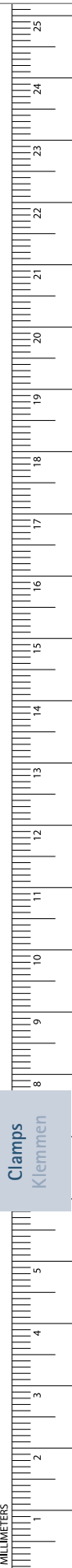

# Clips, Clamps – Clips, Klemmen

## Organ and Tissue Grasping Forceps

### Organ- und Gewebefasszangen



**JUDD-ALLIS**  
**EA025R**  
 155 mm, 6 1/8"

3 x 4 teeth  
 3 x 4 Zähne

1/1

1/2

**JUDD-ALLIS**  
**EA026R**  
 200 mm, 7 7/8"

3 x 4 teeth  
 3 x 4 Zähne

1/1

1/2

**ALLIS-THOMS**  
**EA020R**  
 200 mm, 7 7/8"

6 x 7 teeth  
 6 x 7 Zähne

1/1

1/2

**BABCOCK**  
**EA030R**  
 155 mm, 6 1/8"

8 mm

1/1

1/2

8 mm	10 mm	9 mm
<b>EA031R</b>	<b>EA032R</b>	<b>EA033R</b>
175 mm 6 7/8"	215 mm 8 1/2"	200 mm 7 7/8"

**BABCOCK**  
**EA031R-EA033R**

1/1

1/2

**BABCOCK**  
**FB934R**  
 220 mm, 8 3/4"

14 mm

1/1

1/2

Clamps  
Klemmen

# Clips, Clamps – Clips, Klemmen

## Organ and Tissue Grasping Forceps

### Organ- und Gewebefasszangen

■ ATRAUMATA®

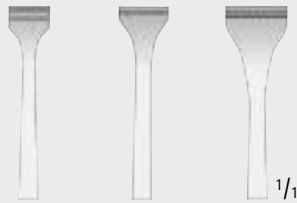

<b>EA092R</b>	<b>EA095R</b>	<b>EA096R</b>
160 mm	200 mm	220 mm
6 1/4"	7 7/8"	8 3/4"

ALLIS  
EA092R-EA096R

■ ATRAUMATA®

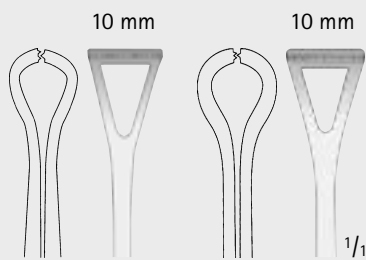

<b>EA050R</b>	<b>EA052R</b>
160 mm	215 mm
6 1/4"	8 1/2"

BABCOCK  
EA050R-EA052R



COLLIN  
EA061R  
195 mm, 7 3/4"

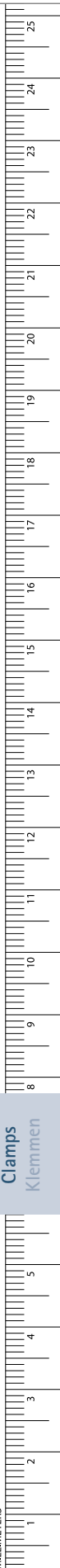

# Clips, Clamps – Clips, Klemmen

## Organ and Tissue Grasping Forceps

### Organ- und Gewebefasszangen



**COLLIN**  
**EA039R**  
140 mm, 5 1/2"

**COLLIN**  
**EA040R**  
180 mm, 7"

**LOCKWOOD**  
**EA036R**  
200 mm, 7 7/8"

**EA041R**  
195 mm  
7 3/4"

**EA042R**  
200 mm  
7 7/8"

**DUVAL-COLLIN**  
**EA041R-EA042R**

**PENNINGTON**  
**BH902R**  
155 mm, 6 1/8"

**PENNINGTON**  
**EA037R**  
200 mm, 7 7/8"

Clamps  
Klemmen

# Clips, Clamps – Clips, Klemmen

## Organ and Tissue Grasping Forceps

### Organ- und Gewebefasszangen

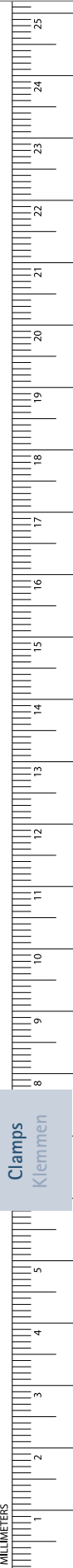
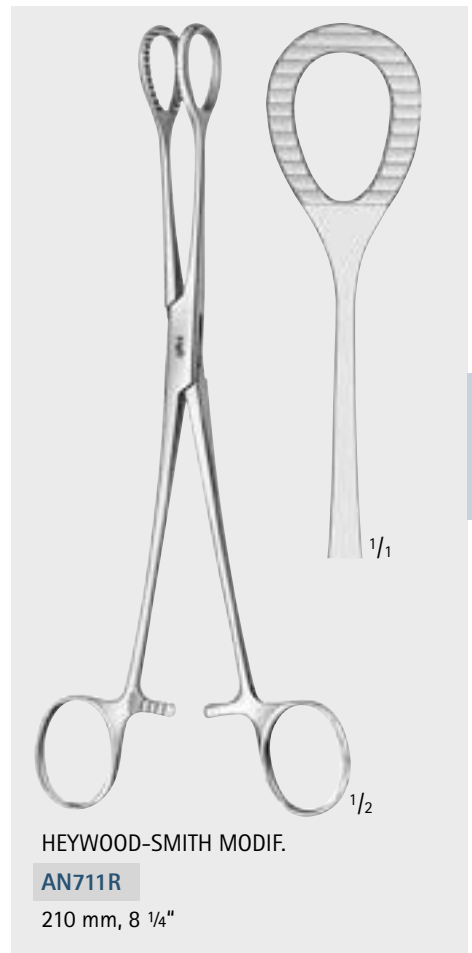
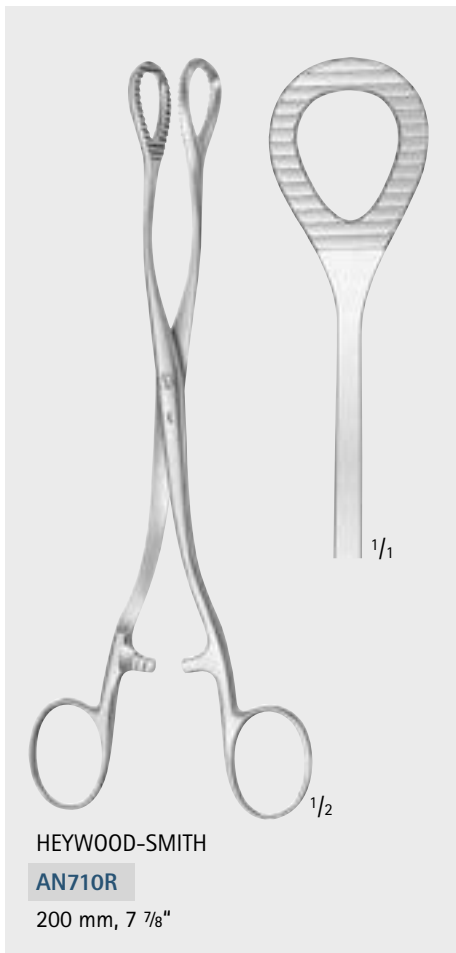
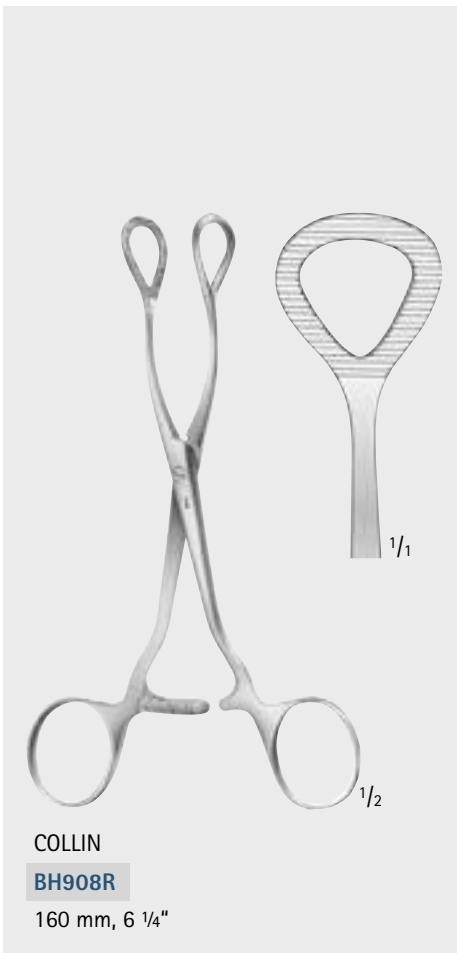
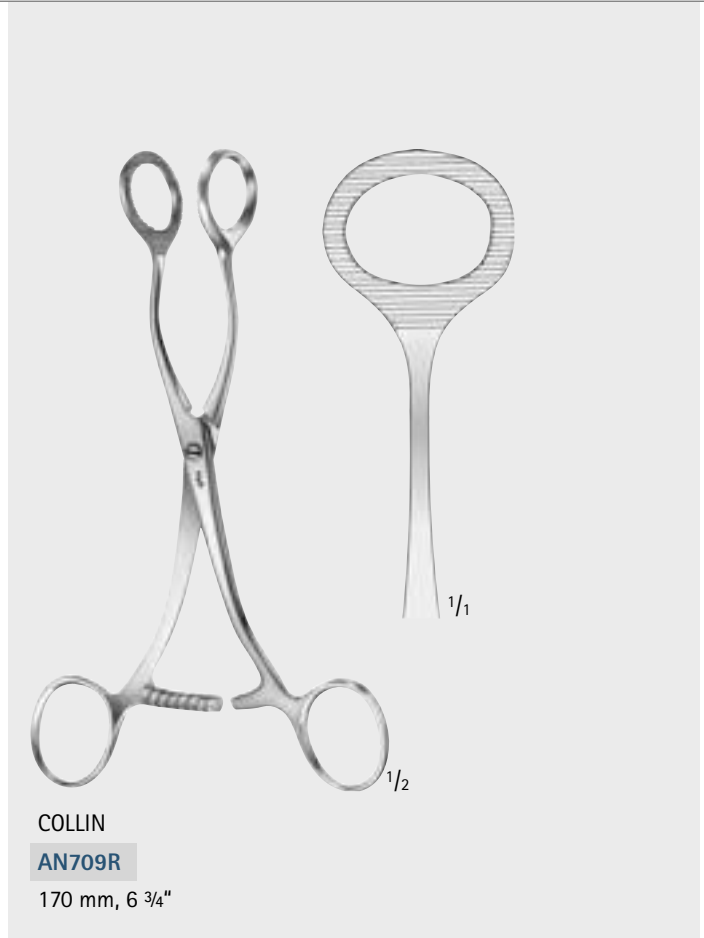
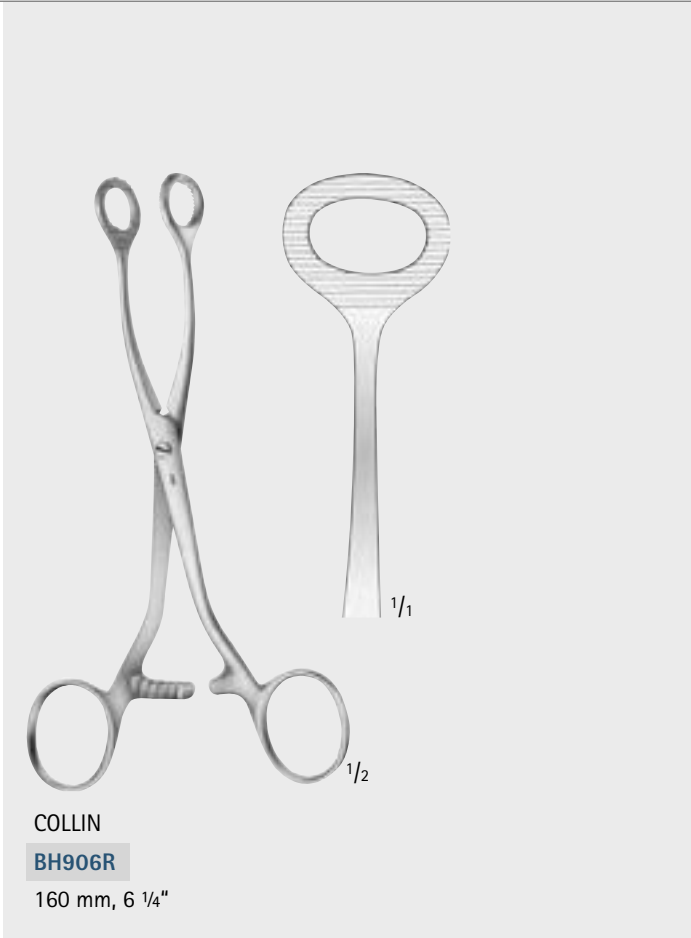

# Clips, Clamps – Clips, Klemmen

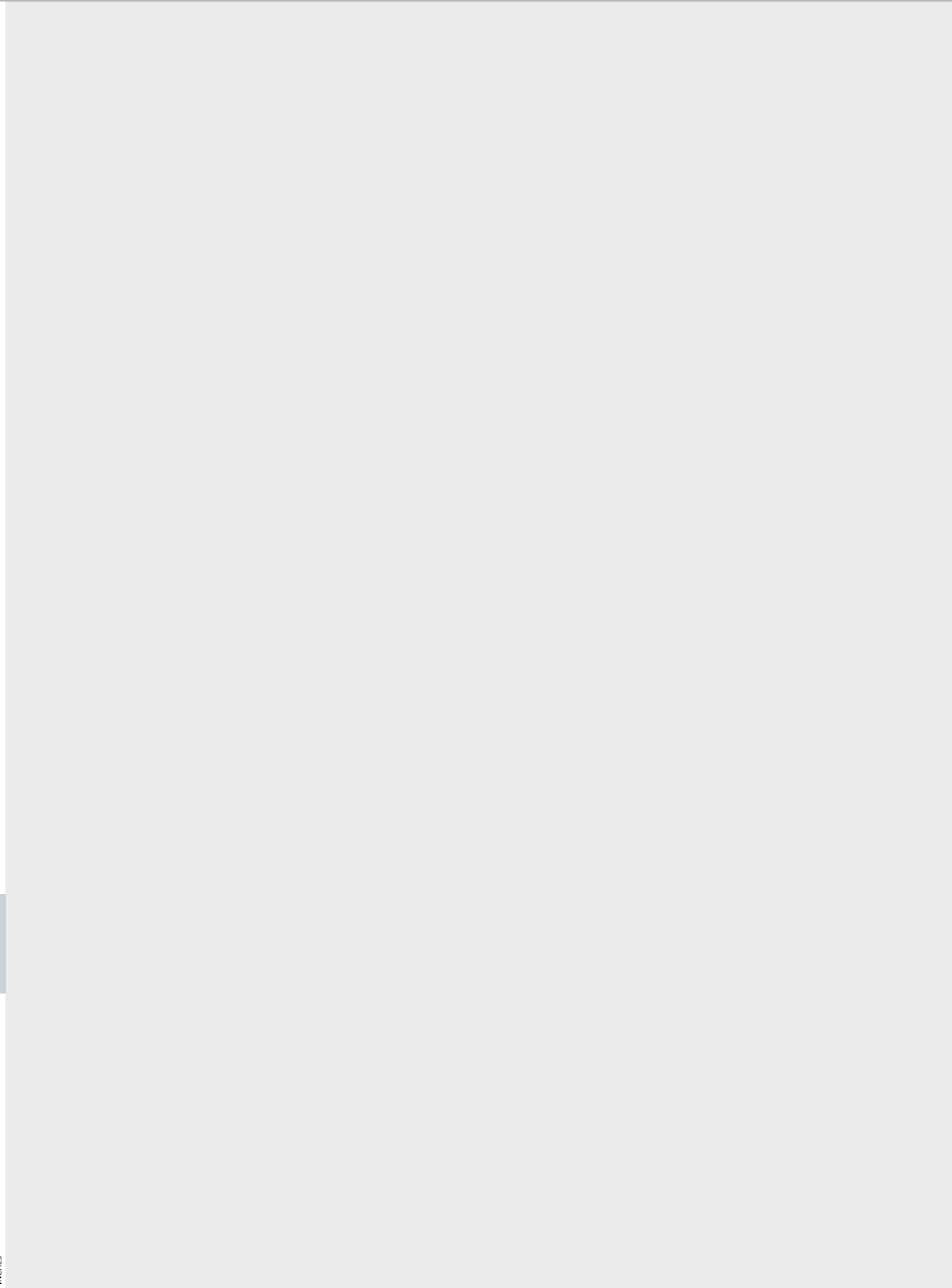



## General Surgical Instruments Chirurgische Instrumente

- Needle Holders
- Nadelhalter

# Needle Holders, Ligature Instruments – Nadelhalter, Ligatur-Instrumente

## DUROGRIP® Needle Holders

## DUROGRIP® Nadelhalter

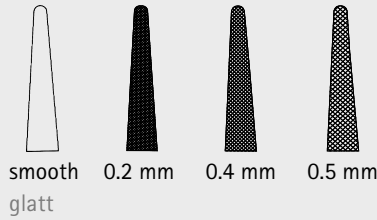
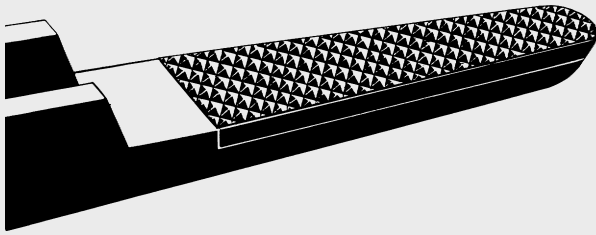

smooth 0.2 mm 0.4 mm 0.5 mm  
glatt

- Aesculap needle holders have jaws with tungsten carbide inserts and according to the use required the resp. structure can be chosen. A smooth jaw surface as well as 3 different serrations ensure a sure „grip“ of the resp. needle.
- Aesculap Nadelhalter sind durch die Struktur der Hartmetall-Maulteile auf das jeweilige, indikationsbezogene Nahtmaterial abgestimmt. Eine glatte Maulfläche sowie 3 verschiedene Haftprofile garantieren den sicheren „Grip“ der jeweiligen Nadel.

- We recommend tungsten carbide inserts
  - with smooth jaw surface for suture material 9/0 - 11/0
  - with 0.2 mm pitch of serration for suture material 6/0 - 10/0
  - 0.4 mm 4/0 - 6/0
  - 0.5 mm up to 3/0
- Wir empfehlen Hartmetall-Maulteile
  - mit glatter Fläche für Nahtmaterial 9/0 - 11/0
  - mit Teilung 0,2 mm für Nahtmaterial 6/0 - 10/0
  - 0,4 mm 4/0 - 6/0
  - 0,5 mm bis 3/0



### DUROGRIP® Needle holders with tungsten carbide inserts

- Identification:
  - gold-plated rings, handle ends and ratchets
- DUROGRIP® Nadelhalter mit Hartmetall-Plättchen
- Kennzeichnung:
  - Vergoldete Ringe, Branchenenden und Sperren

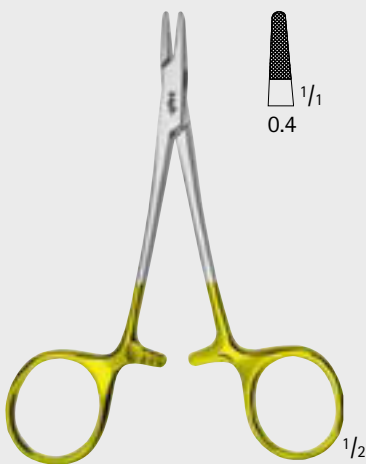

1/1  
0.4

DERF  
BM008R  
120 mm, 4 3/4"



1/1

with smooth jaw  
mit glattem Maul

HALSEY  
BM010R  
120 mm, 4 3/4"

# Needle Holders, Ligature Instruments – Nadelhalter, Ligatur-Instrumente

DUROGRIP® Needle Holders

DUROGRIP® Nadelhalter

**MASING**  
**BM009R**  
 130 mm, 5 1/8"

**CONVERSE**  
**BM011R**  
 130 mm, 5 1/8"

**HALSEY**  
**BM012R**  
 130 mm, 5 1/8"

**BM014R**  
 with smooth jaws  
 mit glattem Maul

**BM024R**

**WEBSTER**  
**BM014R-BM024R**  
 130 mm, 5 1/8"

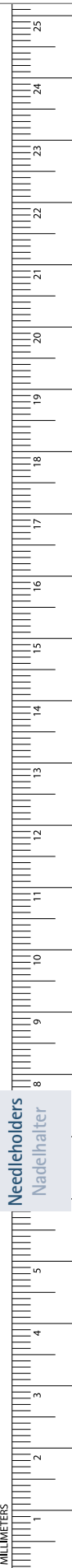

Needleholders  
 Nadelhalter

MILLIMETERS

# Needle Holders, Ligature Instruments – Nadelhalter, Ligatur-Instrumente

## DUROGRIP® Needle Holders

## DUROGRIP® Nadelhalter

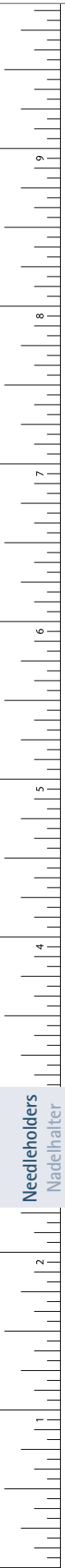
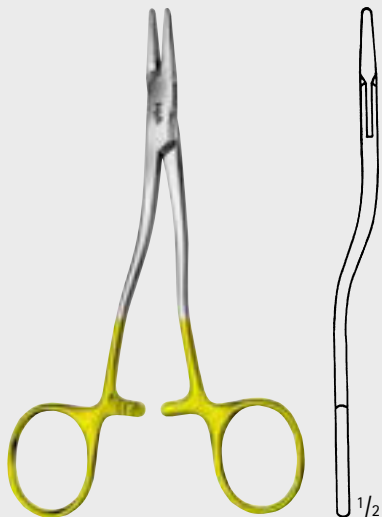
**KILNER**  
**BM018R**  
135 mm, 5 1/4"

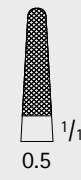

1/1  
0.5



**BAUMGARTNER**  
**BM015R**  
145 mm, 5 3/4"



1/1  
0.5



**BABY-CRILE-WOOD**  
**BM013R**  
150 mm, 6"



1/1  
0.4



**CRILE-WOOD**  
**BM016R-BM019R**

		
0.4	0.4	1/1 0.4
<b>BM016R</b>	<b>BM017R</b>	<b>BM019R</b>
145 mm	185 mm	200 mm
5 3/4"	7 1/4"	7 7/8"

Needleholders  
Nadelhalter

# Needle Holders, Ligature Instruments – Nadelhalter, Ligatur-Instrumente

DUROGRIP® Needle Holders

DUROGRIP® Nadelhalter

**SAROT**  
**BM020R-BM023R**

<b>BM020R</b>	<b>BM023R</b>
180 mm	260 mm
7"	10 1/4"

**HEGAR-MAYO-SEELEY**  
**BM022R**

205 mm, 8"

**HEGAR-MAYO**  
**BM065R-BM067R**

<b>BM065R</b>	<b>BM066R</b>	<b>BM067R</b>
150 mm	185 mm	205 mm
6"	7 1/4"	8"

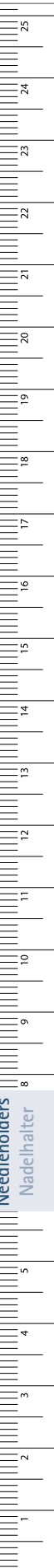

Needleholders  
Nadelhalter

MILLIMETERS

# Needle Holders, Ligature Instruments – Nadelhalter, Ligatur-Instrumente

## DUROGRIP® Needle Holders

### DUROGRIP® Nadelhalter

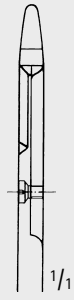

with smooth jaws  
mit glattem Maul

**BM127R**  
125 mm, 5"

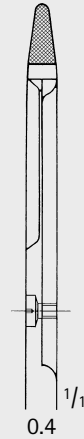

HEGAR-OLSEN MODIF. LANGE  
**BM128R**  
145 mm, 5 3/4"

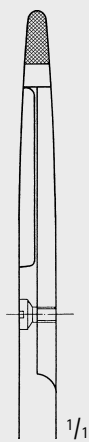

0.4  
1 blade fine serrated  
1 Blatt fein gezahnt

HEGAR-OLSEN  
**BM124R**  
165 mm, 6 1/2"

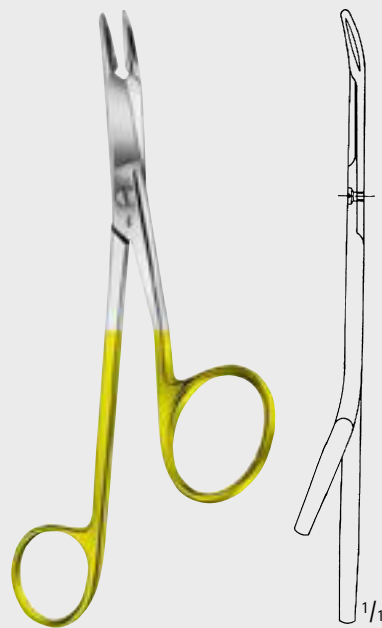

GILLIES  
**BM129R**  
160 mm, 6 1/4"

Needleholders  
Nadelhalter

# Needle Holders, Ligature Instruments – Nadelhalter, Ligatur-Instrumente

DUROGRIP® Needle Holders

DUROGRIP® Nadelhalter

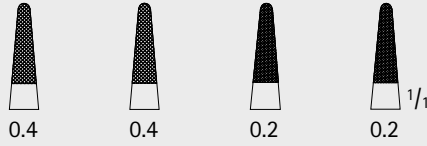
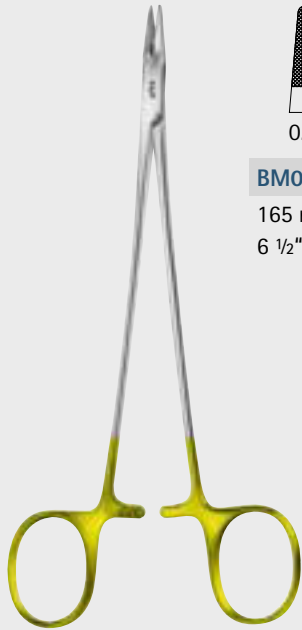

<b>BM033R</b>	<b>BM034R</b>	<b>BM063R</b>	<b>BM064R</b>
165 mm	210 mm	165 mm	210 mm
6 1/2"	8 1/4"	6 1/2"	8 1/4"

DE BAKEY

**BM033R-BM064R**

very delicate  
sehr fein

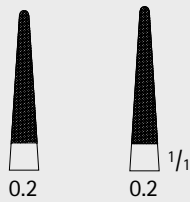

<b>BM025R</b>	<b>BM026R</b>
180 mm	200 mm
7"	7 7/8"

**BM025R-BM026R**

very delicate  
sehr fein

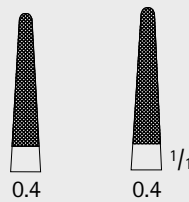
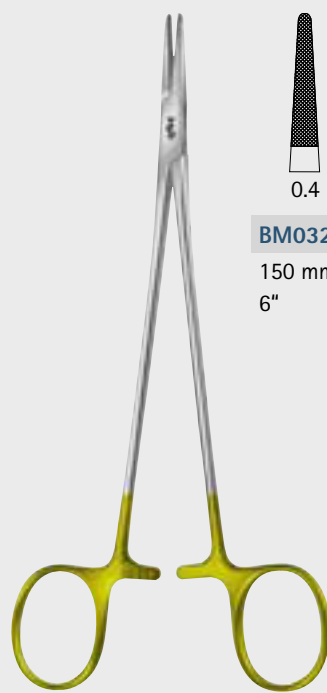

<b>BM032R</b>	<b>BM035R</b>
150 mm	180 mm
6"	7"

DE BAKEY

**BM032R-BM035R**

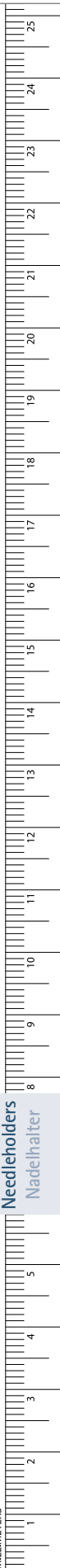

Needleholders  
Nadelhalter

MILLIMETERS

# Needle Holders, Ligature Instruments – Nadelhalter, Ligatur-Instrumente

## DUROGRIP® Needle Holders

### DUROGRIP® Nadelhalter

- These special patterns with extremely fine jaws are suitable for holding non-traumatic needles and fine vascular needles.
- Diese Spezialmodelle mit extra schmalen Mäulern eignen sich für atraumatische Nadeln und für feine Gefäßnadeln.

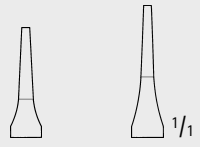

<b>BM074R</b>	<b>BM075R</b>
150 mm	180 mm
6"	7"

RYDER

**BM074R-BM075R**

with smooth jaws  
mit glattem Maul

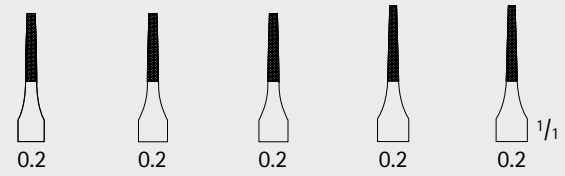

<b>BM054R</b>	<b>BM055R</b>	<b>BM056R</b>	<b>BM057R</b>	<b>BM058R</b>
135 mm	155 mm	175 mm	210 mm	230 mm
5 1/4"	6 1/8"	6 7/8"	8 1/4"	9"

RYDER

**BM054R-BM058R**

very delicate  
sehr fein

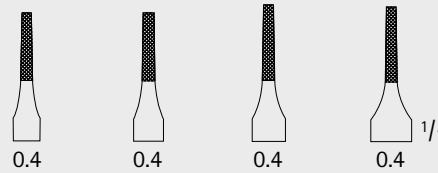

<b>BM044R</b>	<b>BM045R</b>	<b>BM046R</b>	<b>BM047R</b>
135 mm	175 mm	195 mm	265 mm
5 1/4"	6 7/8"	7 3/4"	10 1/2"

RYDER

**BM044R-BM047R**

Needleholders  
Nadelhalter



# Needle Holders, Ligature Instruments – Nadelhalter, Ligatur-Instrumente

## Dia Dust® Needle Holders

### Dia Dust® Nadelhalter



■ All needle holder jaws are coated with Aesculap Dia Dust®. This coating ensures that the inner surfaces provide the best possible performance in hardness and wear resistance. The texture of the jaws greatly increases its surface area, allowing you to grasp fine needles safely and securely. The needle quickly aligns itself in an ideal position in the rough surface.

■ Die Dia Dust®-Beschichtung sorgt für eine noch härtere und verschleißfestere Maulinnenfläche. Darüberhinaus unterstützt die Struktur der Dia Dust®-Beschichtung ein zuverlässiges Fassen von feinen Nadeln.

- Titanium
- Titan



<b>BM385T</b>	<b>BM386T</b>	<b>BM387T</b>
160 mm 6 1/4"	180 mm 7"	210 mm 8 1/4"

RYDER

**BM385T-BM387T**

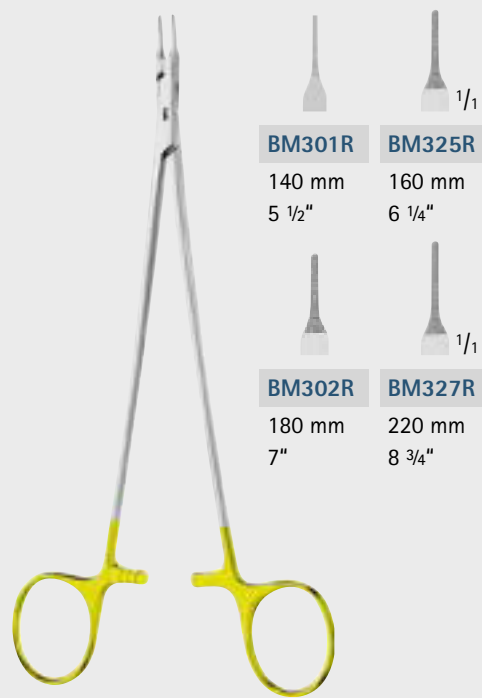

<b>BM301R</b>	<b>BM325R</b>
140 mm 5 1/2"	160 mm 6 1/4"
<b>BM302R</b>	<b>BM327R</b>
180 mm 7"	220 mm 8 3/4"

RYDER

**BM301R-BM327R**

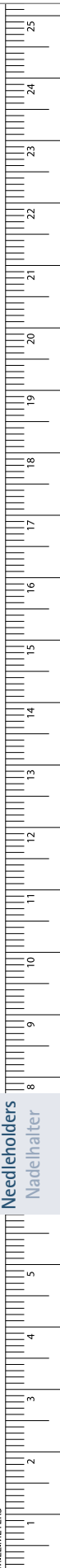

Needleholders  
Nadelhalter

MILLIMETERS

# Needle Holders, Ligature Instruments – Nadelhalter, Ligatur-Instrumente

## DUROGRIP® Needle Holders

### DUROGRIP® Nadelhalter

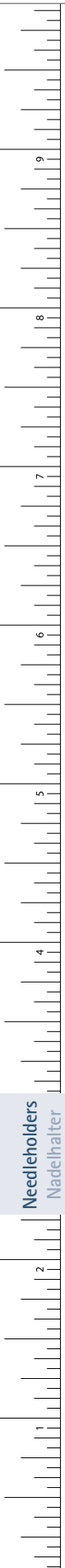

**TÖNNIS**  
**BM186R**  
 elastic pattern  
 elastisches Modell  
 180 mm, 7"

**TÖNNIS MODIF.**  
**BM183R**  
 elastic pattern  
 elastisches Modell  
 180 mm, 7"

**LANGENBECK**  
**BM191R-BM193R**  
 180 mm 200 mm  
 7" 7 7/8"

■ **grazil**

**LANGENBECK**  
**BM196R**  
 200 mm, 7 7/8"

# Needle Holders, Ligature Instruments – Nadelhalter, Ligatur-Instrumente

## DUROGRIP® Needle Holders

### DUROGRIP® Nadelhalter



<b>BM148R</b>	<b>BM150R</b>	<b>BM153R</b>
140 mm	170 mm	200 mm
5 1/2"	6 1/2"	7 7/8"

**MATHIEU**  
**BM148R-BM153R**  
 delicate patterns  
 feine Modelle

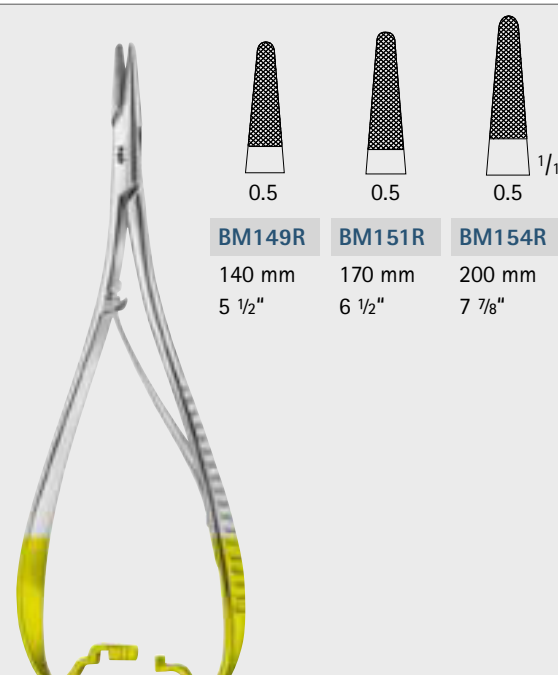

<b>BM149R</b>	<b>BM151R</b>	<b>BM154R</b>
140 mm	170 mm	200 mm
5 1/2"	6 1/2"	7 7/8"

**MATHIEU**  
**BM149R-BM154R**  
 Standard patterns  
 Standard-Modelle

■ grazil



**LICHTENBERG**  
**BM132R**  
 elastic pattern  
 elastisches Modell  
 195 mm, 7 3/4"



**HÖSEL**  
**BM165R**  
 with long neck  
 mit langem Hals  
 205 mm, 8"

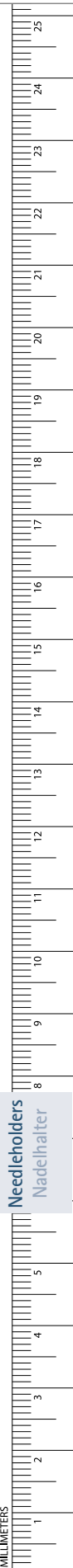

# Needle Holders, Ligature Instruments – Nadelhalter, Ligatur-Instrumente

## Ligature Needles

### Unterbindungsnadeln



Needleholders  
Nadelhalter



**KRONECKER**  
**BM801R**  
for right hand  
blunt  
für rechte Hand  
stumpf  
155 mm, 6 1/8"



**KRONECKER**  
**BM802R**  
for left hand  
blunt  
für linke Hand  
stumpf  
155 mm, 6 1/8"



**DESCHAMPS**  
**BM810R**  
for right hand  
blunt  
für rechte Hand  
stumpf  
215 mm, 8 1/2"



**DESCHAMPS**  
**BM811R**  
for left hand  
blunt  
für linke Hand  
stumpf  
215 mm, 8 1/2"

# Needle Holders, Ligature Instruments – Nadelhalter, Ligatur-Instrumente

## Ligature Needles

### Unterbindungsnadeln



DESCHAMPS

**BM806R**

for right hand  
blunt  
für rechte Hand  
stumpf  
215 mm, 8 1/2"

DESCHAMPS

**BM807R**

for left hand  
blunt  
für linke Hand  
stumpf  
215 mm, 8 1/2"

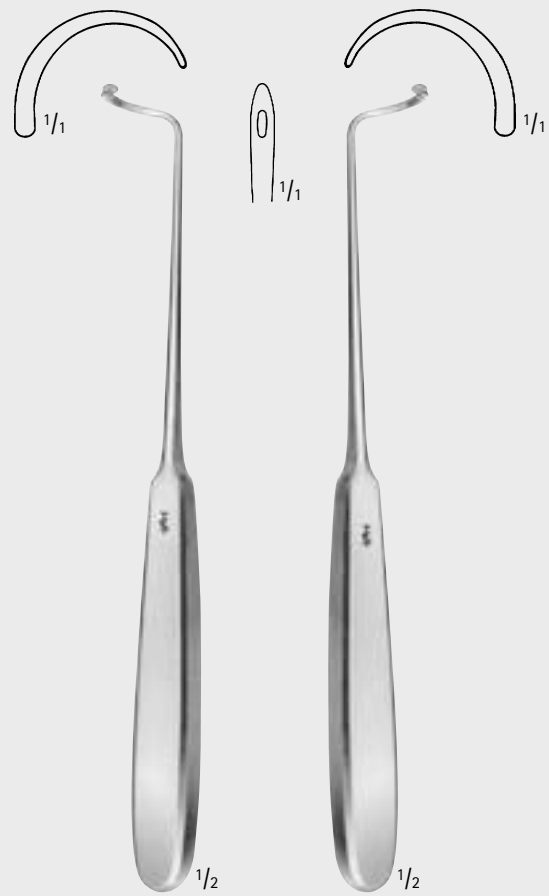

DESCHAMPS

**BM808R**

for right hand  
blunt  
für rechte Hand  
stumpf  
210 mm, 8 1/4"

DESCHAMPS

**BM809R**

for left hand  
blunt  
für linke Hand  
stumpf  
210 mm, 8 1/4"

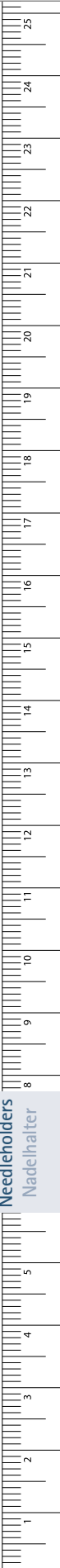

# Needle Holders, Ligature Instruments – Nadelhalter, Ligatur-Instrumente

## Ligature Needles

### Unterbindungsnadeln



Needleholders  
Nadelhalter

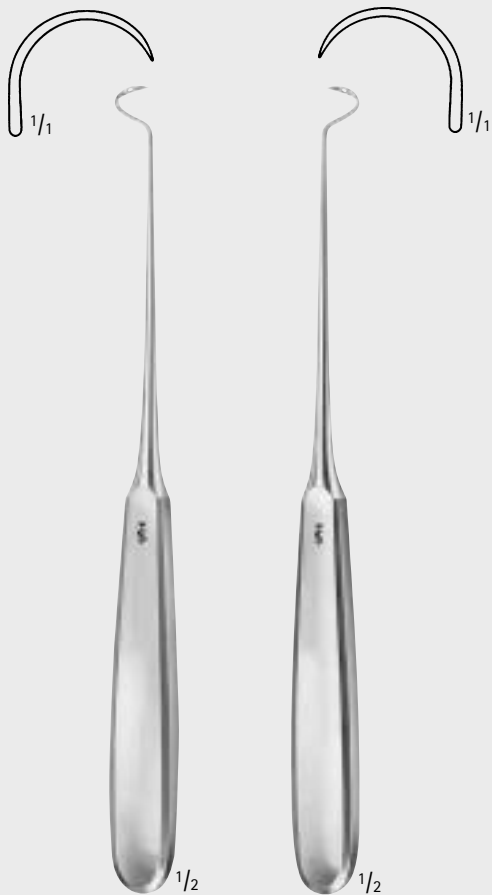

**HURD**  
**BM770R**  
for right hand  
sharp  
für rechte Hand  
scharf  
210 mm, 8 1/4"

**HURD**  
**BM771R**  
for left hand  
sharp  
für linke Hand  
scharf  
210 mm, 8 1/4"



**DESCHAMPS**  
**BM780R**  
for right hand  
sharp  
für rechte Hand  
scharf  
210 mm, 8 1/4"

**DESCHAMPS**  
**BM781R**  
for left hand  
sharp  
für linke Hand  
scharf  
210 mm, 8 1/4"

# Needle Holders, Ligature Instruments – Nadelhalter, Ligatur-Instrumente

## Guiding Probes

## Führungshohlsonden

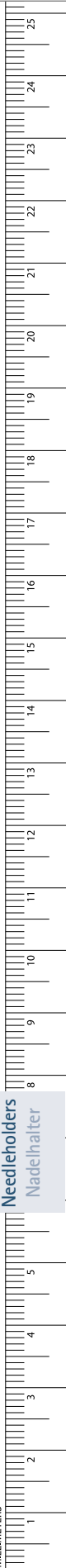
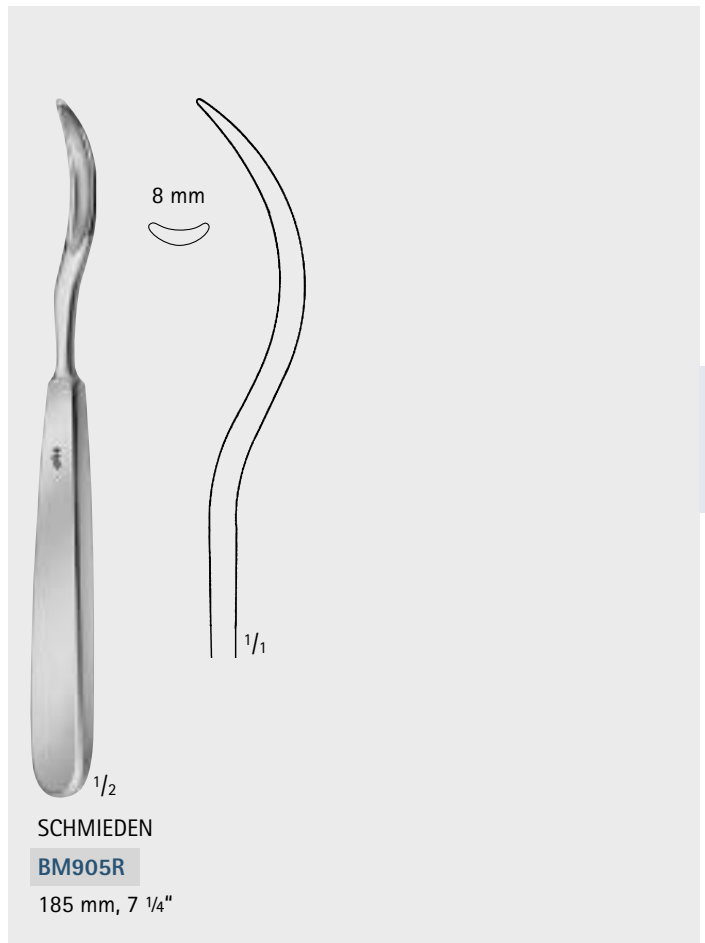
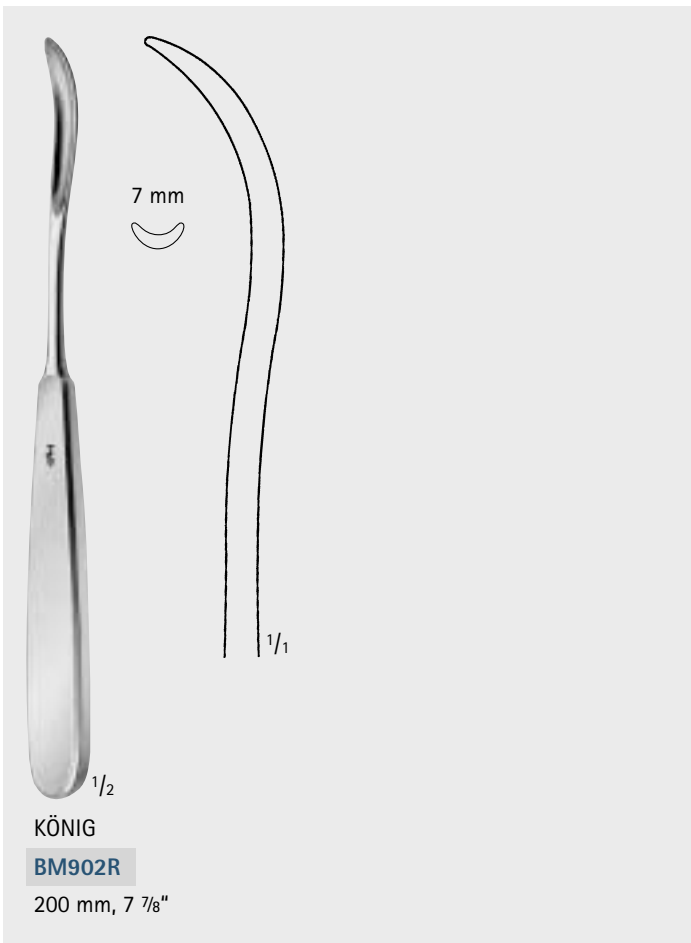
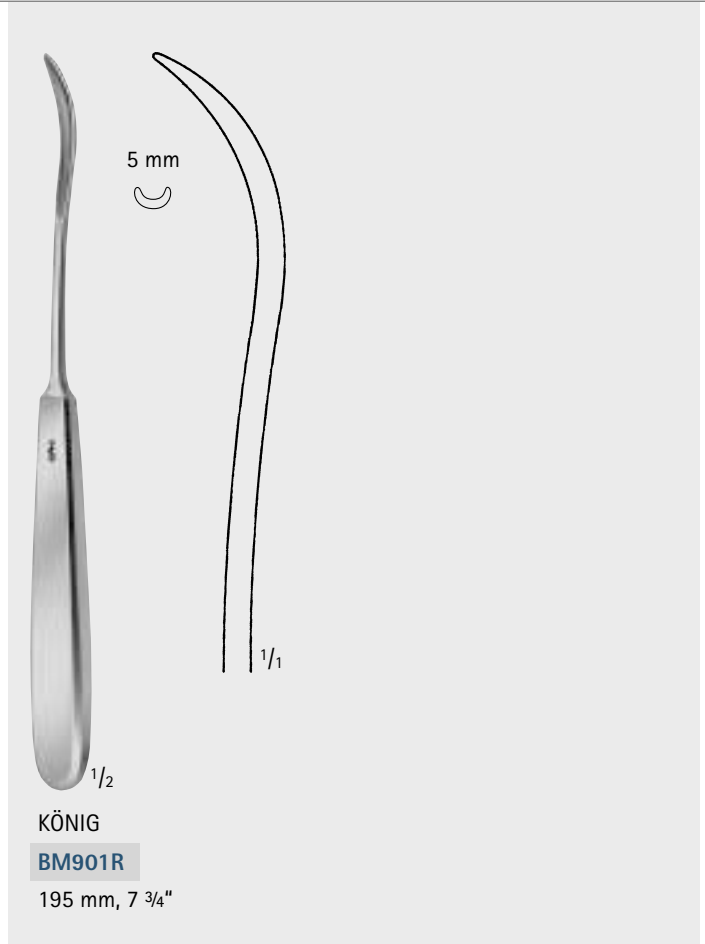
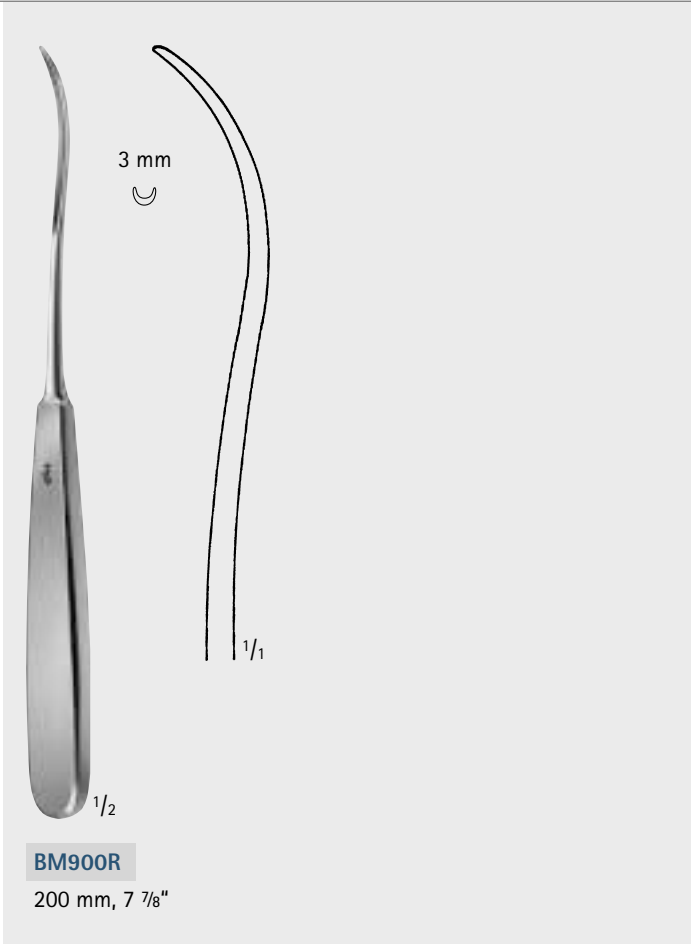

# Needle Holders, Ligature Instruments – Nadelhalter, Ligatur-Instrumente

## Guiding Probes

### Führungshohlsonden

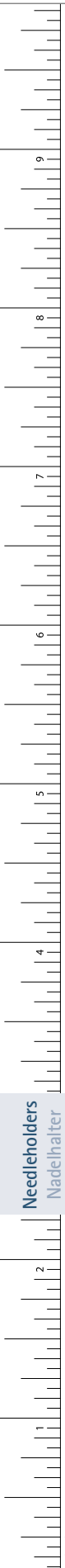

11 mm

1/2

**KOCHER**

**BM911R**

150 mm, 6"

12 mm

1/2

**KOCHER**

**BM913R**

170 mm, 6 3/4"

5 mm

1/2

**PAYR**

**BM920R**

195 mm, 7 3/4"

5 mm

1/2

**PAYR**

**BM922R**

225 mm, 8 7/8"

6 mm

1/2

**BM938P**

230 mm, 9"

8 mm

1/2

**BM940P**

165 mm, 6 1/2"

9 mm

1/2

**BM941P**

250 mm, 9 3/4"

Needleholders  
Nadelhalter



## General Surgical Instruments Chirurgische Instrumente

- Probes
- Sonden

# Probes, Cotton Carriers, Redon Spikes – Sonden, Watteträger, Redon Spieße

## Directors

### Hohlsonden



Probes  
Sonden

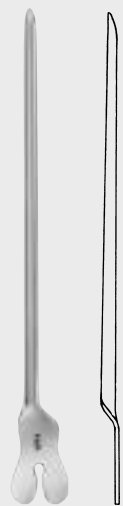

Art. No. Art. Nr.	Length Länge
<b>BN003R</b>	130 mm, 5 1/8"
<b>BN004R</b>	145 mm, 5 3/4"
<b>BN006R</b>	160 mm, 6 1/4"

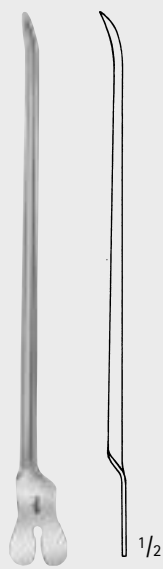

**DOYEN**  
**BN010R**  
145 mm, 5 3/4"

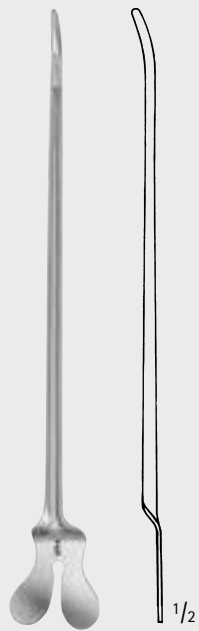

**NELATON**  
**BN012R**  
160 mm, 6 1/4"

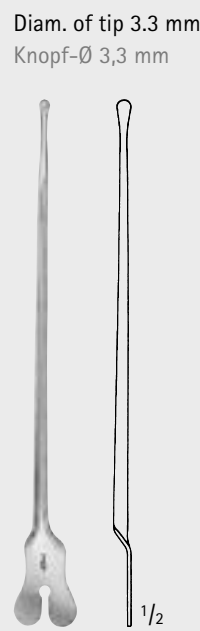

Diam. of tip 3.3 mm  
Knopf-Ø 3,3 mm

**BN015R**  
with tip  
mit Knopf  
140 mm, 5 1/2"

Diam. of tip 3.5 mm  
Knopf-Ø 3,5 mm

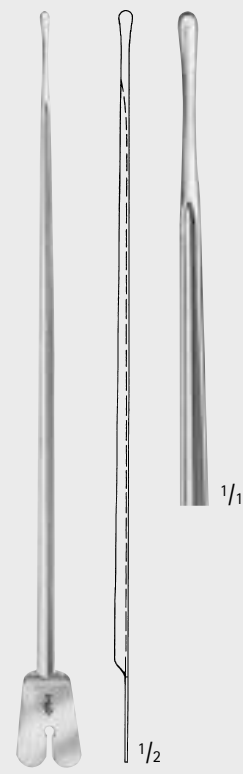

**BRODIE**  
**BN020R**  
with tip  
mit Knopf  
200 mm, 7 7/8"

# Probes, Cotton Carriers, Redon Spikes – Sonden, Watteträger, Redon Spieße

Probes

Sonden



Art. No. Art. Nr.	Diam. of tip (mm) Knopf-Ø (mm)	Length Länge
<b>BN034R</b>	2.5	145 mm, 5 3/4"
<b>BN036R</b>	2.5	160 mm, 6 1/4"
<b>BN040R</b>	3.0	200 mm, 7 7/8"

Probes with eye  
Öhrsonden



1/2

**MB603R**  
125 mm, 5"

Diam. of tip 1.5 mm  
Knopf-Ø 1,5 mm



1/2

**BN054R**  
Myrtle leaf probe  
Myrtenblattsonde  
145 mm, 5 3/4"

Diam. of tip 2 mm  
Knopf-Ø 2 mm



Art. No. Art. Nr.	Length Länge
<b>BN063R</b>	130 mm, 5 1/8"
<b>BN064R</b>	145 mm, 5 3/4"
<b>BN066R</b>	160 mm, 6 1/4"
<b>BN068R</b>	180 mm, 7"
<b>BN070R</b>	200 mm, 7 7/8"

Myrtle leaf probes  
Myrtenblattsonden

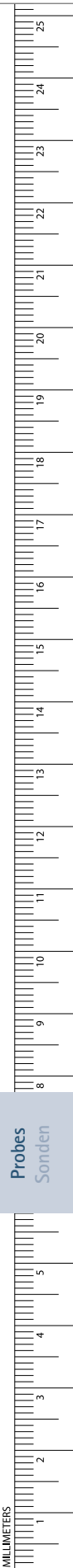

# Probes, Cotton Carriers, Redon Spikes – Sonden, Watteträger, Redon Spieße

Probes

Sonden

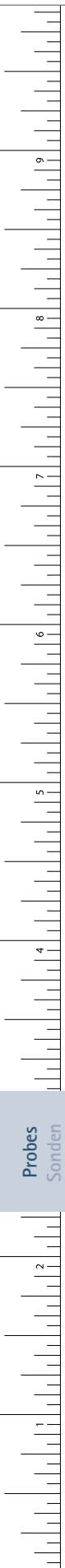

Probes  
Sonden



	Diam. of tip Kopf-Ø			Length Länge
	1 mm	1.5 mm	2.0 mm	
-		BN113R	-	130 mm, 5 1/8"
BN104R	BN114R	BN134R		145 mm, 5 3/4"
-	BN116R	BN136R		160 mm, 6 1/4"
-	BN118R	BN138R		180 mm, 7"
-	BN120R	BN140R		200 mm, 7 7/8"
-	BN125R	-		250 mm, 9 3/4"
-	-	BN150R		300 mm, 11 3/4"

Probes  
Knopfsonden

Diam. of tip 1.2 mm  
Knopf-Ø 1,2 mm



1/2

**BN110**

Sinus probe  
Sinus-Knopfsonde  
150 mm, 6"

Diam. of tip 3 mm  
Knopf-Ø 3 mm



1/2

**BN090R**

Double ended probe,  
malleable, with hole  
Doppelknopfsonde,  
biegsam, mit Loch  
190 mm, 7 1/2"

# Probes, Cotton Carriers, Redon Spikes – Sonden, Watteträger, Redon Spieße

Probes  
Sonden

Diam. of tip 0.8 mm  
Knopf-Ø 0,8 mm



STACKE

**BN160**

Ear probe  
Ohrsonde  
100 mm, 4"

Diam. of tip 1.5 mm  
Knopf-Ø 1,5 mm



KILLIAN

**BN172R**

Nasal probe, slightly curved  
Nasensonde, leicht gebogen  
165 mm, 6 1/2"

Diam. of tip 1.4 mm  
Knopf-Ø 1,4 mm



**BN170R**

Nasal probe, angled  
Nasensonde, kniegebogen  
160 mm, 6 1/4"

Diam. of tip 1 mm  
Knopf-Ø 1 mm



SEIFFERT

**OM488**

Salivary Probe, Silver  
Speichelgangsonde,  
Silber  
200 mm, 7 7/8"

BOWMAN

Art. No. Art. Nr.	Diam. Ø (mm)	Figure Figur	Length Länge
<b>OB510</b>	0.7 + 0.8	00/0	130 mm, 5 1/8"
<b>OB511</b>	0.9 + 1.1	1/2	130 mm, 5 1/8"
<b>OB512</b>	1.3 + 1.4	3/4	130 mm, 5 1/8"
<b>OB513</b>	1.5 + 1.6	5/6	130 mm, 5 1/8"
<b>OB514</b>	1.8 + 1.9	7/8	130 mm, 5 1/8"

Eye Probes, malleable  
Stainless steel  
Augensonden, biegsam  
Edelstahl

WILDER

**OM486R**

Dilator for lacrymal duct  
Tränenkanal-Dilatator  
110 mm, 4 1/4"

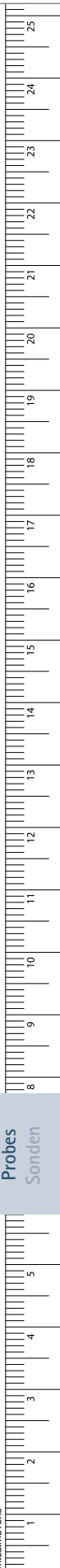

Probes  
Sonden

# Probes, Cotton Carriers, Redon Spikes – Sonden, Watteträger, Redon Spieße

## Tongue Spatulas, Cotton Carriers

### Zungenspatel, Watteträger

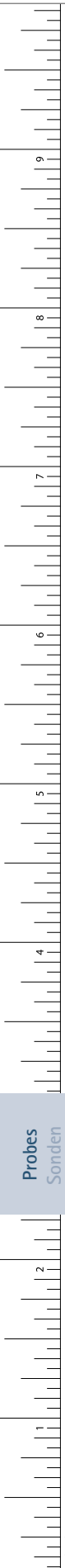

**BN184R**

Tongue spatula  
Zungenspatel  
145 mm, 5 3/4"



**OM202R**

Tongue spatula  
Zungenspatel  
145 mm, 5 3/4"

Diam. 0.7 mm  
Ø 0,7 mm

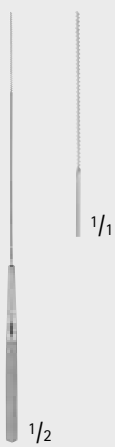

**MODELL PICCOLO**

**OF261R**

Cotton carrier,  
round serrated end  
Watteträger,  
rund gerieft  
110 mm, 4 1/4"

Diam. 0.7 mm  
Ø 0,7 mm

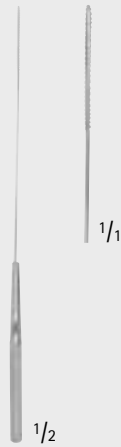

**MODELL PICCOLO**

**OF262R**

Cotton carrier,  
triangular serrated end  
Watteträger,  
dreikant gerieft  
110 mm, 4 1/4"

Diam. 1.2 mm  
Ø 1,2 mm



**FARRELL**

**OF257R**

Cotton carrier,  
round serrated end  
Watteträger,  
rund gerieft  
110 mm, 4 1/4"

Diam. 1.4 mm  
Ø 1,4 mm



**LATHBURY-FARRELL**

**OF259R**

Cotton carrier,  
triangular serrated end  
Watteträger,  
dreikant gerieft  
110 mm, 4 1/4"

# Probes, Cotton Carriers, Redon Spikes – Sonden, Watteträger, Redon Spieße

## Cotton Carriers

## Watteträger

Diam. 0.9 mm  
Ø 0,9 mm

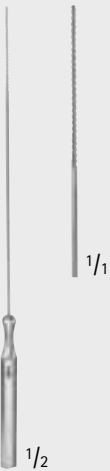

BUCK

**BN400R**

rough, spiral end  
spiralförmig gerieft  
120 mm, 4 3/4"

Diam. 0.9 mm  
Ø 0,9 mm



LATHBURY-FARRELL

**BN467R**

triangular serrated end  
dreikant gerieft  
140 mm, 5 1/2"



KING'S COLLEGE HOSPITAL

**BN403**

rough, spiral end  
spiralförmig gerieft  
90 mm, 3 1/2"



KING'S COLLEGE HOSPITAL

**BN404**

rough, spiral end  
spiralförmig gerieft  
135 mm, 5 1/4"

Diam. 1.0 mm  
Ø 1,0 mm



**BN440R**

rough, spiral end  
spiralförmig gerieft  
140 mm, 5 1/2"

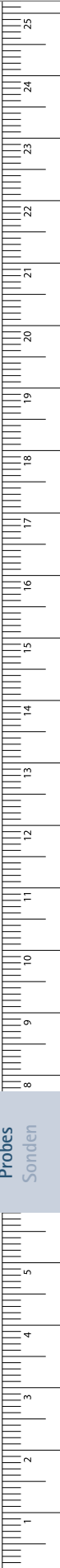

# Probes, Cotton Carriers, Redon Spikes – Sonden, Watteträger, Redon Spieße

## Cotton Carriers

## Watteträger



Diam. 1.2 mm  
Ø 1,2 mm

1/1

1/2

**FARRELL**  
**BN460R**  
round serrated end  
rund gerieft  
140 mm, 5 1/2"

Diam. 1.4 mm  
Ø 1,4 mm

1/1

1/2

**LATHBURY-FARRELL**  
**BN465R**  
triangular serrated end  
dreikant gerieft  
140 mm, 5 1/2"

Diam. 1.2 mm  
Ø 1,2 mm

1/1

1/2

**FARRELL**  
**BN461R**  
rough, spiral end  
spiralförmig gerieft  
160 mm, 6 1/4"

Diam. 1.2 mm  
Ø 1,2 mm

1/1

1/2

**LATHBURY-FARRELL**  
**BN466R**  
triangular serrated end  
dreikant gerieft  
160 mm, 6 1/4"

Diam. 1.5 mm  
Ø 1,5 mm

1/1

1/2

**FARRELL**  
**BN452R**  
rough, spiral end  
spiralförmig gerieft  
180 mm, 7"

Diam. 1.8 mm  
Ø 1,8 mm

1/1

1/2

**FARRELL**  
**BN457R**  
rough, spiral end  
spiralförmig gerieft  
180 mm, 7"

Probes  
Sonden



Probes, Cotton Carriers, Redon Spikes – Sonden, Watteträger, Redon Spieße

Redon Spikes

Redon Spieße



Art. No. Art. Nr.	Charr. Charr.
BN902R	8
BN903R	10
BN904R	12
BN905R	14
BN906R	16
BN907R	18
with thread mit Gewindeanschluss 190 mm, 7 1/2"	



Art. No. Art. Nr.	Charr. Charr.
BN912R	8
BN913R	10
BN914R	12
BN915R	14
BN916R	16
BN917R	18
with thread mit Gewindeanschluss 190 mm, 7 1/2"	



Art. No. Art. Nr.	Charr. Charr.
BN922R	8
BN923R	10
BN924R	12
BN925R	14
BN926R	16
with thread mit Gewindeanschluss 190 mm, 7 1/2"	



Art. No. Art. Nr.	Charr. Charr.
BN942R	8
BN943R	10
BN944R	12
BN945R	14
BN946R	16
BN947R	18
with thread mit Gewindeanschluss 190 mm, 7 1/2"	

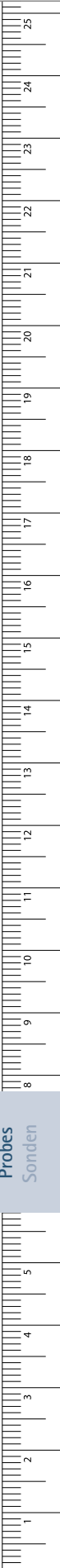

# Probes, Cotton Carriers, Redon Spikes – Sonden, Watteträger, Redon Spieße

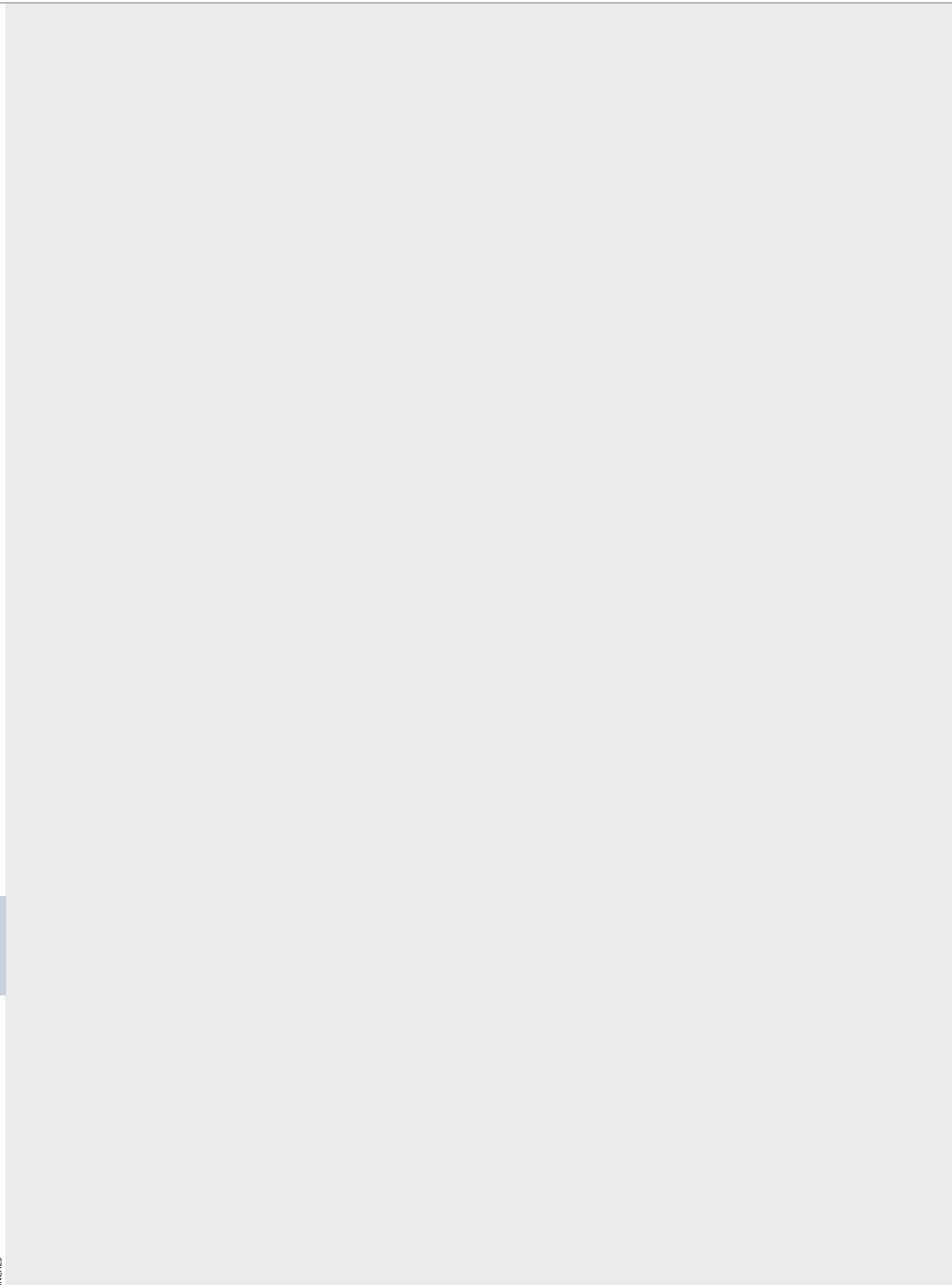

## General Surgical Instruments Chirurgische Instrumente

- Suction Instruments
- Sauginstrumente

# Suction Instruments, Syringes – Sauginstrumente, Spritzen

## Suction Cannulas

### Saugkanülen

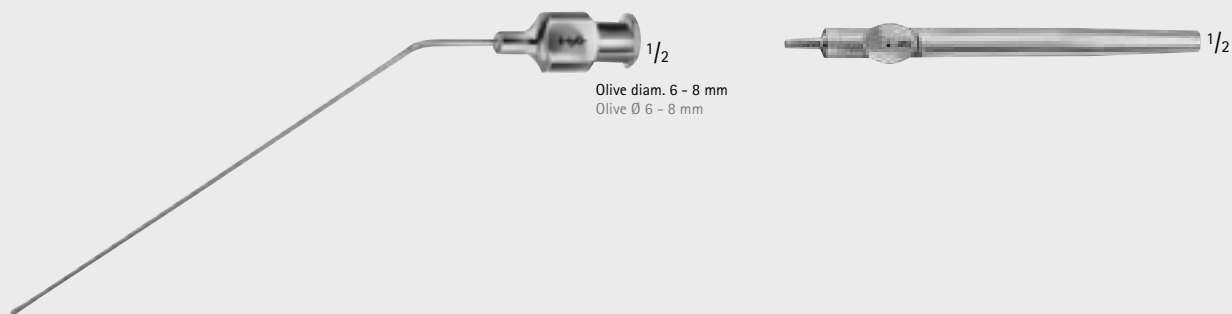

PLESTER

#### OG970R

**Suction set, complete, consisting of:**

- OG971R 1 Suction handle with finger cut-off, with LUER cone
- OG972R 2 Suction cannulas, diam. 0.5 mm, with LUER cone
- OG973R 2 Suction cannulas, diam. 0.7 mm, with LUER cone
- OG974R 2 Suction cannulas, diam. 1.0 mm, with LUER cone
- OG969R 2 Suction cannulas, diam. 1.3 mm, with LUER cone

not included:

- OG982R 2 Suction cannulas, diam. 1.5 mm, with LUER cone
- OG983R 2 Suction cannulas, diam. 2.0 mm, with LUER cone
- OG984R 2 Suction cannulas, diam. 2.5 mm, with LUER cone

Saugset komplett, bestehend aus:

- OG971R 1 Saughandgriff mit Unterbrecher, mit LUER-Konus
- OG972R 2 Saugkanülen, Ø 0,5 mm, mit LUER-Konus
- OG973R 2 Saugkanülen, Ø 0,7 mm, mit LUER-Konus
- OG974R 2 Saugkanülen, Ø 1,0 mm, mit LUER-Konus
- OG969R 2 Saugkanülen, Ø 1,3 mm, mit LUER-Konus

nicht im Set enthalten:

- OG982R 2 Saugkanülen, Ø 1,5 mm, mit LUER-Konus
- OG983R 2 Saugkanülen, Ø 2,0 mm, mit LUER-Konus
- OG984R 2 Saugkanülen, Ø 2,5 mm, mit LUER-Konus

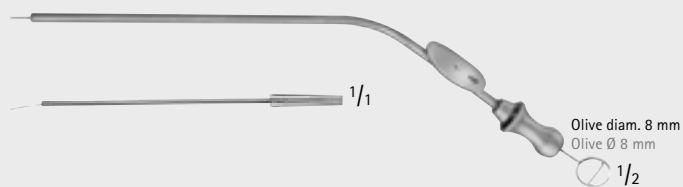

BELLUCCI

#### OG950R

**Suction set, complete, consisting of:**

- OG951R Suction tube with finger cut-off and stylet, 155 mm, 6 1/8"
- GF774R Detachable end, 24 swg. diam., 0.5 mm diam.
- GF773R Detachable end, 22 swg. diam., 0.7 mm diam.
- GF772R Detachable end, 20 swg. diam., 1.0 mm diam.

Saugset komplett, bestehend aus:

- OG951R Saugrohr, allein, mit Saugunterbrecher und Mandrin, 155 mm, 6 1/8"
- GF774R Saugkanüle, Ø 24 swg., Ø 0,5 mm
- GF773R Saugkanüle, Ø 22 swg., Ø 0,7 mm
- GF772R Saugkanüle, Ø 20 swg., Ø 1,0 mm

## Suction Instruments, Syringes – Sauginstrumente, Spritzen

## Suction Cannulas

## Saugkanülen



## ZOELLNER

Art. No. Art. Nr.	Diam. (swg) Ø (swg)	Diam. (mm) Ø (mm)	Length Länge
GF771R	18	1.2	55 mm, 2 1/4"
GF772R	20	1.0	55 mm, 2 1/4"
GF773R	22	0.7	55 mm, 2 1/4"
GF774R	24	0.5	55 mm, 2 1/4"
GF775R	26	0.4	55 mm, 2 1/4"

detachable tips, fitting GF770R and OG951R

Sales unit:

PAK = Package of 10 pieces

auswechselbare Spitzen zu GF770R und OG951R

Bestelleinheit:

PAK = Packung à 10 Stück



## VERHOEVEN

Art. No. Art. Nr.	Diam. (swg) Ø (swg)	Diam. (mm) Ø (mm)	Length Länge
GF763R	16	1.5	100 mm, 4"
GF764R	18	1.2	100 mm, 4"
GF765R	20	1.0	100 mm, 4"
GF766R	22	0.7	100 mm, 4"
GF767R	24	0.5	100 mm, 4"

Suction cannulas with LUER cone

Saugkanülen mit LUER-Konus

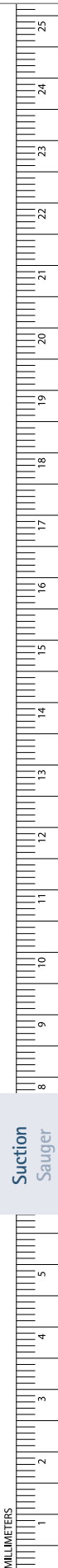

Suction  
Sauger

MILLIMETERS

## Suction Instruments, Syringes – Sauginstrumente, Spritzen

### Suction Adapter, Suction Cannula

### Saugadapter, Saugkanüle



Olive diam. 7 mm  
Olive Ø 7 mm

HOUSE

#### GF768R

Suction adapter with finger cut-off,  
LUER cone / LUER hub

Saugadapter mit Saugunterbrecher,  
LUER-Konus / LUER-Bohrung  
55 mm, 2 1/4"

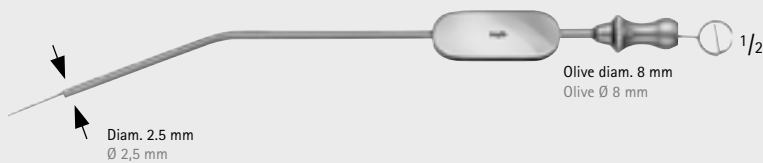

Diam. 2.5 mm  
Ø 2,5 mm

Olive diam. 8 mm  
Olive Ø 8 mm

ZOELLNER

#### GF770R

Suction cannula, only, with stylet  
fitting to the detachable ends GF771R and GF775R

Saugkanüle allein, mit Mandrin,  
passend zu den Saugkanülen GF771R und GF775R  
180 mm, 7"

Suction  
Sauger

# Suction Instruments, Syringes – Sauginstrumente, Spritzen

## Suction Cannulas

### Saugkanülen

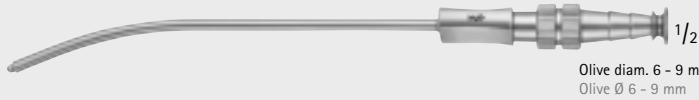

GILLIES

Art. No.	Diam. (mm)	Length
Art. Nr.	Ø (mm)	Länge

**OL187R** 3.0 170 mm, 6 3/4"

with finger cut-off and stylet  
mit Saugunterbrecher und Mandrin



ADSON

**GF917R**

with finger cut-off  
mit Saugunterbrecher  
190 mm, 7 1/2"



ADSON

**GF918R**

with finger cut-off and stylet  
mit Saugunterbrecher und Mandrin  
165 mm, 6 1/2"

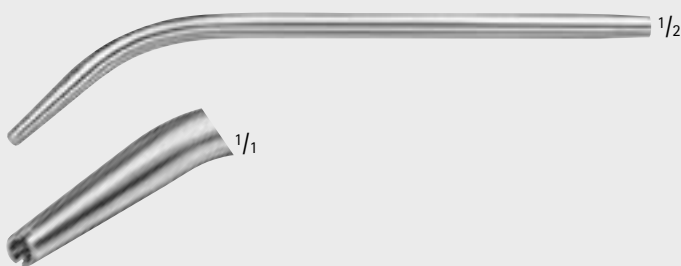

Art. No.	Diam. (mm)	Length	Art. No.	Diam. (mm)	Length
Art. Nr.	Ø (mm)	Länge	Art. Nr.	Ø (mm)	Länge
<b>DF771R</b>	2	140 mm, 5 1/2"	<b>DF781R</b>	2	170 mm, 6 3/4"
<b>DF773R</b>	3	140 mm, 5 1/2"	<b>DF783R</b>	3	170 mm, 6 3/4"
<b>DF774R</b>	4	140 mm, 5 1/2"	<b>DF784R</b>	4	170 mm, 6 3/4"
<b>DF775R</b>	5	140 mm, 5 1/2"	<b>DF785R</b>	5	170 mm, 6 3/4"

with notch at the working end to prevent premature suction  
mit Einkerbung am Arbeitsende, zur Vermeidung des vorschnellen Festsaugens

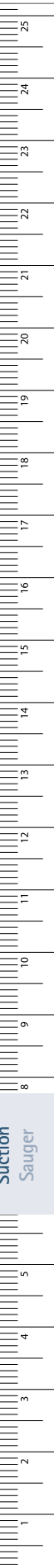

Suction  
Sauger

# Suction Instruments, Syringes – Sauginstrumente, Spritzen

## Suction Cannulas

### Saugkanülen

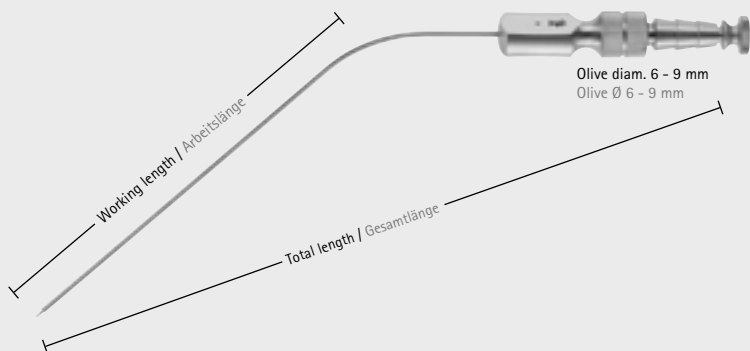

#### FERGUSSON

	Working length Arbeitslänge	110 mm, 4 1/4"	130 mm, 5 1/8"	160 mm, 6 1/4"	200 mm, 7 7/8"
	Total length Gesamtlänge	195 mm, 7 3/4"	215 mm, 8 1/2"	245 mm, 9 5/8"	280 mm, 11"
1.5 mm		GF350R	GF360R	GF370R	GF380R
2.0 mm		GF351R	GF361R	GF371R	GF381R
2.5 mm		GF352R	GF362R	GF372R	GF382R
3.0 mm		GF353R	GF363R	GF373R	GF383R
4.0 mm		GF354R	GF364R	GF374R	GF384R
5.0 mm		GF355R	GF365R	GF375R	GF385R

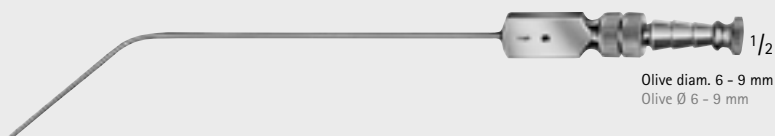

#### PLESTER

Art. No. Art. Nr.	Diam. (mm) Ø (mm)	Length Länge
GF939R	1.5	195 mm, 7 3/4"
GF940R	2.0	195 mm, 7 3/4"
GF941R	2.5	195 mm, 7 3/4"
GF942R	3.0	195 mm, 7 3/4"

with finger cut-off and stylet, thumb piece parallel to curve,  
with LUER hub  
mit Saugunterbrecher und Mandrin, Griffplatte parallel zur Biegung,  
LUER-Bohrung



# Suction Instruments, Syringes – Sauginstrumente, Spritzen

## Suction Cannulas

### Saugkanülen

#### Fukushima Design

- Teardrop shaped thumb control for a very precise suction regulation
- Malleable material for individual forming of the suction hose
- Conical design of the tube prevents plugging
- Comprehensive product program: 4 lengths and 9 diameters from 3 to 12 French (3 Fr. = 1 mm)
- Delivered with stylet

#### Fukushima Design

- Tropfenförmiger Saugunterbrecher für eine sehr feine Regulierung der Saugleistung
- Biցsames Material für individuelle Ausformung des Saugrohrs
- Konisches Design des Saugrohrs vermindert Verstopfung
- Umfassendes Produktprogramm: 4 Längen und 9 Durchmesser von 3 bis 12 French (3 Fr. = 1 mm)
- Saugkanüle wird mit Mandrin zur Reinigung geliefert

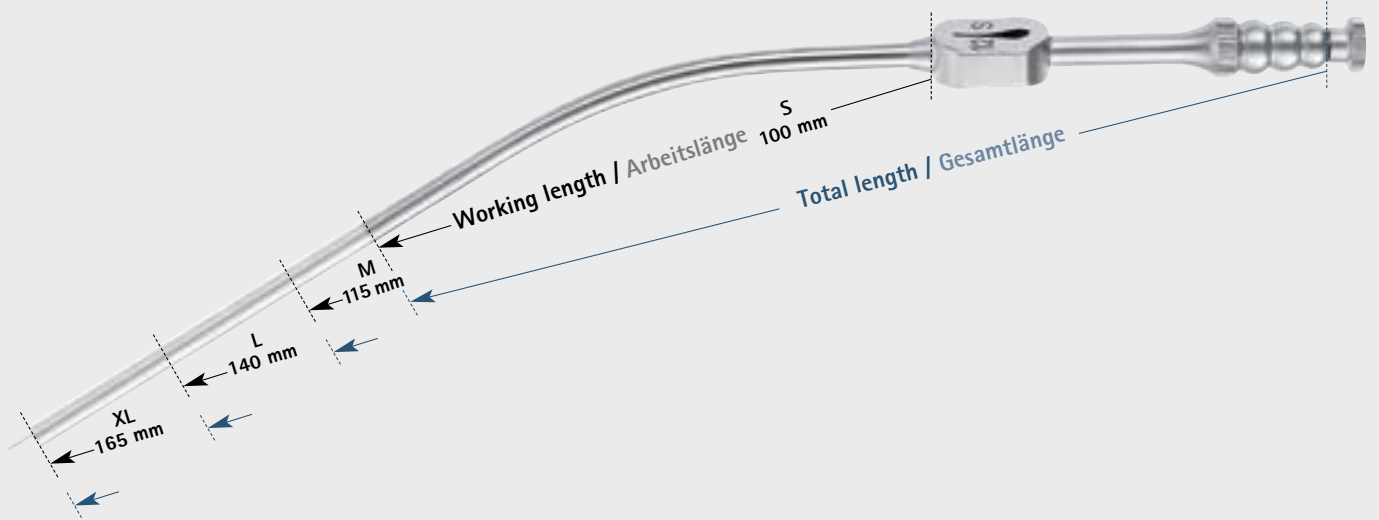

	S	M	L	XL
<b>Working length</b> Arbeitslänge	100 mm, 4"	115 mm, 4 1/2"	140 mm, 5 1/2"	165 mm, 6 1/2"
<b>Total length</b> Gesamtlänge	165 mm, 6 1/2"	180 mm, 7"	205 mm, 8"	230 mm, 9"

Outer diameter / Außendurchmesser	3 Fr.	○	GF401R	GF391R	GF411R	GF421R
	4 Fr.	○	GF402R	GF392R	GF412R	GF422R
	5 Fr.	○	GF403R	GF393R	GF413R	GF423R
	6 Fr.	○	GF404R	GF394R	GF414R	GF424R
	7 Fr.	○	GF405R	GF395R	GF415R	GF425R
	8 Fr.	○	GF406R	GF396R	GF416R	GF426R
	9 Fr.	○	GF407R	GF397R	GF417R	GF427R
	10 Fr.	○	GF408R	GF398R	GF418R	GF428R
	12 Fr.	○	GF409R	GF399R	GF419R	GF429R

3 Fr. = 1 mm

- For further details about suction cannulas, Fukushima Style, see brochure no. C81202.
- Weitere Informationen über Saugkanülen, Fukushima Style, finden Sie im Prospekt Nr. C81202.

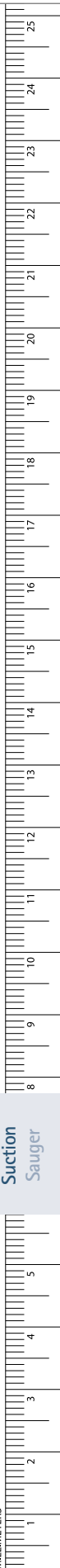

# Suction Instruments, Syringes – Sauginstrumente, Spritzen

## Suction Cannulas

### Saugkanülen

#### RAABE micro suction

- Fine micro suction instruments
- Rigid instrument, ideal for precise preparations
- Atraumatic instrument tip
- Wider view of the operating site even for the narrowest of approaches
- Ring-coded length, available in:
  - 80 mm (1 ring)
  - 100 mm (2 rings)
  - 120 mm (3 rings)
  - 140 mm (4 rings)
- Color-coded width, available in:
  - 4 FR (yellow)
  - 6 FR (blue)
  - 8 FR (green)

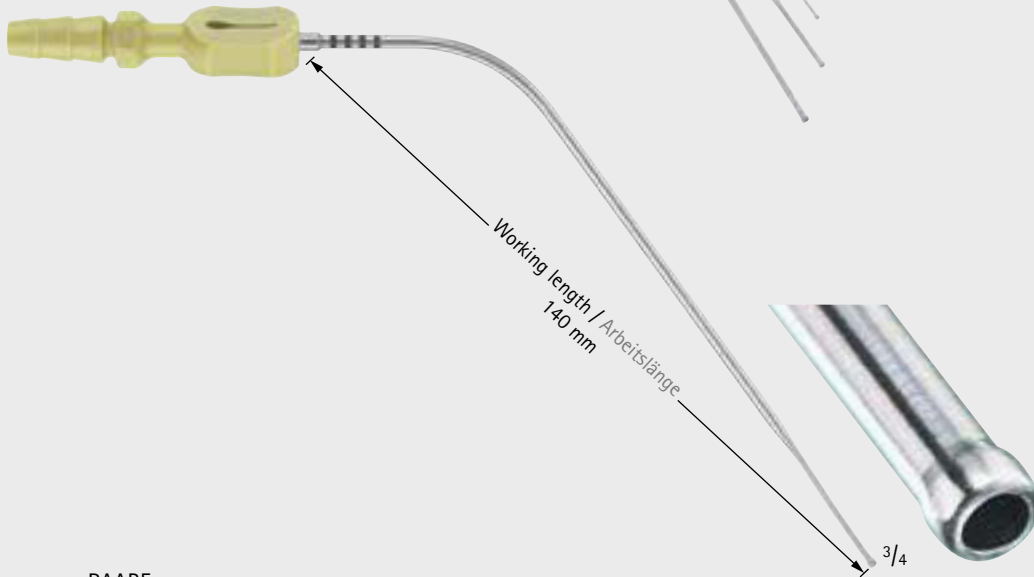
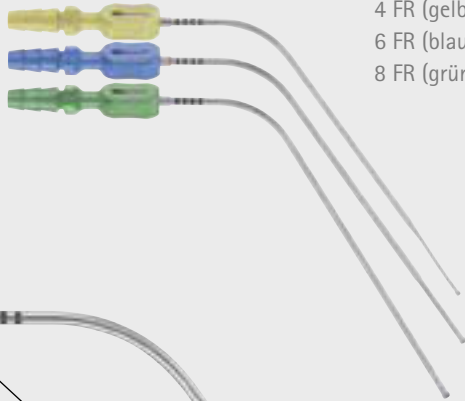
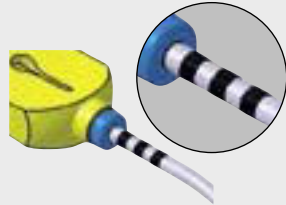

#### Mikro-Sauger nach RAABE

- Feine Mikro-Sauger
- Biegesteifes Instrument ideal für präzise Präparationen
- Atraumatische Instrumentenspitze
- Erweiterte Übersicht im OP-Gebiet auch bei kleinsten Zugängen
- Kodierte Längen über Strichcode, verfügbar in:
  - 80 mm (1 Ring)
  - 100 mm (2 Ringe)
  - 120 mm (3 Ringe)
  - 140 mm (4 Ringe)
- Kodierte Breite, verfügbar in:
  - 4 FR (gelb)
  - 6 FR (blau)
  - 8 FR (grün)

RAABE

RAABE		○S	○○M	○○○L	○○○○XL
<b>Working length</b> Arbeitslänge		80 mm, 3 1/8"	100 mm, 4"	120 mm, 4 3/4"	140 mm, 5 1/2"
<b>Total length</b> Gesamtlänge		130 mm, 5 1/8"	150 mm, 6"	165 mm, 6 1/2"	185 mm, 7 1/4"
<b>Outer diameter /</b> Außendurchmesser					
4 Fr. yellow / gelb	○	GF470R	GF473R	GF476R	GF479R
6 Fr. blue / blau	◎	GF471R	GF474R	GF477R	GF480R
8 Fr. green / grün	⊙	GF472R	GF475R	GF478R	GF481R

3 Fr. = 1 mm

- For further details about RAABE micro suction see brochure no. C24602.
- Weitere Informationen über Mikro-Sauger nach RAABE finden Sie im Prospekt Nr. C24601.

## Suction Instruments, Syringes – Sauginstrumente, Spritzen

## Suction Cannulas

## Saugkanülen

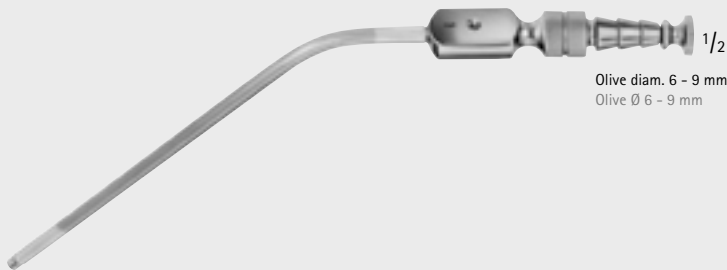

## FERGUSSON

Art. No.	Diam. (mm)	Length
Art. Nr.	Ø (mm)	Länge
<b>GF933R</b>	4.0 mm	180 mm, 7"

insulated, with finger cut-off and stylet, thumb piece 90° to curve,  
with LUER hub

isoliert, mit Saugunterbrecher und Mandrin, Griffplatte 90° zur Biegung,  
LUER-Bohrung



## FRAZIER

Art. No.	Diam. (mm)	Length
Art. Nr.	Ø (mm)	Länge
<b>GF923R</b>	3.0 mm	180 mm, 7"
<b>GF925R</b>	5.0 mm	180 mm, 7"

with finger cut-off and stylet, thumb piece 90° to curve,  
with LUER hub

mit Saugunterbrecher und Mandrin, Griffplatte 90° zur Biegung,  
LUER-Bohrung

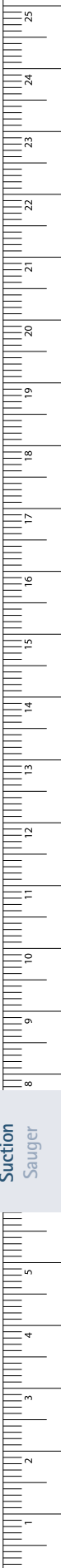

## Suction Instruments, Syringes – Sauginstrumente, Spritzen

## Suction Cannulas

## Saugkanülen



## FRAZIER

Art. No. Art. Nr.	Diam. (mm) Ø (mm)	Working length Arbeitslänge
MD124R	2.3	110 mm, 4 1/4"
MD125R	2.7	110 mm, 4 1/4"
MD127R	3.4	110 mm, 4 1/4"
MD129R	4.0	110 mm, 4 1/4"
MD130R	5.0	110 mm, 4 1/4"

Suction cannula with finger cut-off and stylet, thumb piece 90° to curve, with LUER hub  
Saugkanüle mit Saugunterbrecher und Mandrin, Griffplatte 90° zur Biegung, LUER-Bohrung

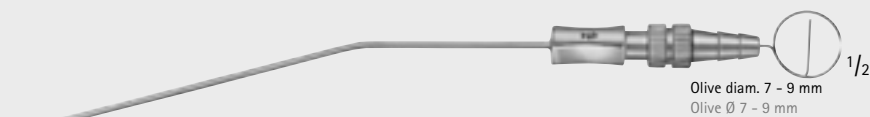

## LEMPERT

Art. No. Art. Nr.	Diam. (mm) Ø (mm)	Length Länge
GF937R	2.0	200 mm, 7 7/8"
GF938R	3.0	200 mm, 7 7/8"

with finger cut-off and stylet  
mit Saugunterbrecher und Mandrin



## FORMBY

Art. No. Art. Nr.	Diam. (mm) Ø (mm)	Length Länge
GF932R	3.3	210 mm, 8 1/4"

## Suction Instruments, Syringes – Sauginstrumente, Spritzen

## Suction Cannulas

## Saugkanülen



## BARRON

Art. No.	Diam. (mm)	Length
Art. Nr.	Ø (mm)	Länge

GF935R	1.3	160 mm, 6 1/4"
--------	-----	----------------

GF936R	2.0	160 mm, 6 1/4"
--------	-----	----------------

with finger cut-off and stylet

mit Saugunterbrecher und Mandrin



## SCHUHKNECHT

Art. No.	Diam. (swg)	Diam. (mm)	Length
Art. Nr.	Ø (swg)	Ø (mm)	Länge

GF756R	20	1.0	130 mm, 5 1/8"
--------	----	-----	----------------

GF757R	24	0.5	130 mm, 5 1/8"
--------	----	-----	----------------

Suction cannula

Saugkanüle



Art. No.	Diam. (mm)	Tip size (mm)	Length
Art. Nr.	Ø (mm)	Spitzenbreite (mm)	Länge

GF919R	5.0	6.5	180 mm, 7"
--------	-----	-----	------------

Nasal suction tube, with LUER hub

Nasensaugrohr, LUER-Bohrung

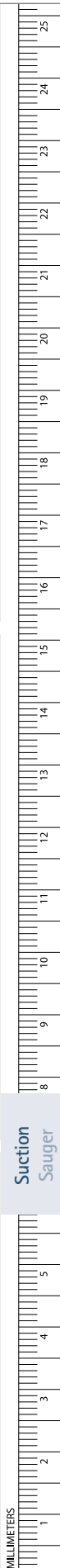

# Suction Instruments, Syringes – Sauginstrumente, Spritzen

## Suction Cannulas

### Saugkanülen



MAGILL

Art. No. Art. Nr.	Diam. (mm) Ø (mm)	Length Länge
GF906R	3.0	245 mm, 9 5/8"
GF907R	3.5	245 mm, 9 5/8"
GF908R	4.0	245 mm, 9 5/8"

**GF909R**

Styler for MAGILL suction tubes

Reinigungsdraht zu MAGILL-Saugkanülen



ROWBOTHAM

**OM672R**

with styler

mit Mandrin

295 mm, 11 5/8"



Olive diam. 9 mm  
Olive Ø 9 mm



Diam. 5 mm  
Ø 5 mm

DE BAKEY

**GF947R**

with finger cut-off and styler

mit Saugunterbrecher und Mandrin

160 mm, 6 1/4"

# Suction Instruments, Syringes - Sauginstrumente, Spritzen

## Suction Cannulas

### Saugkanülen



Diam. 9 mm  
Ø 9 mm

DE BAKEY

**GF946R**

275 mm, 10 3/4"

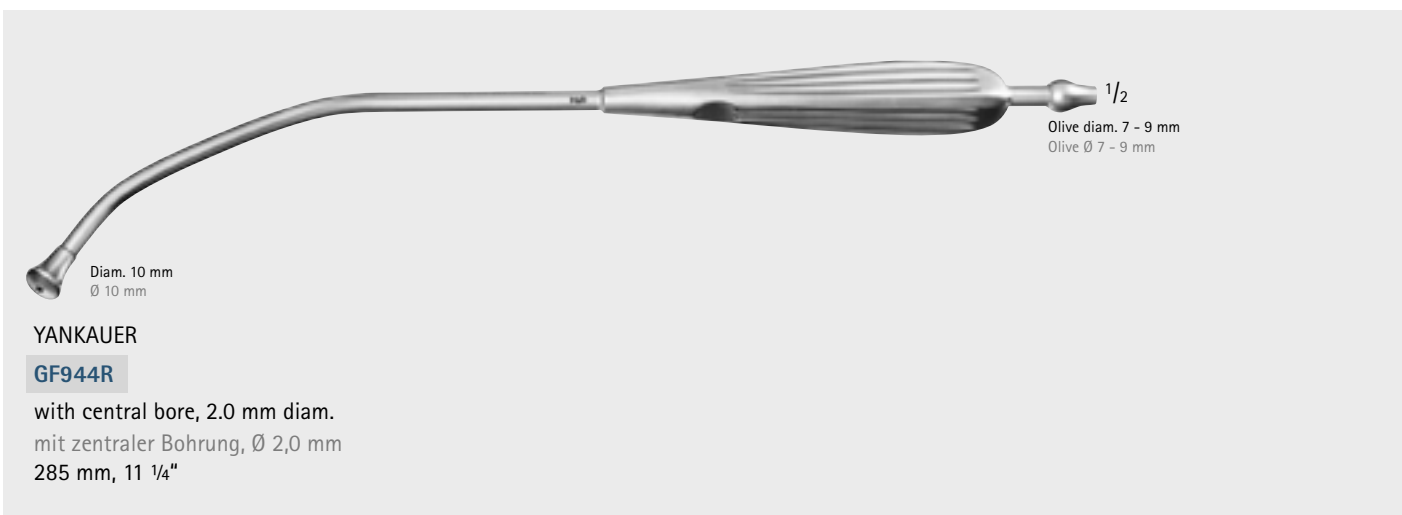

Diam. 10 mm  
Ø 10 mm

1/2  
Olive diam. 7 - 9 mm  
Olive Ø 7 - 9 mm

YANKAUER

**GF944R**

with central bore, 2.0 mm diam.  
mit zentraler Bohrung, Ø 2,0 mm  
285 mm, 11 1/4"

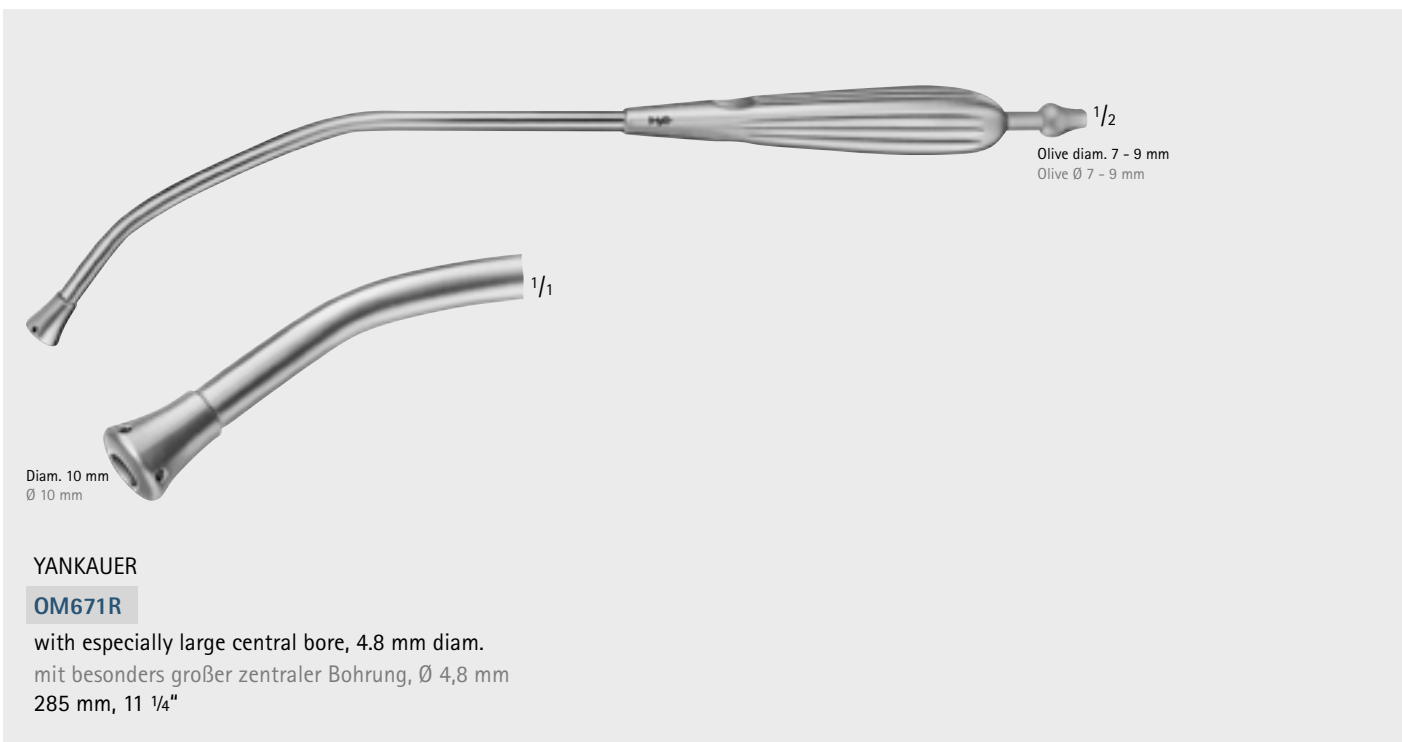

Diam. 10 mm  
Ø 10 mm

1/2  
Olive diam. 7 - 9 mm  
Olive Ø 7 - 9 mm

YANKAUER

**OM671R**

with especially large central bore, 4.8 mm diam.  
mit besonders großer zentraler Bohrung, Ø 4,8 mm  
285 mm, 11 1/4"

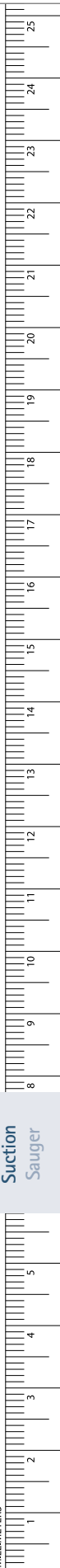

Suction  
Sauger

# Suction Instruments, Syringes – Sauginstrumente, Spritzen

## Suction Cannulas

### Saugkanülen



Diam. 3.5 mm  
Ø 3,5 mm

Diam. 2.0 mm  
Ø 2,0 mm

Olive diam. 6 - 9 mm  
Olive Ø 6 - 9 mm

Art. No. Art. Nr.	Working length Arbeitslänge
<b>OP030R</b>	500 mm, 19 3/4"
<b>OP031R</b>	350 mm, 13 3/4"

with rubber tip, with LUER hub  
mit Gummispitze, mit LUER-Bohrung

250 mm, 9 3/4"

Art. No. Art. Nr.	Diam. (mm) Ø (mm)	Working length Arbeitslänge
<b>OP360R</b>	2.0	250 mm, 9 3/4"
<b>OP361R</b>	2.5	250 mm, 9 3/4"
<b>OP362R</b>	3.0	250 mm, 9 3/4"

Olive diam. 6 - 9 mm  
Olive Ø 6 - 9 mm

Olive diam. 6 mm  
Olive Ø 6 mm

**NEGUS**  
**OL177R**  
Suction dissector  
Saugdissektor  
210 mm, 8 1/4"

Olive diam. 6 - 10 mm  
Olive Ø 6 - 10 mm

**GORNEY**  
**OL168R**  
Suction dissector  
Saugdissektor  
180 mm, 7"



## Suction Instruments, Syringes – Sauginstrumente, Spritzen

Suction Raspatories, Dissecting Suction Tube, Tonsil Dissector

Saugraspatorien, Präpariersauger, Tonsillendissektor

Olive diam. 6 - 9 mm  
Olive Ø 6 - 9 mm

Art. No.	Diam. (mm)	Length
Art. Nr.	Ø (mm)	Länge
<b>OL195R</b>	4	200 mm, 7 7/8"
<b>OL196R</b>	5	200 mm, 7 7/8"

Suction raspatory sharp, bayonet-shaped, with stylet

Saugraspatorium, scharf, bajonettförmig gebogen, mit Mandarin

Olive diam. 6 - 9 mm  
Olive Ø 6 - 9 mm

LANDOLT

Art. No.	Diam. (mm)	Length
Art. Nr.	Ø (mm)	Länge
<b>GF980R</b>	3.2	200 mm, 7 7/8"

Dissecting suction tube for hypophysectomy and ENT,  
sharp angled pointPräpariersauger für Hypophysektomie und HNO,  
winklige Spitze, scharfOlive diam. 9 mm  
Olive Ø 9 mm

LOPEZ-REINKE

**OM670R**

Tonsil dissector with suction device

Tonsillendissektor mit Absaugvorrichtung

235 mm, 9 1/4"

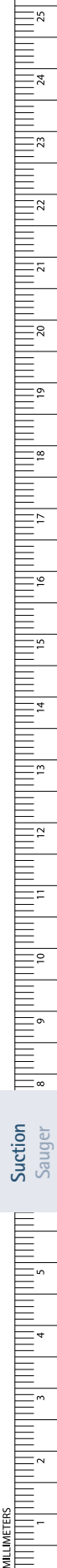
Suction  
Sauger

MILLIMETERS

# Suction Instruments, Syringes – Sauginstrumente, Spritzen

## Suction Cannulas

### Saugkanülen



#### HOUSE

Art. No. Art. Nr.	Diam. (mm) suction tube Ø (mm) Saugrohr	Diam. (mm) irrigation tube Ø (mm) Spülrohr
GF911R	0.9	0.7
GF912R	1.2	0.9
GF913R	1.5	1.2

with finger cut-off and stylet, with LUER hub  
mit Saugunterbrecher und Mandrin, LUER-Bohrung

## Suction Instruments, Syringes – Sauginstrumente, Spritzen

Syringes, Tonsil and Septum Needles, Injection Needles

Spritzen, Tonsillen- und Septumnadeln, Injektionsnadel

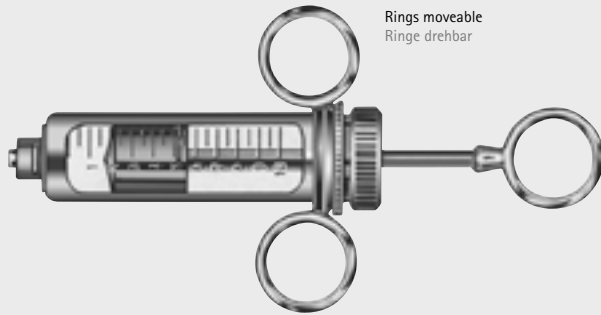

Art. No. Art. Nr.	Content Inhalt
----------------------	-------------------

SP333 5 ml

SP336 10 ml

Syringe, complete  
Spritze, komplett

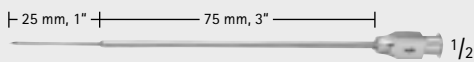

### SF811R

Tonsil needle, straight  
with LUER-LOCK attachment  
Tonsillenkanüle, gerade  
mit LUER-LOCK-Ansatz

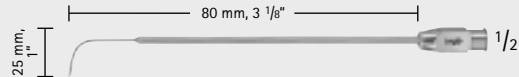

### SF813R

Tonsil needle, strongly curved  
with LUER-LOCK attachment  
Tonsillenkanüle, stark gebogen  
mit LUER-LOCK-Ansatz

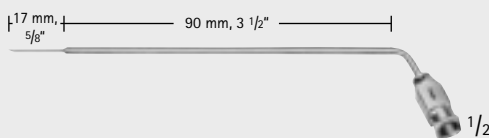

### SF812R

Septum needle, angled  
with LUER-LOCK attachment  
Septumkanüle, abgewinkelt  
mit LUER-LOCK-Ansatz

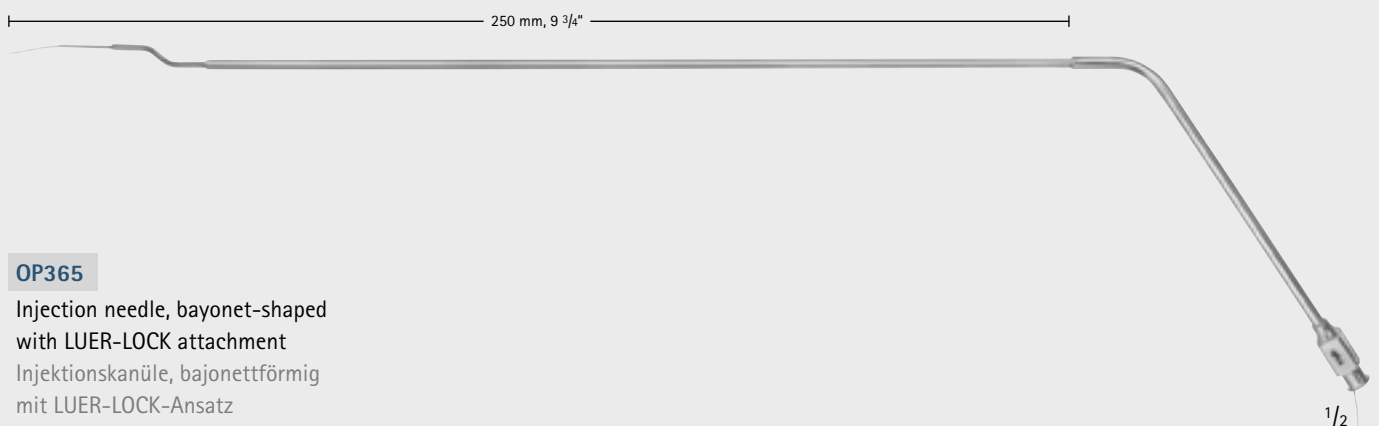

### OP365

Injection needle, bayonet-shaped  
with LUER-LOCK attachment  
Injektionskanüle, bajonettförmig  
mit LUER-LOCK-Ansatz

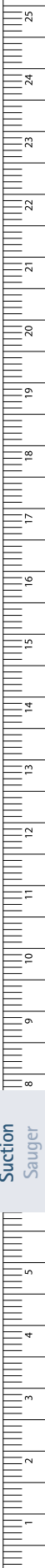

Suction  
Sauger

# Suction Instruments, Syringes – Sauginstrumente, Spritzen

## Syringes, Needle Attachment

### Spritzen, Kanülenkopf

- Aesculap Cartridge Syringe "Aspira-plus II" made of stainless instrument-steel, with aspiration device. After having inserted the ampulla and the cannula the syringe is immediately ready for injection. By a slight twist of the piston rod to the right the double corkscrew tip will grasp the foam rubber of the ampulla. This enables a safe and controlled aspiration.



#### Advantages:

- Easy and safer processing by using corrosion- and acid resistant instrument steel instead of chrome material
- Easy cartridge insert and ejection by folding back the bush
- Enables controlled and safe aspiration



- Aesculap Zylinderampullenspritze "Aspira-plus II" aus rostfreiem Instrumentenstahl, mit Aspirationsvorrichtung. Nach Einschieben der Ampulle und Aufsetzen der Kanüle ist die Spritze injektionsbereit. Durch leichtes Rechtsdrehen der Kolbenstange erfasst die Doppelkorkenzieherspitze den Moosgummikolben der Ampulle. Dadurch wird eine sichere und zuverlässige Aspiration ermöglicht.

#### Vorteile:

- Einfache und sichere Aufbereitung durch Verwendung von rost- und säurebeständigem Instrumentenstahl anstelle von verchromten Material
- Umklappbare Hülse für leichtes Einführen und Auswerfen der Ampulle
- Kontrolliertes und sicheres Aspirieren



Art. No.	Content
Art. Nr.	Inhalt
SL018R	1.8 ml
SL022R	2.2 ml

Syringe with long needle (SL002R)  
Spritze mit langem Kanülenkopf (SL002R)



Art. No.	Content
Art. Nr.	Inhalt
SL118R	1.8 ml

SL122R 2.2 ml  
Syringe with crutch handle, with long needle attachment (SL002R)  
Spritze mit Krückengriff, mit langem Kanülenkopf (SL002R)



#### SL002R

Needle attachment, long, suitable for all disposable needles with a thread diameter of 6 mm and long cartridge pick (e.g. Sterican®Z, B. Braun etc.)  
Kanülenkopf, lang, geeignet für alle Einmalkanülen mit einem Gewinde-Ø von 6 mm und langer Ampullen-Einstichkanüle (z. B. Sterican®Z, B. Braun etc.)

Suction Sauger

INCHES

## Suction Instruments, Syringes – Sauginstrumente, Spritzen

### Syringes, Needle Attachment

### Spritzen, Kanülenkopf

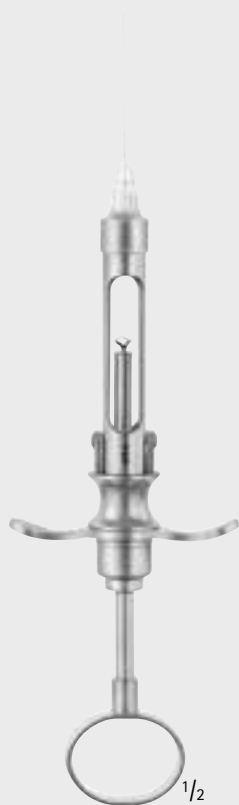

Art. No.	Content
Art. Nr.	Inhalt

SL028R	1.8 ml
--------	--------

SL032R	2.2 ml
--------	--------

Syringe with short needle attachment (SL033R)  
Spritze mit kurzem Kanülenkopf (SL033R)



**SL033R**

Short needle attachment only, for American disposable needles with small thread (5.5 mm diam.) and short cartridge pick  
Kurzer Kanülenkopf allein, für amerikanische Einmalkanülen mit kleinem Gewinde (Ø 5,5 mm) und kurzer Ampullen-Einstichkanüle



Art. No.	Content
Art. Nr.	Inhalt

SL017R	1.8 ml
--------	--------

Syringe without needle attachment  
Spritze ohne Kanülenkopf



**SL034R**

Short needle attachment only, for disposable needles, with large thread (6 mm diam.) and short cartridge pick  
Kurzer Kanülenkopf allein, für Einmalkanülen, mit großem Gewinde (Ø 6 mm) und kurzer Ampullen-Einstichkanüle

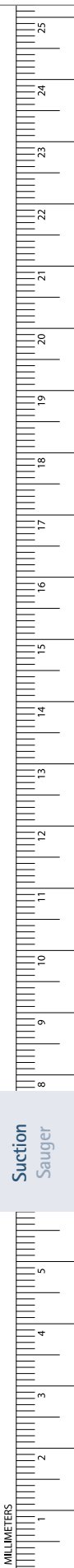

Suction  
Sauger



For further information about SUSI Single Use Surgical Instruments see brochure no. C82002.

Weitere Information über SUSI Einmalinstrumente finden Sie im Prospekt Nr. C82001.



For further information about Electrosurgical Instruments see brochure no. C30481.

Weitere Information über Elektrochirurgie Instrumente finden Sie im Prospekt Nr. C30481.



For further information about Power Systems see brochure no. O22702.

Weitere Information über Motorensysteme finden Sie im Prospekt Nr. O22701.



Reprocessing  
Aufbereitung



## Aesculap Sterile Technology.

### A worldwide leading manufacturer since decades

For more than 40 years, Aesculap is a leading manufacturer of sterile containers representing the sterile supplies packaging and the systematic organisation of the sterile supply cycle. In 1971, when Aesculap invented and presented the first genuine sterile container – based on research and development in which Aesculap had played a crucial role since the beginning of the 20th century – this marked the arrival of a world first. The revolutionary packing and supply system quickly proved itself and soon was established in Germany, Europe and the USA. During all this change, the patient has always been the paramount consideration: from preservation of the sterility of surgical instruments through transport and storage periods right to the operating table. Through their innovative technology, Aesculap sterile containers became an established part of the sterile supply cycle. By using Aesculap sterile containers, the entire cycle of supply and disposal of sterile materials can be standardised, controlled and documented: from sterile storage and transport, through easy setup in the operating room, to protected disposal of the used instruments. At the disposal stage, Aesculap sterile containers reliably protect hospital staff against contamination and thereby support hospital quality management systems with regard to hygiene and infection prophylaxis.



### Weltweit führender Anbieter seit Jahrzehnten

Seit mehr als 40 Jahren ist Aesculap führender Hersteller von Sterilcontainern für die Sterilgutverpackung zur systematischen Organisation des Sterilgutkreislaufes.

Mit der Erfindung und Bereitstellung des ersten echten Sterilcontainers schuf Aesculap 1971 ein weltweites Novum – basierend auf einer Forschungs- und Entwicklungsarbeit, die Aesculap bereits seit Anfang des 20. Jahrhunderts entscheidend mitgeprägt hat. Das damals revolutionäre Verpackungs- und Bereitstellungssystem bewährte sich schnell und setzte sich bald in Deutschland, Europa und den USA durch. Im Vordergrund der Bewertung stand dabei stets der Patient: Von der Sterilerhaltung der chirurgischen Instrumente während Transport und

Lagerdauer bis hin zum operativen Einsatz.

Ihre innovative Technologie sowie die komfortable Handhabung haben Aesculap Sterilcontainer zu einem festen Bestandteil der Sterilgutversorgung werden lassen. Durch die Verwendung der Sterilcontainer ist der gesamte Kreislauf der Sterilgutver- und entsorgung standardisierbar, kontrollierbar und dokumentierbar: dies gilt für die sterile Lagerung und den sterilen Transport ebenso wie für die einfache Bereitstellung im OP und die sichere Entsorgung der benutzten Instrumente. Bei der Entsorgung schützen Aesculap Sterilcontainer das Klinikpersonal zuverlässig vor Kontamination und unterstützen somit das Qualitätsmanagement der Klinik hinsichtlich Hygiene und Infektionsprophylaxe.



## Reprocessing, Care & Maintenance – Aufbereitung und Pflege



### Four good reasons to choose the Sterile Container System:

- Protection for patients and staff through preservation of instrument sterility and closed transport of used instruments
- Advantages due to reusable packaging, low costs of use and long service life
- Comfortable handling: simple, quick and reliable
- Transparency: standardised easy documentation of the supply cycle

### Vier gute Gründe für das Sterilcontainer System:

- Schutz für Patient und Personal durch Sterilerhaltung der Instrumente und geschlossenen Transport benutzter Instrumente
- Vorteile durch die Wiederverwendbarkeit der Verpackung, niedrige Gebrauchskosten und eine hohe Lebensdauer
- Komfortable Handhabung: einfach, schnell und verlässlich
- Übersichtlichkeit: standardisierbar, einfache Dokumentation des Warenkreislaufes

## Dedicated solutions for individual requirements

As a leading supplier of comprehensive sterile supply management systems worldwide, Aesculap can offer an extensive, clinically proven product portfolio for sterile packaging. The diversity of the Aesculap Sterile Container System offers packaging solutions for every instrument tray used in hospital practice. Containers in various variants and sizes and the comprehensive range of accessories make the Aesculap Sterile Container System a universal solution for the sterile supply of surgical instruments.

## Training, development

Aesculap is involved in the continuous improvement of sterile supply everywhere in the world, through training events held by the Aesculap Academy, contributions by Aesculap staff and collaborators at national and international conferences, and extensive consulting activities on site with the user. At the same time, the Aesculap Sterile Container System benefits from continuous development to meet new demands on the processing and sterilization of surgical instruments, be it by using new materials or by introducing intelligent germ barrier systems.

## Spezielle Lösungen für individuelle Ansprüche

Als ein weltweit führender Anbieter für das gesamte Sterilgutmanagement verfügt Aesculap über eine umfangreiche und praxisbewährte Produktpalette zur Sterilgutverpackung. Die Vielfalt des Aesculap Sterilcontainer Systems bietet Verpackungslösungen für alle in der Praxis verwendeten Instrumentensiebe des Krankenhauses. Container in verschiedenen Versionen und Größen sowie das umfangreiche Zubehör machen das Sterilcontainer System zu einer Universallösung für die Sterilgutversorgung mit chirurgischen Instrumenten.

## Weiterbildung, Weiterentwicklung

Aesculap engagiert sich weltweit für die kontinuierliche Verbesserung der Sterilgutversorgung durch Weiterbildungsveranstaltungen der Aesculap Akademie, durch Referententätigkeit von Aesculap Mitarbeitern bei nationalen und internationalen Kongressen sowie durch umfangreiche Beratungstätigkeiten beim Anwender selbst. Parallel wird das Aesculap Sterilcontainersystem beständig weiterentwickelt, um neuen Anforderungen der Aufbereitung und Sterilisation chirurgischer Instrumente gerecht zu werden, sei es durch die Verwendung neuer Materialien oder den Einsatz intelligenter Keimrückhaltesysteme.

## Think Competence. Think Aesculap.



### Knowledge exchange – our conviction

As a competent partner for the sterile materials supply in hospitals, Aesculap supports the specialist training and qualification of staff in central sterile supplies departments and operating rooms. This is achieved for instance by offering training events held by the Aesculap Academy all over the world and by sending specialist speakers to national and international conferences.

Active participation in national and international standards committees, professional associations and working groups provides a solid basis for the development of high-quality and reliable products, always in dialogue with the user community. This lively knowledge exchange between all parties is the hallmark of our philosophy: sharing expertise.

### Wissensaustausch aus Überzeugung

Als kompetenter Partner für die Sterilgutversorgung im Krankenhaus unterstützt Aesculap die Fachausbildung und Qualifizierung der Mitarbeiter in Zentralsterilisation und OP. Dies erfolgt unter anderem durch die weltweiten Schulungsangebote der Aesculap Akademie und eigene Fachreferenten bei nationalen und internationalen Kongressen. Die aktive Beteiligung an

nationalen und internationalen Normenausschüssen, Fachgesellschaften und Arbeitskreisen schafft eine solide Basis für die Entwicklung hochwertiger und sicherer Produkte im Dialog mit den Anwendern. Dieser rege Wissensaustausch zwischen allen Beteiligten steht ganz im Zeichen der Philosophie von Sharing Expertise.

### Competence in demand planning and tray optimization

At the project planning stage, the Aesculap planning team cooperates with surgical staff and sterile supplies specialists to adapt the configuration of required sterile containers, trays and organization aids to the existing instrument trays.

### Kompetenz in Bedarfsplanung und Sieboptimierung

Im Rahmen der Projektplanung durch das Aesculap Planungsteam wird in Zusammenarbeit mit dem Fachpersonal aus Operationsabteilung und Sterilgutversorgung die Zusammenstellung der benötigten Sterilcontainer, Siebkörbe und Organisationshilfen an bereits vorhandene Instrumentensiebe angepasst.

## Think Economy. Think Aesculap.

### Significant advantages over the entire system lifespan

All hospitals are obliged and challenged to apply process optimization to make hospital processes more efficient and cost-effective. At the same time, there remains the basic duty to consider quality standards to maintain legal security and patient safety.

With the Sterile Container System, Aesculap can provide a crucial contribution towards these objectives. In contrast to single-use packaging, sterile

containers are capital assets offering a long service life. We are convinced that in comparison to single-use packaging, despite of its higher acquisition costs, the Aesculap sterile container system offers the following advantages in the course of its long service life:

- No recurring costs for packaging materials
- Reduction or elimination of disposal costs for single-use materials
- Time savings during packaging process
- Time savings at the sterilization stage
- Reduced incidence of re-sterilization due to robust sterile packaging system
- Fast and easy aseptic presentation
- Easy transportation from and to the OR
- Long service life

### Wesentliche Vorteile – ein Leben lang

Prozessoptimierung mit dem Ziel, Abläufe im Krankenhaus effizienter und kostengünstiger zu gestalten, sind Aufgabe und Herausforderung für jede Klinik. Grundlegende Verpflichtung ist dabei die gleichzeitige Berücksichtigung von Qualitätsstandards unter den Aspekten der Rechts- und Patientensicherheit. Hierzu leistet Aesculap mit dem Sterilcontainer System einen wesentlichen Beitrag.

Im Gegensatz zu den Einmalverpackungen sind Sterilcontainer langlebige Wirtschaftsgüter. Wir sind überzeugt, dass im Vergleich zur Einmalverpackung das Aesculap Sterilcontainer System während seines langjährigen Einsatzes trotz seiner höheren Anschaffungskosten folgende Vorteile aufweist:

- Keine wiederkehrenden Kosten für Verpackungsmaterial
- Geringere/keine Entsorgungskosten für Einmalmaterial
- Geringerer Zeitaufwand beim Packen der Siebe
- Aufgrund der stabilen Verpackung des Sterilguts geringere Re-Sterilisationsraten wegen beschädigter Verpackungen
- Schnelle Sterilbereitstellung
- Einfacher Transport im Sterilkreislauf
- Hohe Lebensdauer der Sterilcontainer

**We will gladly provide a comparative calculation based on the specific conditions in your organization.**

Gerne stellen wir Ihnen eine Vergleichsrechnung basierend auf Ihre individuellen Verhältnisse zur Verfügung.



## Think Quality. Think Aesculap.

### Quality without compromise

More than 40 years of experience in sterile supplies provision have resulted in practical and user-friendly solutions. However, maintaining the sterility of surgical instruments has always been of paramount importance.

All components of the Aesculap Sterile Container System meet the requirements of national and international standards for sterile packaging, in particular:

- DIN EN ISO 11607
- DIN 58953, Part 9
- MDD 93/42/EWG

The robust design and state-of-the-art manufacturing methods of Aesculap ensure a reliability and consistency of the shape, dimensions and integrity of the sterile containers, instrument trays and other system components. This, and the use of high-grade materials in all components, ensures a long and virtually maintenance-free service life of our sterile containers.



### Qualität ohne Kompromisse

Mehr als 40 Jahre Erfahrung in der Sterilgutversorgung führen zu praxisnahen und anwenderfreundlichen Lösungen. Dabei steht die Sterilerhaltung der chirurgischen Instrumente an oberster Stelle.

Aesculap Sterilcontainer entsprechen in allen Komponenten den Anforderungen der nationalen und internationalen Standards zur Sterilverpackung, insbesondere:

- DIN EN ISO 11607
- DIN 58953, Teil 9
- MDD 93/42/EWG

Das solide, robuste Design und die von Aesculap eingesetzten Fertigungstechnologien garantieren ein Höchstmaß an Formgenauigkeit und Stabilität der Sterilcontainer, Instrumentensiebkörbe und anderer Systemkomponenten. In Verbindung mit hochwertigen Materialien wird eine langjährige, nahezu wartungsfreie Funktion der Sterilcontainer ermöglicht.

## Reprocessing, Care & Maintenance – Aufbereitung und Pflege



### Sterilit® – Oil spray

- Base: paraffin/white oil
- reduces friction and protects against friction corrosion
- suitable for steam sterilization procedures in accordance with ISO 17665-1 and for hot air sterilization up to max. 180°C

### Sterilization

Its special composition enables steam to penetrate the oil film during the sterilization process.

### Sterilit® – Pflegeöle

- Basis: Paraffin-/Weißöl
- verringert Reibung und schützt gegen Reibkorrosion
- geeignet für Dampfsterilisationsverfahren nach ISO 17665-1 und Heißluftsterilisation bis max. 180°C

### Sterilisation

Die spezielle Rezeptur macht es möglich, dass der Wasserdampf den Ölfilm während des Sterilisationsprozesses durchdringt, auch an schwer zugänglichen Stellen.

## Reprocessing, Care &amp; Maintenance – Aufbereitung und Pflege

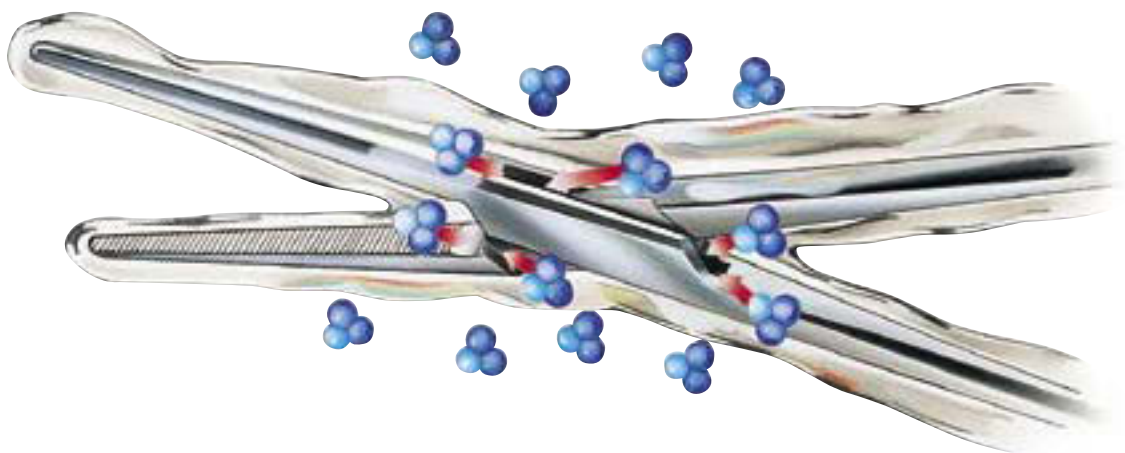

### Aesculap maintenance oils Sterilit® I, Sterilit® Power Systems

#### Applications

All Sterilit® maintenance oils are validated for steam sterilization methods according to ISO 17665-1, as well as for dry heat (heated air) sterilization up to 180°C. They are applied prior to sterilization. (Caution! Motor systems are not suitable for hot air sterilization)

Sterilit®	Art. No.
Sterilit® I, spray	JG600
Sterilit® I, drip oiler	JG598
Sterilit® Power Systems, spray	GB600
Sterilit® Power Systems, drip oiler	GA059

### Aesculap Pflegeöl für Instrumente Sterilit® I, Sterilit® Power Systems

#### Einsatzgebiet

Alle Sterilit®-Pflegeöle sind für Dampfsterilisations-Verfahren validiert nach ISO 17665-1 und zur Heißluftsterilisation bis max. 180°C geeignet. Sie werden vor der Sterilisation angewendet. (Achtung: Motorensysteme sind nicht für die Heißluftsterilisation geeignet)

Sterilit®	Art. Nr.
Sterilit® I, Spray	JG600
Sterilit® I, Tropföler	JG598
Sterilit® Power Systems, Spray	GB600
Sterilit® Power Systems, Tropföler	GA059

# Reprocessing, Care & Maintenance – Aufbereitung und Pflege

## Registration

Sterilit® oils are registered as medical accessory class 1 in conformity with Annex 1 MDD 93/42/EEC; CE marking according to directive 93/42/EEC.

## Properties

- Steam-permeable oil film
- The oil film has no adverse effect on the sterilization performance
- Lubricating effect and corrosion protection
- Silicon-free, no staining and incrustation on instrument surfaces

## Biological safety – toxicology

There is no evidence of hazards to patients who have been attended (surgical application) with medical devices treated with Sterilit®. This is only valid as long as Sterilit® is properly used according to the respective instructions for use. Tested with real-time aged products according EN ISO 10993-1.

## Safe handling

- Only apply prior to sterilization.
- Store in a cool and dry place protected from light.
- Take note of the use-by date.
- Before Sterilit® can be applied, medical devices must be cleaned and disinfected according to their instructions for use.

## Warning

- Avoid release to the environment.
- Refer to instructions for use/safety data sheets.

## Registrierung

Sterilit® Öle sind registriert als medizinisches Zubehör der Klasse 1 gemäß Anhang 1 MDD 93/42/EWG; CE-Zeichen gemäß Richtlinie 93/42/EWG.

## Eigenschaften

- Wasserdampfdurchlässiger Ölfilm
- Keine Beeinträchtigung der Sterilisationswirkung durch den Ölfilm
- Schmierwirkung und Korrosionsschutz
- Silikonfrei, keine Flecken- und Krustenbildung auf Instrumentoberflächen

## Biologische Sicherheit – Toxikologie

Es ist kein Nachweis bekannt, dass Patienten, die mit Sterilit® gepflegten Medizinprodukten behandelt wurden, zu Schaden gekommen sind. Dies setzt jedoch voraus, dass Sterilit® ordnungsgemäß, wie in der Gebrauchsanweisung beschrieben, eingesetzt wird. Nachweis gemäß EN ISO 10993-1 mit Echzeit gealterten Ölen.

## Sichere Handhabung

- Nur vor der Sterilisation anwenden.
- Kühl, trocken und lichtgeschützt lagern.
- Mindesthaltbarkeitsdatum beachten.
- Vor der Verwendung von Sterilit®, Medizinprodukte gemäß Gebrauchsanweisung reinigen und desinfizieren.

## Warnung

- Freisetzung in die Umwelt vermeiden.
- Gebrauchsanweisung beachten/Sicherheitsdatenblatt zu Rate ziehen.

\*Sales unit: **PAK** = Package of 6 bottles  
Bestelleinheit: **PAK** = Packung à 6 Stück



### \*JG600

Aesculap® Sterilit® Oil Spray in spray cans for instrument care prior to sterilization  
Aesculap® Sterilit® Ölspray, in Spraydosen, zur Instrumentenpflege vor der Sterilisation



### \*GB600

Aesculap® Sterilit® Power Systems Oil Spray in spray cans, for Aesculap power systems care prior to sterilization  
Aesculap® Sterilit® Power Systems Ölspray, in Spraydosen, zur Pflege von Aesculap Motorensystemen vor der Sterilisation



**GB600810**  
micro-Line



**GB600820**  
microspeed uni,  
HiLAN / HiLAN XS,  
Hi-Line (XS, XXS)



**GB600830**  
mini-Line



**GB600840**  
Acculan 3Ti



**GB600870**  
microspeed  
uni XS



### JG598

Aesculap® Sterilit® instrument oil for instrument care prior to sterilization  
Aesculap® Sterilit® Instrumentenöl, zum Ölen der Schlüsse, Sperren usw. vor der Sterilisation



### GA059

Aesculap® Sterilit® drip oiler, for lubricating Aesculap motors and handpieces prior to sterilization  
Aesculap® Sterilit® Tropföler, zum Ölen der Gleitlager an Aesculap Motoren vor der Sterilisation

## Reprocessing, Care & Maintenance – Aufbereitung und Pflege

You will find detailed information about the reprocessing of individual Aesculap products in the data base "Reprocessing/Instructions for Use" on the internet:

[www.aesculap-extra.net](http://www.aesculap-extra.net)

Ausführliche Informationen zur Aufbereitung individueller Aesculap Produkte finden Sie in der Datenbank „Aufbereitung/Gebrauchsanweisungen“ im Internet unter:

[www.aesculap-extra.net](http://www.aesculap-extra.net)

For general information about reprocessing:



Brochure C71002

[www.r-k-i.org](http://www.r-k-i.org)

Für allgemeine Informationen zur Aufbereitung:



Broschüre C71001

[www.r-k-i.org](http://www.r-k-i.org)



**Index**  
Index

- **Alphabetical Index**
- **Alphabetischer Index**

## Alphabetical Index

## A – B

	Page		Page
<b>A</b>			
<b>ABRAHAM</b> , tonsil forceps	137	Approximators	195, 196
tonsil knives	140	micro	194
<b>ACLAND</b> , approximators	196	nerve	195
clip applying forceps	197	Arachnoid blades	369
vessel clips	196	Arteriotomy scissors	416
Adapters, air cartridge, UNITRAC	60	<b>ASH</b> , septum forceps	112
light guides	58	ATRAUMATA, bulldog clamps	461–463
MINOP TREND	63	clamps	464, 466, 467
suction	44, 528	dissecting forceps	438, 439, 465
Adenoid curettes	146–148	dissecting forceps, TITANIUM	437
Adenotome blades	149	forceps, micro	180
Adenotomes	149	ligature forceps	465
<b>ADLERKREUTZ</b> , tissue forceps	454	micro forceps	180
<b>ADSON</b> , delicate dissecting forceps	429	organ grasping forceps	495
delicate hemostatic forceps	475	tissue grasping forceps	495
delicate tissue forceps	445, 446	ultra light forceps	436
dissecting forceps, bayonet-shaped	442	vessel clamps, TITANIUM	468, 469
DUROGRIP non-traumatic dissecting forceps	440	<b>AUFRIEHT</b> , bone rasps	240
nerve and vessel hooks	292	nasal retractor	103
raspatories	208, 212	<b>AUSTIN</b> , micro suture tying forceps	177
suction cannulas	529	Awls	239
tissue forceps	447	bone	239
TITANIUM delicate dissecting forceps	428	<b>B</b>	
<b>ADSON–BABY</b> , self-retaining retractors	282	<b>BABCOCK</b> , organ and tissue grasping forceps	494, 495
<b>ADSON–BROWN</b> , tissue forceps	447	<b>BABY–ADSON</b> , dissecting and ligature forceps	485
<b>AESCULAP</b> , instrument organisation system	46–47	<b>BABY–ALLIS</b> , dissecting and ligature forceps	492
micro bone mill kit	111	<b>BABY–CRILE (KOCHER)</b> , delicate hemostatic forceps	472
sponge and dressing forceps	345	<b>BABY–CRILE (PEAN)</b> , delicate hemostatic forceps	472
Air cartridge, CO <sub>2</sub> , UNITRAC	60	<b>BABY–CRILE–WOOD</b> , DUROGRIP needle holder	502
adapter, UNITRAC	60	<b>BABY–METZENBAUM</b> , dissecting scissors	422
Alar retractors	102	DUROTIP dissecting scissors	384, 387
<b>ALEXANDER</b> , bone rongeurs	246	NOIR dissecting scissors	376
gouges	227	Supercut dissecting scissors	395
<b>ALLENBERG</b> , carotid retractor	279	<b>BABY–MIKULICZ</b> , peritoneum forceps	491
Alligator forceps	16, 17	<b>BABY–MIXTER</b> , dissecting and ligature forceps	484
<b>ALLIS</b> , ATRAUMATA organ and tissue grasping forceps	495	<b>BABY–MOSQUITO (HARTMANN)</b> , delicate hemostatic forceps	470
organ and tissue grasping forceps	493	<b>BABY–OVERHOLT</b> , dissecting and ligature forceps	484
<b>ALLIS–ADAIR</b> , organ and tissue grasping forceps	492	<b>BABY–ROUX</b> , retractors	314
<b>ALLIS–THOMS</b> , organ and tissue grasping forceps	494	<b>BABY–SENN–MILLER</b> , retractors	312
<b>ALLPORT</b> , self-retaining retractors	276	<b>BACKHAUS</b> , towel clamps	351
Anatomy scissors	404	<b>BACKHAUS–KOCHER</b> , towel clamps	351
<b>ANGLE</b> , wire cutters	270	<b>BALLENGER</b> , septum gouge	105
Angular dissecting forceps	444	swivel knives	96
Antrum, curettes	77, 78	Bandage scissors	425, 426
grasping forceps	69	<b>BANE–HARTMANN</b> , bone rongeurs	245
hooks	30	<b>BARNHILL</b> , adenoid curettes	147
punches	66, 67	<b>BARRAQUER</b> , micro needle holders	181
rasps	79	<b>BARRON</b> , scalpel handles	363
retractor	78, 331	suction cannulas	535
trocars	79	<b>BARTH</b> , bone curettes	216
Application instruments	31	<b>BAUMGARTNER</b> , DUROGRIP needle holders	266, 502
Applicators, cotton	520–522	DUROGRIP wire twisters	266
Applying forceps, bulldog clamps	459		
clips	193, 194, 197, 198		

## Alphabetical Index

## B – C

	Page		Page
Bayonet-shaped, dissecting forceps	442, 443	Bone, retractors	322, 323
dissecting forceps, DUROGRIP	441	rongeurs	243-247
forceps	113	shears	249
<b>BEALES</b> , raspatories	38	<b>BONNER MODELL</b> , micro suture tying forceps	177
<b>BECKMANN</b> , adenoid curettes	146	<b>BONNEY</b> , dissecting forceps	435
nasal speculas	52	<b>BOSE</b> , self-retaining retractors	275
<b>BEEBE</b> , wire cutting scissors	269	tracheal retractors	298
<b>BELLUCCI</b> , micro scissors	14	<b>BOUCHERON</b> , ear speculas	2
suction set	526	Bougies, frontal sinus	80
<b>BERGMANN</b> , tracheal retractors	298	<b>BOWMAN</b> , eye probes	519
<b>BERNHARD</b> , towel clamps	351	<b>BOYS-ALLIS</b> , organ and tissue grasping forceps	492
<b>BEYER</b> , bone rongeurs	246, 247	<b>BRASKY</b> , skin hooks	297
<b>BIEMER</b> , approximator for nerves	195	<b>BRAUN</b> , organ and tissue grasping forceps	135
clip applying forceps	193, 194	<b>BRODIE</b> , directors	516
micro approximators	194	<b>BROM</b> , vein hook	291
micro vein scissors	170	<b>BROPHY</b> , delicate dissecting forceps	432
vessel clips	192	<b>BROWN</b> , tissue forceps	447
<b>BIEMER-MUELLER</b> , micro approximators	194	<b>BRUENINGS</b> , septum forceps	71
<b>BILEAU</b> , ear loops	10	tongue spatulas	118
Biopsy forceps, micro laryngeal	157	tonsil snares	142
Bipod	134	<b>BRUENINGS-BRUNKS</b> , antrum retractor	78, 331
<b>BIRKETT</b> , delicate hemostatic forceps	477	<b>BRUNS</b> , bone curettes	220
<b>BISHOP-HARMON</b> , delicate tissue forceps	445	<b>BRYANT</b> , sponge and dressing forceps	343
eye forceps	445	<b>BUCHWALD</b> , tongue spatulas	118
Blade holder, ERGOPLANT	368	<b>BUCK</b> , cotton applicator	521
Blades, adenotome	149	ear curettes	11
arachnoid	369	foreign body instrument	13
microsurgical	369	<b>BUECHS</b> , raspatories	212
scalpel	366, 367	retractors	335
<b>BLAKESLEY-WILDE</b> , nasal forceps	73	Bulldog, clamps	459, 460
<b>BLOHMKE</b> , tonsil forceps	137	clamps, ATRAUMATA	461-463
<b>BLUMENTHAL</b> , bone rongeurs	245	scissors	412
<b>BOEHLER</b> , bone cutting forceps	250	<b>BUSER</b> , raspatory	207
bone rongeurs	247		
<b>BOETTCHER</b> , tonsil scissors	141	<b>C</b>	
<b>BOIES</b> , nasal fracture elevators	113		
Bone, awls	239	Cables, light	58, 154
crusher	109	<b>CAIRNS</b> , bone flap elevators	200
curettes	216-222	delicate hemostatic forceps	473
curettes, ERGOPLANT	218	dura retractors	294
cutting forceps	248-250	<b>CAIRNS-DOTT</b> , delicate dissecting forceps	432
cutting forceps, ERGOPLANT	244, 248	Calipers	96, 356
files	240, 241	Cannula heads	542, 543
fixation forceps	252	Cannulas	541
flap elevators	200	irrigation	79, 80, 540
holding forceps	252, 253	suction	43, 44, 527-538, 540
mill cleaner, ERGOPLANT	110	suction, Fukushima design	531
mill kit, micro	111	suction, micro	532
mill, micro, ERGOPLANT	110	<b>CANNY-RYALL</b> , retractors	321
punches	255-257, 262-265	Carotid retractor	279
punches, detachable	262-264	<b>CARREL</b> , delicate hemostatic forceps	470
punches, NOIR	258-261	Cartilage, morselizer forceps	113
punches, non-detachable	265	scissors	417
rasps	240, 241	slitting knives	97
rasps, DUROGRIP	99, 242		
rasps, ERGOPLANT	241		

## Alphabetical Index

## C

	Page		Page
<b>CASPAR</b> , exploration hooks	293	<b>CONVERSE</b> , nasal knives	98
raspatories	211	<b>COOLEY</b> , ATRAUMATA clamps	464
retractors	336	ATRAUMATA dissecting forceps	439
scalpel handle	368	delicate dissecting forceps	433
tampers	238	vascular scissors	423
<b>CASTROVIEJO</b> , calipers	96	<b>COOPER</b> , surgical scissors	409
delicate tissue forceps	445	Corneal forceps	429
DUROGRIP needle holders	190, 191	<b>COTTLE</b> , alar retractors	102
eye forceps	445	bulldog scissors	412
eye scissors	169	elevators	99, 101, 203
micro needle holders	183	fishtail osteotomes	106
micro scissors	168	fixation forceps	113
needle holders, DUROGRIP	190, 191	mallets	235
Catheter, eustachian	8	nasal scissors	91
introducing forceps	355	nasal speculas	56
<b>CAWTHORNE</b> , micro grasping forceps	18	osteotomes	106
micro scissors	15	raspatories	99, 101, 211
Cerumen Scoops	8, 10	septum forceps	112
<b>CHADWICK</b> , delicate scissors	403	septum knives	98
Chain	122	septum speculas	57
<b>CHAPUT</b> , organ and tissue grasping forceps	492	skin hooks	295
Chest supports	134, 153	vein retractors	309
Chisels	108, 223, 225-227, 230, 232, 233	<b>COTTLE-KNAPP</b> , dissecting scissors	413
flat	42	<b>COTTLE-MASING</b> , delicate dissecting scissors	413
<b>CHOMPRET</b> , syndesmotomes	202	Cotton applicators	520-522
<b>CINELLI</b> , osteotomes	105	<b>CRAIG</b> , septum forceps	95
<b>CITELLI</b> , cup forceps	22	<b>CRAIG-DOMNICK</b> , septum forceps	95
punches	255	<b>CRILE</b> , delicate hemostatic forceps	472, 474
Clamping arm	6	nerve and vessel hooks	291
Clamps, ATRAUMATA	464, 466, 467	retractors	315
ATRAUMATA bulldog-	461-463	<b>CRILE-WOOD</b> , DUROGRIP needle holder	502
bulldog-	459, 460	Crimping forceps, implant	39
bulldog, ATRAUMATA	461-463	Crurotomy scissors, micro	15
collumela	113	Crusher, bone	109
towel	351-354	Cup forceps	21, 22, 24
tubing	342, 349, 350	micro	19, 20
Cleaner for bone mill, ERGOPLANT	110	micro laryngeal	156, 157
Clip applying forceps	193, 194, 197, 198	Curettes	40, 41
Clips, vessel	192, 196, 198, 458	adenoid	146-148
vessel, non-traumatic	458	antrum	77, 78
Cloth scissors	425, 426	bone	216-219
CO <sub>2</sub> air cartridge, UNITRAC	60	bone, ERGOPLANT	218
adapter, UNITRAC	60	ear	11
<b>COAKLEY</b> , antrum currettes	78	endaural	220-222
<b>COLLER</b> , delicate hemostatic forceps	474	frontal sinus	77
<b>COLLIN</b> , ATRAUMATA organ and tissue grasping forceps	495	TREND	86-88
organ and tissue grasping forceps	496, 497	TREND, deflectable	86
retractors	316	<b>CUSHING</b> , delicate dissecting forceps	432
sponge holding and dressing forceps	497	DUROGRIP dissecting forceps	441
tongue forceps	497	nerve and vessel hooks	291, 293
<b>COLLIN-HARTMANN</b> , retractors	313	tissue forceps	450
Collumela clamps	113	vein retractors	311
<b>COLVER</b> , tonsil forceps	136	<b>CUSHING-KOCHER</b> , vein retractor	310
Conchotomes	70	<b>CUSHING-LANDOLT</b> , pituitary speculas	81
Cone knives	364, 366	Cutters, wire	270, 271
<b>CONVERSE</b> , DUROGRIP needle holder	501	Cutting plates, ERGOPLANT	110

## Alphabetical Index

C - D

	Page		Page
<b>CZERNY</b> , organ and tissue grasping forceps	135	Dia Dust, micro needle holders	185-189, 507
retractors	320	micro needle holders, TITANIUM	166, 167, 507
		micro tissue forceps	180
		needle holders, micro	185-189, 507
		needle holders, micro, TITANIUM	166, 167, 507
		tissue forceps, micro	180
<b>D</b>		Diamond, knives	371
<b>DANDY</b> , delicate hemostatic forceps	471	rasps	240
<b>DAUBENSPECK</b> , bone curettes	222	<b>DIEFFENBACH</b> , bulldog clamps	459
<b>DAUTREY</b> , osteotomes	227	<b>DIETER</b> , hammer head punches	23
<b>DAVIES-BOYLE</b> , frame for tongue depressors	126	<b>DIETRICH</b> , bulldog clamps	460
tongue spatulas	131	Dilators, for lacrymal duct	519
<b>DAVIES-MEYER</b> , frame for tongue depressors	125	micro vessel	179
<b>DE BAKEY</b> , arteriotomy scissors	416	tracheal	274
ATRAUMATA bulldog clamps	462	<b>DINGMANN</b> , bone holding forceps	253
ATRAUMATA clamps	466, 467	mouth gags	124
ATRAUMATA coarctation clamps	466	<b>DINGMANN MODIF.</b> , bone holding forceps	253
ATRAUMATA dissecting and ligature forceps	465	Directors	516
ATRAUMATA dissecting forceps	438, 439	Disposable scalpels	360-362
ATRAUMATA peripheral clamps	467	Dissecting forceps	431-435, 475, 477, 484-490
ATRAUMATA ultra light forceps	436	angular	444
<b>DUROGRIP</b> needle holders	505	ATRAUMATA	438-440, 465
self-retaining retractors	285	ATRAUMATA TITANIUM	437
suction cannulas	536, 537	bayonet-shaped	442, 443
TITANIUM ATRAUMATA dissecting forceps	437	bayonet-shaped, <b>DUROGRIP</b>	441
TITANIUM ATRAUMATA vessel clamps	468, 469	delicate	429-431
<b>DE BAKEY-HESS</b> , bulldog clamps	460	delicate, TITANIUM	428, 431
<b>DEAN</b> , tonsil scissors	141	Dia Dust	180
<b>DEAVER</b> , surgical scissors	411	<b>DUROGRIP</b>	440, 441
Deflectable <b>TREND</b> , curette	86	micro, Dia Dust	180
dissector	86	Dissecting scissors	412, 418-422, 485
knife	86	delicate	398, 399, 406, 412-417
Delicate, dissecting forceps	429-431	delicate, <b>DUROTIP</b>	383-388
dissecting forceps, TITANIUM	428, 431	delicate, <b>NOIR</b>	375, 377-379
dissecting scissors	398, 399, 412-417	delicate, wavecut	375, 377-379, 386-388
dissecting scissors, <b>DUROTIP</b>	383-388	<b>DUROTIP</b>	382, 383, 385-389
dissecting scissors, <b>NOIR</b>	375, 377-379	micro	171
dissecting scissors, wavecut	375, 377-379, 386-388	nerve	399, 406, 415
tissue forceps, TITANIUM	428	<b>NOIR</b>	375-379
hemostatic forceps	470-477	suction tubes	104, 539
nasal forceps	73	Supercut	394-396
scissors	397, 400-406	wavecut	377-379, 386-389
scissors, <b>DUROTIP</b>	380	Dissectors, micro	37
scissors, Supercut	392	suction	104, 538
tissue forceps	431, 445, 446, 448, 449	tonsil	138, 139, 539
<b>DENHARDT</b> , mouth gag	123	<b>TREND</b>	87, 88
<b>DENIS-BROWNE</b> , tonsil forceps	137	<b>TREND</b> , deflectable	86
Depressors, tongue	118	<b>DIXON-LOVELACE</b> , delicate hemostatic forceps	475
<b>DERF</b> , <b>DUROGRIP</b> needle holder	500	<b>DOCKHAM</b> , retractors	336
Dermal punches	115	Double ended probes	518
Dermatomes, spare blades	115	<b>DOUGHTY</b> , tongue spatulas	132
<b>DERRA</b> , ATRAUMATA clamps	464	<b>DOYEN</b> , directors	516
<b>DESCHAMPS</b> , ligature needles	510-512	raspatories	215
<b>DESMARRES</b> , vein retractors	309	rib raspatories	215
Dia Dust, dissecting forceps, micro	180	<b>DOYEN-COLLIN</b> , mouth gags	121
micro dissecting forceps	180	<b>DOYEN-JANSEN</b> , mouth gags	121

## Alphabetical Index

## D – F

	Page		Page
<b>DRAFFIN</b> , bipod	134	<b>ERGOPLANT</b> , cleaner for bone mill	110
Dressing forceps	342-348, 497	cutting plates	110
<b>DUNHILL</b> , delicate hemostatic forceps	472, 477	<b>DUROGRIP</b> forceps	428
Dura retractors	294, 297	forceps, atraumatic	428
<b>DURHAM</b> , retractors	333	forceps, <b>DUROGRIP</b>	428
<b>DUROGRIP</b> , <b>ATRAUMATA</b> dissecting forceps	440	forceps, for soft tissue	428
bone rasps	99, 242	forceps, micro	180
dissecting forceps	440, 441	forceps, tissue	428
dissecting forceps, bayonet-shaped	441	micro bone mill	110
forceps	266, 441	micro forceps	180
micro needle holders	190, 191	mouth wedge, silicone	122
needle holders	500-506, 508, 509	rongeurs	244
needle holders, micro	190, 191	silicone mouth wedge	122
needle holders, with scissors	504	soft tissue forceps	428
suture forceps	441	tissue forceps	428
wire holding forceps	266	tongue retractor	120
wire twisters	266	Ethmoidal forceps	72, 74-76
<b>DUROTIP</b> , delicate scissors	380	Eustachian catheters	8
dissecting scissors	382-385	<b>EVES</b> , tonsil snares	142
ligature scissors	380, 386, 390	tonsil snares, <b>SUSI</b>	142
scissors	268, 380-390	Exploration hooks	293
surgical scissors	381	Eye, forceps	445
wavecut scissors	386-390	probes	519
wire cutting scissors	268	scissors	169
<b>DUVAL-COLLIN</b> , organ and grasping forceps	496		
<b>E</b>			
Ear, curettes	11	<b>FAHLBUSCH</b> , micro scissors	83
hooks	12, 288	<b>FARABEUF</b> , raspatories	213
levers	10, 12	retractors	315
loops	10	<b>FARABEUF-COLLIN</b> , raspatories	213
probes	8, 519	<b>FARRELL</b> , cotton applicators	520, 522
snares	13	<b>FEILCHENFELD</b> , splinter forceps	455
specula support	6	<b>FERGUSSON</b> , bone holding forceps	252
speculas	2-5	suction cannulas	530, 533
tampon forceps	24	<b>FERGUSSON-ACKLAND</b> , mouth gags	123
<b>EAST GRINSTEAD (WARD)</b> , chisels	230	<b>FERRIS-SMITH</b> , <b>DUROGRIP</b> dissecting forceps	441
osteotomes	230	<b>FICKLING</b> , hemostatic forceps	482
<b>EICKEN</b> , irrigating cannulas	79	Files, bone	240, 241
Elevators	99-101, 200-203	round	234
bone flap	200	Fine retractors	294, 296, 297
nasal fracture	113	<b>FINSEN</b> , self-retaining retractors	275
stapes	36	<b>FINSEN MODIF.</b> , self-retaining retractors	275
<b>EMMET</b> , fistula hook	307	<b>FISCH</b> , dura retractors	297
Endaural curettes	220-222	<b>FISHER</b> , tonsil knives	140
Endoscopes	64	Fishtail osteotomes	106
Enucleation scissors	413	Fistula hooks	307
Enucleators, <b>TREND</b>	86, 88	Fixation, device	6
<b>ERGOPLANT</b> , atraumatic forceps	428	forceps	113, 352
blade holder	368	Fixing element, flexible	60, 62
bone curettes	218	Flap knives, micro	32
bone cutting forceps	244, 248	Flat chisels	42
bone rasp	241	Flexible fixing element	60, 62
		<b>FOERSTER-BALLENGER</b> , sponge holding and dressing forceps	348
<b>F</b>			

## Alphabetical Index

## F

	Page		Page
<b>FOMON</b> , alar retractors	102	Forceps, ligature	435, 458, 475, 477, 484-490
bone files	241	ligature, ATRAUMATA	465
bone rasps	241	micro	18-20, 83, 180
lower lateral scissors	413	micro laryngeal biopsy	157
nasal scissors	91	micro laryngeal cup	156-157
osteotomes	105	micro laryngeal grasping	155
Supercut scissors	393	micro, ATRAUMATA	180
Footplate hooks, micro	29	micro, dissecting	180
Forceps, alligator	16, 17	micro, ERGOPLANT	180
antrum	69	micro, jeweler patterns	176
applying, bulldog clamps	459	micro, suture tying	177, 178
ATRAUMATA dissecting	438-440, 465	micro, tissue	180
ATRAUMATA grasping	495	nasal	73, 94
ATRAUMATA ligature	465	nasal pharyngeal	150
ATRAUMATA organ grasping	495	nasal tampon	92, 93
ATRAUMATA tissue grasping	495	organ grasping	135, 492-497
ATRAUMATA ultra light	436	organ grasping, ATRAUMATA	495
bayonet-shaped	113	peritoneum	491
bone cutting	248-250	polypus	160, 497
bone cutting, ERGOPLANT	244, 248	removing, bulldog clamps	459
bone fixation	252	reposition	254
bone holding	252, 253	rib holding	253
cartilage morselizer	113	septum	71, 95, 112
catheter introducing	355	sinus	343
clip applying	193, 194, 197, 198	soft tissue ERGOPLANT	428
corneal	429	splinter	455
cup	19-22, 24	sponge	342
delicate	73, 429-433, 445, 446, 448, 449	sponge holding	348, 497
delicate, hemostatic	470-477	spreading	81
delicate, TITANIUM	428, 431	suture tying	177, 178
Dia Dust	180	suture, DUROGRIP	441
dissecting	431-435, 475, 477, 484-490	tissue	447, 450-454
dissecting, angular	444	tissue grasping	135, 492-497
dissecting, ATRAUMATA	438, 439, 465	tissue grasping, ATRAUMATA	495
dissecting, bayonet-shaped	441-443	tissue, delicate	431, 445-449
dissecting, delicate	429-431	tissue, Dia dust	180
dissecting, Dia Dust	180	tissue, ERGOPLANT	428
dissecting, DUROGRIP	440, 441	tongue	117, 497
dressings	342-348, 497	tonsil	136, 137, 140, 483
DUROGRIP	440, 441	tubing	478
DUROGRIP, wire holding	266	tubular shaft	155
ear tampon	24	tumor	454
ethmoidal	72, 74-76	tumor grasping	85
eye	445	ultra light, ATRAUMATA	436
fixation	113, 352	vascular	454
giraffe	68	wire bending	23
grasping	135	wire holding, DUROGRIP	266
grasping, ATRAUMATA	495	Foreign body instruments	13
grasping, organ	135, 492-497	Forked hooks, triangle handle	300
grasping, tissue	135, 492-497	Forks, guide	31
grasping, tumor	85	suture	144
hemostatic	342, 478-483	tuning	7
hemostatic, delicate	470-477	<b>FORMBY</b> , cerumen scoops	8
implant crimping	39	suction cannulas	534
iris	429	<b>FOWLER</b> , tonsil knives	140
laryngeal	160, 161	<b>FRAENKEL</b> , laryngeal forceps	161





## Alphabetical Index

H – J

	Page		Page
Handles, irrigation/suction, MINOP TREND	63	Holders, needle, Dia Dust, TITANIUM	166, 167, 507
laryngeal instruments	158	needle, DUROGRIP	190, 191, 500-509
mirror	150	Holding arm	62
scalpel	363-365, 368, 369	Hooks, antrum	30
suction	43	ear	12, 288
tonsillotome	145	exploration	293
<b>HARDY, TREND</b> curettes	86-88	fistula	307
TREND enucleators	86, 88	footplate	29
<b>HARTMANN</b> , conchotomes	70	micro	27-30, 158
cup forceps	21, 22	nasal	103
ear speculas	2-3	nerve	12, 290-293
ear tampon forceps	24	parotid	308
eustachian catheters	8	skin	294-297
grasping forceps	18	tendon	308, 309
nasal speculas	51, 53, 54	treangle handle	300, 301, 304
nasal tampon forceps	93	TREND	87, 88
tongue spatulas	120	thyroid	311
tonsil punches	145	vein	291
tuning forks	7	vessel	290-293
<b>HARTMANN-HALLE</b> , nasal speculas	51	<b>HOUGH</b> , grasping forceps	18
<b>HARTMANN-WULLSTEIN</b> , cup forceps	21	<b>HOUSE</b> , bone curettes	217
grasping forceps	18	curettes	40, 41
<b>HARVEY</b> , wire cutting scissors	268	suction adapter	44, 528
<b>HEERMANN</b> , flat chisels	42	suction and irrigation cannulas	540
gouges	42	<b>HOWARD</b> , raspatories	101
handles	42	<b>HUDSON</b> , delicate dissecting forceps	429
mallets	42	tissue forceps	447
<b>HEGAR-MAYO</b> , DUROGRIP needle holder	503	<b>HUGHES</b> , stapes mobilisators	31
<b>HEGAR-MAYO-SEELEY</b> , DUROGRIP needle holder	503	<b>HUNTER</b> , splinter forceps	455
<b>HEGAR-OLSEN</b> , DUROGRIP needle holder with scissors	504	<b>HURD</b> , ligature needles	512
<b>HEGAR-OLSEN MODIF. LANGE</b> , DUROGRIP needle holder with scissors	504	tonsil dissector	138
<b>HEISS</b> , delicate hemostatic forceps	477		
dissecting and ligature forceps	488	<b>I</b>	
<b>HEISTER</b> , mouth gags	121	Implant crimping forceps	39
<b>HEMINGWAY</b> , bone curettes	218, 219	Incision scissors	411
Hemostatic forceps	342, 478-483, 496	Instrument organisation system	46-47
delicate	470-477	Instruments, foreign body	13
<b>HENCKEL-TILLEY</b> , rongeurs	74	ligature	144
<b>HENKE</b> , tonsil dissector	138	measuring	39
<b>HENKEL</b> , cup forceps	24	Iris, forceps	429
<b>HEYMANN</b> , nasal scissors	90	scissors	397, 400
<b>HEYMANN-KNIGHT</b> , nasal scissors	90	Irrigating cannulas	79, 80, 540
septum forceps	95	Irrigation, handles, MINOP TREND	63
<b>HEYWOOD-SMITH</b> , organ- and tissue grasping forceps	497	shafts, MINOP TREND	64
sponge holding and dressing forceps	497	tubes, MINOP TREND	63
tongue forceps	497		
<b>HEYWOOD-SMITH MODIF.</b> , organ- and tissue grasping forceps	497	<b>J</b>	
sponge holding and dressing forceps	497	<b>JACOBSON</b> , bone curettes	216
tongue forceps	497	delicate hemostatic forceps	471, 476
<b>HILL</b> , raspatories	101	micro needle holders	183
<b>HOESEL</b> , DUROGRIP needle holder	509		
Holders, laryngoscope	153		
needle	181-185, 501		
needle with scissors, DUROGRIP	504		
needle, Dia Dust	185-189, 507		

## Alphabetical Index

## J – L

	Page		Page
<b>JACOBSON</b> , micro scissors	171	<b>KILNER</b> , fine retractors	297
<b>JAEGER</b> , skin hooks	296	retractors	312, 318
<b>JAMESON</b> , delicate dissecting scissors	415	skin hooks	295
Supercut scissors	393	<b>KINGS' S COLLEGE HOSPITAL</b> , cotton applicators	521
<b>JAMESON-WERBER</b> , delicate dissecting scissors	415	<b>KIRSCH</b> , retractors	333
<b>JANSEN</b> , bone curettes	216, 218	<b>KIRSTEIN</b> , nasal scissors	90
bone rongeurs	245, 246	<b>KLAPP</b> , tendon hook	308
dissecting forceps, bayonet-shaped	442	<b>KLEINERT-KUTZ</b> , skin hooks	295
raspatories	210, 211	<b>KLINIKUM BERLIN</b> , tubing clamps	349
self-retaining retractors	276	Knives, cartilage slitting	97
<b>JANSEN-MIDDLETON</b> , nasal forceps	94	cone	364, 366
<b>JATHO</b> , nasal pharyngeal forceps	150	diamond	371
<b>JEFFERSON</b> , delicate dissecting forceps	429	flap	32
delicate tissue forceps	446	furuncle	9
self-retaining retractors	284	laryngeal micro	158
<b>JOBSON-HORNE</b> , ear probes	8	laryngeal sickle	158
<b>JOHNS-HOPKINS</b> , bulldog clamps	459	micro	31-35, 158
applying and removing forceps	459	mucous	96
<b>JOLL (FRIEDMAN)</b> , thyroid retractors	287	nasal	97, 98
<b>JOSEPH</b> , bone files	240	round cutting	33-35, 158
delicate scissors	397, 406	septum	98
iris scissors	397	sickle	9, 77, 158
nasal knives	97, 98	skin grafting	115
nasal saws	99	swivel	96
raspatories	209	tonsil	140
skin hooks	296	TREND, deflectable	86
retractors	296	<b>KOCHER</b> , bone retractors	322
Supercut dissecting scissors	394	guide probes	514
<b>JUDD-ALLIS</b> , organ and tissue grasping forceps	494	hemostatic forceps	480
<b>JURASZ</b> , laryngeal polypus forceps	160	retractors	322, 331, 337
nasal pharyngeal forceps	150	vein retractors	310
<b>K</b>			
<b>KANTROWITZ</b> , dissecting and ligature forceps	489	<b>KOCHER-LANGENBECK</b> , retractors	327
<b>KAYE</b> , Supercut dissecting scissors	396	<b>KOCHER-OCHSNER</b> , hemostatic forceps	481
<b>KAZANJIAN</b> , bone cutting forceps	248	<b>KOENIG</b> , elevators	200, 208
<b>KELLY</b> , delicate hemostatic forceps	471	guide probes	513
delicate scissors	406	raspatories	208
<b>KERRISON</b> , punches	255	vein retractors	310
punches, detachable	262-264	<b>KOFLER</b> , punches	257
punches, NOIR	258-261	<b>KRAEMER</b> , raspatories	214
punches, non-detachable	265	retractors	335
<b>KEYES</b> , dermal punches	115	<b>KRAUSE</b> , ear snares	13
<b>KILLIAN</b> , bone shears	249	nasal polypus snares	114
elevators	100	<b>KRAYENBUEHL</b> , nerve and vessel hooks	292
laryngectomy scissors	161	<b>KROENLEIN</b> , hemostatic forceps	342
nasal probe	519	<b>KRONECKER</b> , ligature needles	510
nasal speculas	55, 56	<b>L</b>	
raspatories	100	<b>LA FORCE</b> , adenotome blades	149
septum gouge	107	adenotomes	149
<b>KILLIAN-CLAUS</b> , septum gouge	107	<b>LA GRANGE</b> , delicate scissors	405
<b>KILNER</b> , delicate dissecting scissors	412, 415	<b>LABORDE</b> , tracheal dilators	274
DUROGRIP needle holder	502	<b>LACK</b> , tongue spatulas	119
		Lacrimal duct, dilators for	519

## Alphabetical Index

L – M

	Page		Page
<b>LAHEY</b> , dissecting and ligature forceps	490	<b>LEXER</b> , osteotomes	233
organ and tissue grasping forceps	35	<b>LEXER-MINI</b> , gouges	232
retractors	332	osteotomes	232
<b>LAHEY (SWEET)</b> , dissecting and ligature forceps	490	<b>LICHTENBERG</b> , DUROGRIP needle holder	509
<b>LAMBOTTE</b> , osteotomes	228, 230	Ligature, forceps	435, 458, 475, 477, 484-490
Lamps, replacement	6	forceps, ATRAUMATA	465
<b>LANDOLT</b> , dissecting suction tube	104, 539	instruments	144
enucleation scissors	413	needles	158, 510-512
raspatories	211	scissors	424
scalpel handle	369	scissors, DUROTIP	380, 386, 390
spreading forceps	81	scissors, NOIR	375
tumor grasping forceps	85	scissors, wavecut	375, 386, 390
<b>LANDOLT-REULEN</b> , TREND dissectors	87, 88	Light cable adapters	58
TREND hook	87, 88	Light cables	58, 154
<b>LANE</b> , tissue forceps	453	Light guide adapters	58
<b>LANGE</b> , fistula hook	307	Light guides	58, 154
raspatory	207	<b>LISTER</b> , bandage and cloth scissors	425, 426
<b>LANGENBECK</b> , bone holding forceps	252	sinus forceps	343
DUROGRIP needle holder	508	<b>LISTON</b> , bone cutting forceps	249
elevators	201	<b>LITTLER</b> , delicate dissecting scissors	412
raspatories	213, 214	<b>LOCKLIN</b> , delicate scissors	405
retractors	326	<b>LOCKWOOD</b> , organ and grasping forceps	496
rib raspatories	214	Loops, ear	10
<b>LANGENBECK-GREEN</b> , retractors	305	wire	13, 114, 143
<b>LANGENBECK-MANNERFELT MODIF</b> , retractors		<b>LOPEZ-REINKE</b> , tonsil dissector	539
with triangle handle	303	<b>LORNA</b> , towel clamps	353
Laryngeal, instruments, handle for	159	Lower lateral scissors	413
micro biopsy forceps	157	<b>LOWER</b> , dissecting and ligature forceps	490
micro cup forceps	156, 157	<b>LUBET</b> , nasal tampon forceps	92
micro forceps	155	<b>LUC</b> , septum forceps	71
micro grasping forceps	156	<b>LUCAE</b> , dissecting forceps, bayonet-shaped	442
micro knives	158	ear levers	12
micro scissors	156	paracentesis needles	9
micro separators	158	tuning forks	7
micro suture guide	158	<b>LUCAS</b> , bone curettes	219
mirrors	152	chisels	227
needle holders	157	ERGOPLANT bone curettes	218
polypus forceps	160	gouges	227
sickle knives	158	<b>LUER</b> , bone rongeurs	244, 245
Laryngectomy scissors	161	retractors	314
Laryngoscopes, holder	153	<b>LUER-FRIEDMANN</b> , bone rongeurs	243
operating	153	ERGOPLANT rongeurs	244
<b>LATHEBURY-FARRELL</b> , cotton applicators	520-522	Lupus spatulas	98
<b>LAZAR</b> , micro suture tying forceps	177		
<b>LELOND-JONES</b> , ATRAUMATA clamps	467		
<b>LEMPERT</b> , bone curettes	221		
bone rongeurs	246		
raspatories	38, 208		
suction cannulas	534		
<b>LERICHE</b> , delicate hemostatic forceps	473		
Levers, ear	10, 12		
<b>LEWIS</b> , bone rasps	240		
<b>LEXER</b> , dissecting scissors	420		
DUROTIP dissecting scissors	383, 386		
gouges	233		
NOIR dissecting scissors	379		
		<b>M</b>	
		<b>MAC DONALD</b> , raspatories	100
		<b>MAGAUAN</b> , bipod	134
		<b>MAGILL</b> , catheter introducing forceps	355
		suction cannulas	536
		<b>MAIER</b> , sponge and dressing forceps	346
		Mallets	42, 235-237
		spare discs	235-237
		<b>MALTZ</b> , bone rasps	240

## Alphabetical Index

## M

	Page		Page
<b>MANNERFELT MODIF.</b> , forked hook with treangle handle	300	Micro, dissectors	37
gouges	223	flap knives	32
osteotomes	223	footplate hooks	29
raspatories	207	forceps	83, 180
retractors with treangle handle	300, 301, 303	forceps, ATRAUMATA	180
saddle hook with treangle handle	304	forceps, ERGOPLANT	180
<b>MARBURG MODELL</b> , wire bending pliers	267	forceps, jeweler patterns	176
<b>MARQUARDT</b> , bone rongeurs	247	hooks	27, 28, 30, 158
<b>MARTINI</b> , bone curettes	216	knives	31
<b>MASING</b> , cartilage slitting knives	97	knives, laryngeal	158
DUROGRIP needle holder	501	laryngeal biopsy forceps	157
elevators	99, 203	laryngeal cup forceps	156, 157
osteotomes	105	laryngeal grasping forceps	155
vein retractors	309	laryngeal scissors	156
<b>MATHIEU</b> , DUROGRIP needle holder	509	needle holders	181-184
retractors	320	needle holders, Dia Dust	185-189, 507
<b>MAYFIELD</b> , bone rongeurs	247	needle holders, Dia Dust, TITANIUM	166, 167
<b>MAYO</b> , dissecting scissors	418, 419, 421	needle holders, DUROGRIP	190, 191
DUROTIP dissecting scissors	382, 386	needles	25
NOIR dissecting scissors	378	perforators	26
Supercut dissecting scissors	394	raspatories	36-38
surgical scissors	418	round cutting knives	33-35, 158
<b>MAYO-LEXER</b> , dissecting scissors	420	scalpel handles	368, 369
DUROTIP dissecting scissors	383, 387	scalpels	362
NOIR dissecting scissors	379	scissors	14, 15, 65, 83, 84, 168-175
<b>MAYO-STILLE</b> , dissecting scissors	418, 419	scrapers	30
surgical scissors	418	separators, laryngeal	158
<b>MC CLURE</b> , micro scissors	168	suction cannula	532
<b>MC INDOE</b> , bone cutting forceps	250	suture guide, laryngeal	158
chisels	108	suture tying forceps	177, 178
delicate dissecting forceps	431	tissue forceps, Dia Dust	180
delicate tissue forceps	449	vein scissors	170
skin hooks	295	vessel dilators	179
<b>MC IVOR</b> , frame for tongue depressors	125	<b>MICRO-ADSON</b> , delicate dissecting forceps	429
tongue spatulas	130	delicate tissue forceps	445, 446
<b>MC KENTY</b> , raspatories	208	dissecting and ligature forceps	484
<b>MC KISSOCK</b> , raspatories	214	TITANIUM delicate dissecting forceps	428
<b>MEAD</b> , bone rongeurs	246	TITANIUM delicate tissue forceps	428
mallets	235	<b>MICRO-ADSON-BIEMER</b> , delicate tissue forceps	445
Measuring instruments	39	<b>MICRO-HALSTED</b> , delicate hemostatic forceps	470
<b>MEHDORN</b> , clip applying forceps	193	Microsurgical blades	369
vessel clips	192	<b>MIDDELDORPF</b> , retractors	334
<b>METZENBAUM</b> , delicate dissecting scissors	398	<b>MIKULICZ</b> , hemostatic forceps	483
dissecting scissors	422	organ and tissue forceps	491
DUROTIP dissecting scissors	385, 388, 389	tonsil forceps	483
NOIR delicate dissecting scissors	377, 378	<b>MILLER</b> , bone curettes	216
NOIR dissecting scissors	376-378	bone rasps	241
Supercut dissecting scissors	395	ERGOPLANT bone rasps	241
<b>MEYERDING</b> , retractors	306	grasping forceps	16
Micro, approximators	194	<b>MILLES</b> , micro scissors	171
bone mill, ERGOPLANT	110	<b>MINOP TREND</b> , adapter	63
bone mill kit	111	irrigation/suction handles	63
crurotomy scissors	15	irrigation/suction shafts	64
cup forceps	19, 20	irrigation/suction tubes	63
dissecting forceps, Dia Dust	180	scopes	64
dissecting scissors	171	storage tray	63

## Alphabetical Index

M – O

	Page		Page
Mirror handles	152	Needle holders, DUROGRIP, micro	190, 191
Mirrors, laryngeal	152	laryngeal	157
nasal	96	micro	181-184
MIXTER, dissecting and ligature forceps	490	micro, Dia Dust	185-189, 507
MIXTER-O'SHAUGNESSY, dissecting and ligature forceps	488	micro, Dia Dust, TITANIUM	166, 167
Mobilisators, stapes	31	micro, DUROGRIP	190, 191
MODELL PICCOLO, cotton applicators	520	TITANIUM	166, 167, 507
MOLLISON, self-retaining retractors	284	with scissors, DUROGRIP	504
tonsil dissector	139	Needles, guide	523
MOLT, mouth gags	121	ligature	158, 510-512
raspatories	205	micro	25
MORITZ-SCHMIDT, tongue depressors	118	paracentesis	9
MORSE, nerve dissecting scissors	406	NEGUS, adenoid curettes	147
Morselizer forceps, cartilage	113	chest support	134
Mouth gags	121, 123, 124	hemostatic forceps	483
Mouth wedge, silicone, ERGOPLANT	122	suction dissector	104, 528
MOYNIHAN, delicate hemostatic forceps	473	suture forks	144
Mucous knives	96	tonsil forceps	483
MUEHLING, bone shears	249	NELATON, directors	516
raspatories	211	NELSON-METZENBAUM, DUROTIP dissecting scissors	389
MUELLER, ligature forceps	458	Nerve, approximators	195
micro needle holders	184	spare needles	195
micro scissors	172	dissecting scissors	415
non-traumatic vessel clips	458	dissecting scissors, delicate	399
skin hooks	295	hooks	290-293
vessel clips	458	NICOLA, micro forceps	83
MURPHY, retractors	325	micro scissors	83
MUSEUX, organ and tissue grasping forceps	135	TREND curettes	86, 88
MUSGROVE, cerumen scoops	10	NISSEN, delicate hemostatic forceps	475
MYLES, conchotomes	70	dissecting and ligature	485
Myringotomes	9	NOIR, bone punches	258-261
Myrtle leaf probes	517	dissecting scissors	375-379
		ligature scissors	375
		pituitary speculum	82
		scissors	375-379
		wavecut scissors	375, 377-379
		Non-traumatic vessel clips	458
<b>N</b>		NORTHBENT, ligature scissors	424
NAGER, tonsil forceps	140	NOYES, micro scissors	168
Nail scissors	400	Nurse's scissors	425
Nasal, forceps	73, 94	Nystagmus glasses	6
fracture elevators	113		
hook	103		
knives	97, 98		
mirrors	96		
pharyngeal forceps	150		
polypus snares	114		
probes	519		
retractors	103		
saws	99		
scissors	65, 90, 91		
speculas	50-59		
suction tubes	536		
tampon forceps	92, 93		
Needle holders, Dia Dust, micro	185-189, 507		
Dia Dust, micro, TITANIUM	166, 167		
DUROGRIP	266, 500-509		
		<b>O</b>	
		OBWEGESER, awls	239
		chisels	233
		raspatories	212
		retractors	329, 330
		OBWEGESER-FREER, elevators	203
		OCHSNER, ligature forceps	435
		OFFICER, tissue forceps	453
		Oil, spray, STERILIT	551-553
		STERILIT	234, 552, 553
		OLDBERG, rongeurs	85



## Alphabetical Index

R – S

	Page		Page
<b>RAMSEY</b> , dissecting forceps	435	<b>ROSEN</b> , micro flap knives	32
<b>RANKIN</b> , delicate hemostatic forceps	474	micro needles	25
Raspatories	38, 39, 100, 101, 202, 205, 207-215	<b>ROSER-KOENIG</b> , mouth gags	123
micro	36-38	Round cutting knives	158
rib	214, 215	micro	33-35
suction	104	Round files	234
Rasps, antrum	79	Round knives	35
bone	240, 241	<b>ROUX</b> , retractors	317, 319
bone, DUROGRIP	99, 242	<b>ROWBOTHAM</b> , suction cannulas	536
bone, ERGOPLANT	241	Rulers	356
diamond	240	<b>RUSKIN</b> , bone rongeurs	247
DUROGRIP	99, 242	<b>RUSKIN-LISTON</b> , bone cutting forceps	250
Reamers	239	<b>RUSS. MODELL</b> , tissue forceps	454
Rectal probes	516, 518	<b>RUSSEL-DAVIS</b> , tongue spatulas	127, 128
<b>REDON</b> , guide needles	523	<b>RYDEL-SEIFFER</b> , tuning forks	7
<b>REILL</b> , micro needle holders	182	<b>RYDER</b> , Dia Dust micro needle holder	507
reposition forceps	254	DUROGRIP needle holder	506
wire cutting pliers	271	TITANIUM Dia Dust needle holder	507
Removing forceps, applying forceps	459		
Replacement lamps	6	<b>S</b>	
Reposition forceps	254	Saddle hooks, with treangle handle	304
Retractors	103, 305, 306, 312-337	Safety scalpels, single use	358, 359
alar	102	Salival scissors	404
antrum	78, 331	<b>SAROT</b> , DUROGRIP needle holder	503
bone	322, 323	<b>SAUERBRUCH</b> , retractors	332
carotid	279	rib shears	251
dura	294, 297	Saws, nasal	99
femur	285	Scalpels, blades	366, 367
fine	294, 296, 297	microsurgical	369
nasal	103	handles	363-365, 368, 369
self-retaining	275-284, 289	disposable	360-362
skin	285, 297	micro	362
thyroid	287	safety, single use	358, 359
tongue, ERGOPLANT	120	<b>SCHEDE</b> , bone curettes	220
tracheal	298-299	<b>SCHINK</b> , skin grafting knives	115
vein	309-311	<b>SCHMIEDEN</b> , guide probes	513
with treangle handle	300, 301, 303, 304	<b>SCHNIDT</b> , hemostatic forceps	483
<b>REYNOLDS</b> , delicate dissecting scissors	416	tonsil forceps	483
<b>REYNOLDS-JAMESON</b> , delicate dissecting scissors	399	<b>SCHOENBORN</b> , vein retractors	311
Rib, holding forceps	253	<b>SCHUHKNECHT</b> , micro round cutting knives	35
raspatories	214, 215	suction cannulas	535
shears	251	<b>SCHWARTZ</b> , clip forceps	198
<b>RITTER</b> , frontal sinus bougies	80	vessel clips	198
<b>RNTNE-HOSPITAL</b> , self-retaining retractors	282	<b>SCHWECKENDICK</b> , tonsil scissors	141
<b>ROBIN</b> , towel clamps	352	<b>SCHWEDISCHES MODELL</b> , dissecting forceps	435
<b>ROCHESTER-CARMALT</b> , hemostatic forceps	482	Scissors, anatomy	404
<b>ROCHESTER-OCHSNER</b> , hemostatic forceps	480	arteriotomy	416
<b>ROCHESTER-PEAN</b> , hemostatic forceps	479	bandage	425, 426
<b>ROEDER</b> , ligature instruments	144	bulldog	412
towel clamps	351	cartilage	417
<b>ROLLET</b> , skin hooks	294	cloth	425, 426
Rongeurs	72-76, 85	crurotomy	15
bone	243-247	delicate	397-406, 412
ERGOPLANT	244		
<b>ROSE</b> , retractors	314		
<b>ROSEN</b> , ear speculas	4, 5		

## Alphabetical Index

## S

	Page		Page
Scissors, delicate, dissecting	398, 399, 406, 412-417	<b>SELMAN</b> , tissue forceps	454
delicate, DUROTIP	380, 383-388	<b>SEMB</b> , bone holding forceps	253
delicate, NOIR	375, 377-379	rib holding forceps	253
delicate, wavecut	375, 377-379, 386-388	<b>SEMKEN</b> , delicate dissecting forceps	431
dissecting	406, 412, 418-422	delicate tissue forceps	448
dissecting, delicate	398, 399, 412-417	<b>SENN-MILLER</b> , retractors	312
dissecting, DUROTIP	382-389	Separators, laryngeal micro	158
dissecting, micro	171	Septum, forceps	71, 95, 112
dissecting, NOIR	375-379	gouges	105, 107
dissecting, Supercut	394-396	nives	98
dissecting, wavecut	375, 377-379, 386-389	scissors	91
DUROTIP	268, 380-390	speculas	57
enucleation	413	Sets, suction	43, 526
eye	169	<b>SEWALL</b> , elevators	202
incision	411	raspatories	202
iris	397, 400	Shafts, irrigation/suction, MINOP TREND	64
laryngectomy	161	<b>SHAMBAUGH</b> , micro hooks	27, 28
ligature	424	<b>SHEA</b> , curettes	40
ligature, DUROTIP	380, 386, 390	ear speculas	5
ligature, NOIR	375	Shears, bone	249
ligature, wavecut	375, 386, 390	rib	251
lower lateral	413	Sickle knives	9, 77
micro	14, 15, 65, 83, 84, 168-175	laryngeal	158
micro laryngeal cup	156	Silicone mouth wedge, ERGOPLANT	122
micro, dissecting	171	Silicone pads	125
micro, vein	170	Silicone tubes, spare	121
nail	400	<b>SILVER</b> , skin grafting knives	115
nasal	65, 90, 91	<b>SIMON</b> , fistula hook	307
nerve	399, 406	<b>SIMS-MAIER</b> , sponge and dressing forceps	347
nerve dissecting	415	Single use, safety scalpels	358, 359
NOIR	375-379	scalpels	360, 362
nurse's	425	Sinus, forceps	343
salival	404	probes	518
septum	91	punches	66
strabismus	398	Sinuscopy trocar	80
Supercut	392, 393	Skin, grafting knives	115
Supercut-, delicate	392	hooks	294-297
surgical	407-411, 418	retractors	285
surgical, DUROTIP	381, 382	<b>SLUDDER-BALLENGER</b> , tonsillotome handle	145
tendon	414	tonsillotomes	145
tonsil	141	Snare wires	143
vascular	414, 423	Snares, ear	13
vein, micro	170	nasal polypus	114
wavecut	375, 377-379, 386-390	tonsil	142, 144
wire	268	<b>SNELLEN</b> , ear loop	10
wire cutting	268, 269	Spare, blades, dermatomes	115
wire cutting, DUROTIP	268	discs, mallet	235-237
Scoops, cerumen	8, 10	needles, nerve approximator	195
Scopes	64	silicone tubes	121
Scrapers, micro	30	Spatulas, lupus	98
<b>SEBILEAU</b> , elevators	201	tongue	118-120, 127-133, 520
<b>SEDILLOT</b> , raspatories	213	Speculas, ear	2-5
Seeker, frontal sinus ostium	80	nasal	50-59
<b>SEIFFERT</b> , probes	519	pituitary	81, 82
<b>SELDIN</b> , raspatories	205	pituitary, NOIR	82
Self-retaining retractors	275-284, 289	septum	57



## Alphabetical Index

S – T

	Page		Page
<b>SPENCER</b> , ligature scissors	424	Suction, tubes, dissecting	104, 539
<b>SPENCER-WELLS</b> , hemostatic forceps	478	tubes, MINOP TREND	63
Splinter forceps	455	tubes, nasal	535
Sponge, forceps	342-347	Supercut, delicate scissors	392
holding forceps	348, 497	dissecting scissors	394-396
Spray, oil, STERILIT	551-553	scissors	392-396
Spreaders	82	Supports, ear specula	6
glomus	286	chest	134
Spreading forceps	81	Surgical scissors	407-411, 418
<b>ST. BARTS</b> , ear hooks	12, 288	DUROTIP	381, 382
rongeurs	74, 75	Suture, forceps, DUROGRIP	441
<b>ST. CLAIR-THOMPSON</b> , adenoid curettes	148	forks	144
nasal speculas	50	guide, laryngeal micro	158
<b>ST. MARTIN</b> , delicate tissue forceps	445	tying forceps	177, 178
eye forceps	445	tying forceps, micro	177, 178
<b>STACKE</b> , ear probe	519	Swivel knives	96
<b>STAMM</b> , bone cutting forceps	248	<b>SYME</b> , raspatories	205
<b>STAMMBERGER</b> , antrum punches	67	tonsil dissector	139
<b>STANDARD</b> , DUROGRIP dissecting forceps	441	Syndesmotomes	202
Stapes, elevators	36	Syringes	541-543
mobilisators	31		
<b>STELLBRINK</b> , bone rongeurs	243		
Sterile, drape for UNITRAC arm	61	<b>T</b>	
scalpels	358-362	<b>TAKAHASHI</b> , rongeurs	75, 76
STERILIT, oil	234, 552, 553	Tampers	238
oil spray	551-553	Tampon forceps, ear	24
<b>STERNBERG</b> , retractors	313	nasal	92, 93
<b>STEVENS</b> , delicate dissecting scissors	398, 414	Teeth protector	154
Supercut scissors	392	Tendon hooks	308, 309
vascular and tendon scissors	414	Tendon passing probes	517
Stich cutters	367	Tendon scissors	414
<b>STIEGLITZ</b> , splinter forceps	455	<b>TESSIER</b> , osteotomes	226
<b>STILLE</b> , chisels	230	Test strips	234
dissecting scissors	420	<b>THOREK</b> , vascular scissors	423
gouges	231	<b>THORPE</b> , corneal forceps	429
osteotomes	231	delicate dissecting forceps	429
<b>STILLE-BARRAYA</b> , vascular and tumor forceps	454	Thyroid, hook	311
Stitch cutters	367	retractors	287
Storage, racks	45	<b>TIECK-HALLE</b> , nasal speculas	52, 57
tray, MINOP TREND	63	<b>TILLEY</b> , ear tampon forceps	24
Strabismus scissors	398	nasal tampon forceps	92
<b>STRANDELL-STILLE</b> , tendon hook	309	<b>TILLEY-LICHTWITZ</b> , antrum trocars	79
<b>STRASSBURGER MODELL</b> , tissue forceps	454	Tissue forceps	447, 450-454
Strips, test	234	delicate	431, 445, 446, 448, 449
<b>STRUYCKEN</b> , conchotomes	70	Dia Dust	180
Suction, adapter	44	ERGOPLANT	428
cannulas	43, 44, 527-538, 540	micro, Dia Dust	180
cannulas, Fukushima design	531	Tissue, grasping forceps	135, 348, 492-497
cannulas, micro	532	grasping forceps, ATRAUMATA	495
dissectors	104, 538	pick	297
handles	43	forceps	451-454
MINOP TREND	63	<b>TITANIUM</b> , ATRAUMATA dissecting forceps	437
raspatories	104	ATRAUMATA vessel clamp	468, 469
sets	43, 526	delicate dissecting forceps	428, 431
shafts, MINOP TREND	64		
tubes	526		

## Alphabetical Index

## T – W

	Page		Page
TITANIUM, delicate tissue forceps	428	TUDICHUM, nasal speculas	50
dissecting forceps, delicate	428, 431	TUFFIER, organ and tissue grasping forceps	492
Dia Dust micro needle holders	166, 167	TUMARKIN, ear speculas	4
needle holder	507	Tumor, forceps	454
tissue forceps, delicate	428	grasping forceps	85
TOBOLD, tongue spatulas	120	Tuning forks	7
TOENNIS, delicate dissecting scissors	417	Twisters, wire, DUROGRIP	266
dura retractors	294	TYDING, tonsil snares	144
DUROGRIP needle holder	508		
TOENNIS MODIF., DUROGRIP needle holder	508	<b>U</b>	
TOENNIS-ADSON, delicate dissecting scissors	416	UFFENORDE, bone curettes	220
DUROTIP dissecting scissors	384, 387	ULRICH-AESCULAP, sponge and dressing forceps	345
NOIR dissecting scissors	377	Ultra light forceps, ATRAUMATA	436
Tongue, depressors	118	UNITRAC, arm, sterile drape	61
depressors, frame for	125, 126	CO <sub>2</sub> air cartridge	60
forceps	117, 497	CO <sub>2</sub> air cartridge adapter	60
retractor, ERGOPLANT	120	couplings	61
spatulas	118-120, 127-133, 520	holding arm	60
Tonsil, dissectors	138, 139, 539	Universal trocars	80
forceps	136, 137, 140, 483	US-ARMY, retractors	321
knives	140		
punches	145	<b>V</b>	
scissors	141	VANNAS, micro scissors	168, 170, 171
snares	142, 144	Vascular, forceps	454
Tonsillotomes	145	scissors	414, 423
handle	145	Vein, hooks	291
Towel clamps	351-354	retractors	309-311
TOYNBEE, ear speculas	3	VERHOEVEN, suction cannulas	44, 527
Tracheal, dilators	274	Vessel, clamp, ATRAUMATA TITANIUM	468, 469
retractors	298, 299	clips	192, 196, 198, 458
Transplant carriers	36	clips, non-traumatic	458
Trays, preparation	39	dilators, micro	179
storage, MINOP TREND	63	hooks	12, 290-293
TRELAT, raspatories	209	VIDAL, lupus spatula	98
TREND, curettes	86-88	VISE, micro suture tying forceps	177
curettes, deflectable	86	VOLKMANN, bone curettes	221
dissectors	87, 88	bone retractors	322, 323
dissectors, deflectable	86	retractors	322, 324
enucleators	86, 88		
hook	87, 88	<b>W</b>	
knife, deflectable	86	WAGENER, ear hooks	12
Trocars, antrum	79	nerve- and vessel hooks	290
sinuscopy	80	WALSHAM, septum forceps	112
universal	80	WALTER, chisels	108
TROELTSCH, dissecting forceps, angular	444	gouges	231
TROUSSEAU, tracheal dilators	274	osteotomes	107
Tubes, dissecting, suction	104, 539	retractors	103
irrigation/suction, MINOP TREND	63		
nasal suction	535		
spare silicone	121		
suction	526		
suction, dissecting	104, 539		
suction, nasal	535		
Tubing, clamps	349, 350		
forceps	342, 478		
Tubular shaft forceps	155		

## Alphabetical Index

W – Z

	Page		Page
WANGENSTEEN, DUROGRIP dissecting forceps	441	<b>Z</b>	
WARD, raspatories	209	ZAUFAL, ear levers	10
WATSON-CHEYNE, raspatories	100, 206	ZAUFAL-JANSEN, bone rongeurs	247
WATSON-WILLIAMS, rongeurs	76	ZENKER, retractors	337
WAUGH, delicate tissue forceps	449	ZOELLNER, suction cannulas	43, 44, 527, 528
Wavecut scissors	375, 377-379, 386-390		
WEBER, ear loops	10		
WEBSTER, DUROGRIP needle holder	501		
WEDER, tongue spatulas	119		
WEIL-BLAKESLEY, rongeurs	72		
WEITLANER, self-retaining retractors	277-279		
WEST, nasal tampon forceps	92		
WHITE, tonsil forceps	136		
WHITEHEAD, mouth gags	124		
WHITEHEAD-JENNINGS, mouth gags	124		
WIENER MODELL, nasal speculas	53, 54		
WIKSTROEM, dissecting and ligature forceps	488		
WILDE, dissecting forceps, angular	444		
nasal polypus snares	114		
WILDER, dilators for lacrymal duct	519		
WILLIGER, bone curettes	221		
elevators	200		
raspatories	209		
WILSON, hemostatic forceps	483		
tonsil forceps	483		
Wire, bending forceps	23		
bending pliers	267		
cutters	270, 271		
cutting pliers	271		
cutting pliers , lateral cutting action	271		
cutting scissors	268, 269		
cutting scissors, DUROTIP	268		
holding forceps, DUROGRIP	266		
loops	13, 114, 143		
scissors	268		
twisters, DUROGRIP	266		
Wires, snare	143		
WULLSTEIN, micro needle	25		
raspatories	38		
self-retaining retractors	278		
<b>Y</b>			
YANKAUER, suction cannulas	537		
YASARGIL, arachnoid blades	369		
clamping arm	6		
micro forceps	83		
micro scissors	171		
rongeurs	85		

## Alphabetischer Index

## A – B

	Seite		Seite
<b>A</b>			
Abnehmezangen, Bulldogklemmen	459	Antrumtrephine	79
<b>ABRAHAM</b> , Tonsillenfasszangen	137	Antrumtrokare	79
Tonsillennmesser	140	Applikationsinstrumente	31
Abwinkelbare TREND Kürette	86	Approximatoren	195, 196
Abwinkelbarer TREND Dissektor	86	Mikro-	194
Abwinkelbares TREND Messer	86	Nerv-	195
<b>ACLAND</b> , Approximatoren	196	Arterienfasszangen	135
Clip-Anlegepinzetten	197	Arterienklemmen	342, 478–483, 496
Gefäßclips	196	Feine-	470–477
Adapter, Kaltlichtkabel-	58	Arteriotomiescheren	416
Kartuschen-, UNITRAC	60	<b>ASH</b> , Septumrichtzangen	112
MINOP TREND	63	<b>ATRAUMATA</b> , Bulldogklemmen	461–463
Saug-	44, 528	Coarctationsklemmen	466
Adenotome	149	Gefäßklemmen TITANIUM	468, 469
Adenotomklingen	149	Gewebefasszangen	495
<b>ADLERKREUTZ</b> , Chirurgische Pinzetten	454	Klemmen	464, 466, 467
<b>ADSON</b> , Arterienklemmen	475, 476	Ligaturklemmen	465
Chirurgische Pinzetten	447	Organfasszangen	495
DUROGRIP atraumatische Pinzetten	440	Patent-Ductusklemmen	467
Feine anatomische Pinzetten	429	Peripheralklemmen	467
Feine chirurgische Pinzetten	445, 446	Pinzetten	438, 439
Nerv- und Gefäßhäkchen	292	Pinzetten, Mikro-	180
Pinzetten, bajonettförmig	442	Pinzetten, TITANIUM	437
Raspatorien	208, 212	Präparierklemmen	465
Saugkanülen	529	Atraumatische Gefäßclips	458
TITANIUM Feine anatomische Pinzetten	428	Atraumatische Pinzetten, DUROGRIP	440
<b>ADSON-BABY</b> , Wundspreizer	282	ERGOPLANT	180, 428, 436
<b>ADSON-BROWN</b> , Chirurgische Pinzetten	447	Ultra-Light	436
<b>AESCULAP</b> , Instrumenten Organisations System	46–47	<b>AUFRICHT</b> , Knochenraspeln	240
Korn- und Tupferzangen	345	Nasenretractor	103
Mikro-Knochenmühle Kit	111	Aufrichter, Nasenfraktur-	113
Waschzangen	345	Augenpinzetten	445
Ahle, Knochen-	239	Augenscheren	169
Ahlen	239	Augensonden	519
<b>ALEXANDER</b> , Hohlmeißel	227	<b>AUSTIN</b> , Mikro-Knüpfpinzetten	177
Hohlmeißelzangen	246		
<b>ALLENBERG</b> , Carotissperrer	279	<b>B</b>	
<b>ALLIS</b> , Atraumatische Organ- und Gewebefasszangen	495	<b>BABCOCK</b> , Organ- und Gewebefasszange	494, 495
Organ- und Gewebefasszangen	493	<b>BABY-ADSON</b> , Präparier- und Ligaturklemmen	485
<b>ALLIS-ADAIR</b> , Organ- und Gewebefasszangen	492	<b>BABY-ALLIS</b> , Organ- und Gewebefasszangen	492
<b>ALLIS-THOMS</b> , Organ- und Gewebefasszange	494	<b>BABY-CRILE (KOCHER)</b> , Arterienklemmen	472
<b>ALLPORT</b> , Wundspreizer	276	<b>BABY-CRILE (PEAN)</b> , Arterienklemmen	472
Anatomische Mikro-Pinzetten, Dia Dust	180	<b>BABY-CRILE-WOOD</b> , DUROGRIP Nadelhalter	502
Anatomische Pinzetten	434, 435	<b>BABY-METZENBAUM</b> , DUROTIP Präparierscheren	384, 387
Feine-	429–433	NOIR Feine Präparierscheren	376
<b>ANGLE</b> , Drahtschneidezangen	270	Präparierscheren	422
Anlegepinzetten, Clips	197	Supercut Präparierscheren	395
Anlegezangen, Bulldogklemmen	459	<b>BABY-MIKULICZ</b> , Peritoneumklemmen	491
Clips	198	<b>BABY-MIXTER</b> , Präparier- und Ligaturklemmen	484
Antrumahäkchen	30	<b>BABY-MOSQUITO (HARTMANN)</b> , Arterienklemmen	470
Antrumahaken	78, 331	<b>BABY-OVERHOLT</b> , Präparier- und Ligaturklemmen	484
Antrumküretten	78	<b>BABY-ROUX</b> , Wundhaken	314
Antrumlöffel	77	<b>BABY-SENN-MILLER</b> , Wundhaken	312
Antrumstanzen	66, 67		



## Alphabetischer Index

## C – D

	Seite		Seite
Clip-Anlegepinzetten	193, 194, 197	CUSHING-LANDOLT, Hypophysenspekula	81
Clip-Anlegezangen	198	CZERNY, Organ- und Gewebefasszangen	135
Clips, Atraumatische Gefäß-	458	Wundhaken	320
Gefäß-	192, 196, 198, 458		
Gefäß-, atraumatische	458	<b>D</b>	
CO <sub>2</sub> , Druckluftkartusche	60	DANDY, Arterienklemmen	471
Kartuschenadapter, UNITRAC	60	DAUBENSPECK, Scharfe Löffel	222
COAKLEY, Antrumküretten	78	DAUTREY, Osteotome	227
Coarctationsklemmen, Atraumatische-	466	DAVIES-BOYLE, Bügel für Zungenspatel	126
COLLER, Feine Arterienklemmen	474	Zungenspatel	131
COLLIN, Atraumatische Organ- und Gewebefasszangen	495	DAVIES-MEYER, Bügel für Zungenspatel	125
Organ- und Gewebefasszangen	496, 497	DE BAKEY, Arteriotomiescheren	416
Tupfer- und Schwammzangen	497	Atraumatische Bulldogklemmen	462
Wundhaken	316	Atraumatische Coarctationsklemmen	466
Zungenzangen	497	Atraumatische Klemmen	466, 467
COLLIN-HARTMANN, Wundhaken	313	Atraumatische Peripheralklemmen	467
Collumela Klemme	113	Atraumatische Pinzetten	438, 439
COLVER, Tonsillenfasszangen	136	Atraumatische Präparier- und Ligaturklemmen	465
Conchotome	70	Atraumatische Ultra-Light-Pinzetten	436
CONVERSE, DUROGRIP Nadelhalter	501	DUROGRIP Nadelhalter	505
Plastikmesser	98	Saugkanülen	536, 537
COOLEY, Atraumatische Klemmen	464	TITANIUM Atraumatische Gefäßklemmen	468, 469
Atraumatische Pinzetten	439	TITANIUM Atraumatische Pinzetten	437
Feine anatomische Pinzetten	433	Wundspreizer	285
Gefäßscheren	423	DE BAKEY-HESS, Bulldogklemmen	460
COOPER, Chirurgische Scheren	409	DEAN, Tonsillenscheren	141
COTTLE, Bulldog-Scheren	412	DEAVER, Chirurgische Scheren	411
Elevatorien	99, 101, 203	DENHARDT, Mundsperrer	123
Fischschwanzosteotom	106	DENIS-BROWNE, Tonsillenfasszangen	137
Fixierpinzetten	113	DERF, DUROGRIP Nadelhalter	500
Hämmer	235	Dermatome, Hand-	115
Hauthäkchen	295	DERRA, Atraumatische Klemmen	464
Nasenflügelretractor	102	DESCHAMPS, Unterbindungsadeln	510-512
Nasenscheren	91	DESMARRES, Wund- und Venenhaken	309
Nasenspekula	56	Dia Dust, Anatomische Mikro-Pinzetten	180
Osteotome	106	Chirurgische Mikro-Pinzetten	180
Raspatorien	99, 101, 211	Mikro-Nadelhalter	185-189, 507
Septummesser	98	Mikro-Nadelhalter, TITANIUM	166, 167, 507
Septumrichtzangen	112	Mikro-Pinzetten, Anatomische	180
Septumspekula	57	Mikro-Pinzetten, Chirurgische	180
Wund- und Venenhaken	309	Nadelhalter, Mikro-	185-189, 507
COTTLE-KNAPP, Feine Präparierscheren	413	Nadelhalter, Mikro-, TITANIUM	166, 167, 507
COTTLE-MASING, Feine Präparierscheren	413	Diamant, Messer	371
CRAIG, Septumzangen	95	Raspel	240
CRAIG-DOMNICK, Septumzangen	95	DIEFFENBACH, Bulldogklemmen	459
CRILE, Arterienklemmen	472, 474	DIETER, Hammerkopfstanzanzen	23
Nerv- und Gefäßhäkchen	291	DIETHRICH, Bulldogklemmen	460
Wundhaken	315	Dilatatoren, Mikro-Gefäß-	179
CRILE-WOOD, DUROGRIP Nadelhalter	502	Stirnhöhlen-	80
Crurotomieschere, Mikro-	15	Tracheal-	274
CUSHING, Chirurgische Pinzetten	450	Tränenkanal-	519
DUROGRIP Pinzetten	441	DINGMANN, Knochenhalte-zangen	253
Feine anatomische Pinzetten	432	Mundsperrer	124
Nerv- und Gefäßhäkchen	291, 293		
Wund- und Venenhaken	311		
CUSHING-KOCHER, Wund- und Venenhaken	310		

## Alphabetischer Index

## D – F

	Seite		Seite
<b>DINGMANN MODIF.</b> , Knochenhaltezangen	253	<b>E</b>	
Dissektoren, Mikro-	37	<b>EAST GRINSTEAD (WARD)</b> , Flachmeißel	230
Saug-	104, 538	Osteotome	230
Tonsillen-	138, 139, 539	<b>EICKEN</b> , Spülröhrchen	79
<b>TREND</b>	87, 88	Einlage, Silikon-	125
<b>TREND</b> , abwinkelbar	86	Einmalskalpelle	360-362
<b>DIXON-LOVELACE</b> , Arterienklemmen	475	Sicherheits-	358, 359
<b>DOCKHAM</b> , Wundhaken	336	Elevatoren	99-101, 200-203
Doppelinstrument, Stirnhöhlen-	80	Knochendeckel-	200
Doppelknopfsonden	518	Stapes	36
<b>DOUGHTY</b> , Zungenspatel	132	<b>EMMET</b> , Fistelhaken	307
<b>DOYEN</b> , Hohlsonden	516	Endoskope	64
Raspatorien	215	E nukleationsscheren	413
Rippenraspatorien	215	E nukleatoren, <b>TREND</b>	86, 88
<b>DOYEN-COLLIN</b> , Mundsperrler	121	<b>ERGOPLANT</b> , Atraumatische Pinzetten	428
<b>DOYEN-JANSEN</b> , Mundsperrler	121	Chirurgische Pinzetten	428
<b>DRAFFIN</b> , Mundsperrlerhalter	134	<b>DUROGRIP</b> Pinzette	428
Draht- und Blehscheren	268, 269	Hohlmeißelzangen	244, 248
<b>DURROTIP</b>	268	Klingenhalter	368
Drahtbiegezangen	23, 267	Knochenfeilen	241
Drähte, Schnür-	143	Knochensplitterzange	248
Drahtfasszangen, <b>DUROGRIP</b>	266	Mikro-Knochenmühlen	110
Drahtscheren	268, 269	Mikro-Pinzette	180
<b>DURROTIP</b>	268	Mundkeile, Silikon-	122
Drahtschlingen	13, 114, 143	Pinzetten, Atraumatische-	428
Drahtschneidezangen	270, 271	Pinzetten, Chirurgische-	428
<b>DURROTIP</b>	270	Pinzetten, <b>DUROGRIP</b> -	428
Drahtspannzangen, <b>DUROGRIP</b>	266	Pinzetten, für Weichgewebe	428
Drücker, Zungen-	118	Pinzetten, Mikro-	180
Druckkartusche, CO <sub>2</sub> , <b>UNITRAC</b>	60	Reiniger für Knochenmühle	110
Ductusklemmen, Atraumatische-	467	Scharfe Löffel	218
<b>DUNHILL</b> , Arterienklemmen	472, 477	Schneideplatten	110
Durahäkchen	294, 297	Silikonmundkeile	122
<b>DURHAM</b> , Wundhaken	333	Zungenretraktoren	120
<b>DUROGRIP</b> , Drahtfasszangen	266	Weichgewebepinzette	428
Drahtspannzangen	266	Ersatzbacken, Hämmer	235-237
Fasszangen, Draht-	266	Ersatzklingen, Dermatome	115
Knochenraspeln	99, 242	Ersatzlampen	6
Mikro-Nadelhalter	190, 191	Ersatznadeln, Nerv-Approximator	195
Nadelhalter	500-506, 508, 509	Ersatz-Silikonschläuche	121
Nadelhalter, Mikro-	190, 191	<b>EVES</b> , Tonsillenschnürer	142
Nadelhalter, mit Schere	504	Tonsillenschnürer <b>SUSI</b>	142
Nahtpinzetten	441	Explorationshäkchen	293
Pinzetten	440, 441		
<b>DURROTIP</b> , Blehscheren	268		
Chirurgische Scheren	381	<b>F</b>	
Drahtscheren	268	Fadengabeln	144
Fadenscheren	380, 386	Mikro-	158
Feine Scheren	380	Fadenklemmen	458
Ligaturscheren	380, 386, 390	Fadenmesser, Carbon Steel	367
Präparierscheren	382-385	Stainless Steel	367
Scheren	268, 380-390	Fadenpinzetten	435
Scheren mit Wellenschliff	386-390	Fadenscheren, <b>DURROTIP</b>	380, 386
<b>DUVAL-COLLIN</b> , Organ- und Gewebefasszangen	496		

## Alphabetischer Index

## F – G

	Seite		Seite
Fadenscheren, Feine-, NOIR	375	FOMON, Nasenflügelretractor	102
Mikro-	173	Nasenflügelscheren	413
FAHLBUSCH, Mikro-Schere	83	Nasenscheren	91
FARABEUF, Raspatorien	213	Osteotome	105
Wundhaken	315	Supercut Scheren	393
FARABEUF-COLLIN, Raspatorien	213	FORMBY, Saugkanülen	534
FARRELL, Watteträger	520, 522	Zerumenlöffel	8
Fasszängchen	16-20, 84	FOWLER, Tonsillennmesser	140
Mikro-Larynx-	155	FRAENKEL, Kehlkopfpolypezange	160
Fasszangen	68	Kehlkopfzange	161
Arterien-	135	FRANKFURT, Wundspreizer	289
Atraumatische Gewebe-	495	FRASER-KELLY (CRILE), Arterienklemmen	476
Atraumatische Organ-	495	FRAZIER, Durahäkchen	294
Draht-, DUROGRIP	266	Saugkanülen	533, 534
Gewebe-	135, 492-497	FREER, Elevatorien	100, 202
Gewebe-, Atraumatische	495	Flachmeißel	223
Haken-	135	Hauthäkchen	295
Kieferhöhlen-	69	Hohlmeißel	223
Organ-	135, 492-497	Raspatorien	100, 101, 202, 206, 207
Organ-, Atraumatische	495	Mukosamesser	96
Rippen-	253	FREER-YASARGIL, Raspatorien	100, 206
Tonsillen-	136, 137, 140	Fremdkörperinstrumente	13
Tumor-	85	FRENZEL, Nystagmusbrillen	6
FEILCHENFELD, Splitterpinzetten	455	Zungenspatel	118
Feilen, Knochen-	240	FRIEDMANN, Hohlmeißelzangen	243
Knochen-, ERGOPLANT	241	FUCHSIG, Arterienklemmen	475
Rund-	234	Führungsgabeln	31
Feine anatomische Pinzetten	429-433	Führungs-Hohlsonden	513, 514
Feine Arterienklemmen	470-477	PEEK	514
Feine chirurgische Pinzetten	445-449	Führungsnadeln	523
Feine Fadenscheren, NOIR-	375	Fukushima Design, Saugkanülen	531
Feine Nasenzangen	73	Furunkelmesser	9
Feine Präparierscheren	398, 399, 406, 412-417	Fußplattenhäkchen, Mikro-	29
NOIR	375-379		
Feine Scheren	397-406, 412	<b>G</b>	
DUROTIP	380	Gabelhaken, Treangle-Griff	300
Supercut	392	Gabeln, Faden-	144, 158
FERGUSSON, Knochenhaltezaugen	252	Führungs-	31
Saugkanülen	530, 533	Mikro-	158
FERGUSSON-ACKLAND, Mundsperrerr	123	GALLAHER, Knochenfeilen	240
FERRIS-SMITH, DUROGRIP Pinzetten	441	GAST, Zungenspatel	129
FICKLING, Arterienklemmen	482	Gaumenplatte	125
FINSEN, Wundspreizer	275	Gefäßclips	192, 196, 198, 458
FINSEN MODIF., Wundspreizer	275	Atraumatische-	458
FISCH, Dura- und Hauthäkchen	297	Gefäßdilatoren, Mikro-	179
Fischschwanzosteotom	106	Gefäßhäkchen	12, 290-293
FISHER, Tonsillennmesser	140	Gefäßklemmen, Atraumatische TITANIUM	468, 469
Fistelhaken	307	Gefäßpinzetten	454
Fixierklemmen	352	Gefäßscheren	399, 414, 423
Fixierpinzetten	113	GELPI, Hautspreizer	285
Fixiervorrichtung	6	GEMINI, Präparier- und Ligaturklemmen	487
Flachmeißel	42, 108, 223, 225-227, 230, 232	GERALD, Feine anatomische Pinzetten	431
Flachzangen	267	Feine chirurgische Pinzetten	449
Flexible Verbindungsklemme	60		
FOERSTER-BALLENGER, Tupfer- und Schwammzangen	348		
FOMON, Knochenraspeln	241		



## Alphabetischer Index

## G – H

	Seite		Seite
GERALD, Feine anatomische TITANIUM Pinzetten	431	HAJEK, Osteotome	320
Feine chirurgische TITANIUM Pinzetten	431	Spülkanülen	80
Gewebefasszangen	135, 492-497	HAJEK-KOFLER, Stanzen	256, 257
Atraumatische-	495	HAKANSSON, Hohlmeißelzangen	245
Gewebekralle	297	Häkchen, Antrum-	30
GIERTZ-STILLE, Rippenscheren	251	Dura-	294, 297
GILLIES, DUROGRIP Nadelhalter mit Schere	504	Explorations-	293
Feine anatomische Pinzetten	431	Fußplatten-	29
Feine chirurgische Pinzetten	449	Gefäß-	290-293
Hauthäkchen	296	Haut-	294-297
Osteotome	225	Mikro-	27-30, 158
Saugkanülen	529	Nerv-	290-293
Giraffenzangen	68	Ohr-	12, 288
GLATZEL, Nasenspiegel	96	Tracheal-	298, 299
GLICKMAN, Raspatorium	207	TREND	87, 88
Glomus-Spreizer	286	Venen-	291
GLOVER, Atraumatische Bulldogklemmen	462	Wund-	294-299
GLUCK, Rippenscheren	251	Haken, Antrum-	78, 331
GOELET, Wundhaken	321	Gabel-	300
GOLDMAN-FOX, DUROTIP Feine Scheren	380	Knochen-	322, 323
Supercut Scheren	393	Nasen-	103
GOLDMANN, Nasenfrakturaufrichter	113	Parotis-	308
GOOD, Tonsillenscheren	141	Sattel-	304
GORNEY, Feine Präparierscheren	417	Schilddrüsen-	311
Saugdissektor	104, 538	Sehnenscheiden-	308, 309
Supercut Präparierscheren	396	Venen-	309-311
GOSLEE, Flachzangen	267	Wund-	103, 296, 300-337
GRAEFE, Chirurgische Pinzetten	447	Hakenfasszangen	135
Feine Präparierscheren	412	HALLE, Elevatorien	202
Haut- und Wundhäkchen	294	Raspatorien	202
Nerv- und Gefäßhäkchen	290	Scharfe Löffel	222
GREENE, Wundhaken	334	HALSEY, DUROGRIP Nadelhalter	500, 501
GREGORY, Atraumatische Bulldogklemmen	463	HALSTED, Arterienklemmen	475
GREY-TURNER, Arterienklemmen	477	HALSTED-MOSQUITO, Arterienklemmen	470, 476
Griffe, Hand-	42, 159	Haltearm	62
Saug-	43	UNITRAC	60
Skalpell-	363-365	Haltekloben	62
Skalpell-, Mikrochirurgische Klingen	368, 369	Halter, Laryngoskop-	153
Spiegel-	152	Mundsperrer	134
Spül-/ Saug-, MINOP TREND	63	Ohrspekula-	6
Tonsillotom-	145	Haltezangen, Knochen-	252, 253
GROSS, Korn- und Tupferzangen	344	Hämmer	42, 235-237
GRUBER, Ohrspekula	3	Ersatzbacken	235-237
GRUENWALD, DUROGRIP Pinzetten, bajonettförmig	441	Hammerkopfstenzen	23
Pinzetten, bajonettförmig	443	Handdermatome	115
GRUENWALD-HENKE, Conchotome	70	Handgriffe	42
GUILFORD-WRIGHT, Drahtscheren	268	Saug-	43
GUTHRIE, Haut- und Wundhäkchen	294	Stabinstrumente	159
GWYNNE-EVANS, Tonsillendisektoren	139	HARDY, TREND E nukleatoren	86, 88
		TREND Küretten	86-88
		HARTMANN, Conchotome	70
		Fasszängchen	18
		Löffelzängchen	21, 22
		Nasenspekula	51, 53, 54
		Nasentamponzangen	93
		Ohrspekula	2-3
<b>H</b>			
HAASE, Repositionszangen	254		
HAJEK, Hämmer	237		

## Alphabetischer Index

## H – J

	Seite		Seite
HARTMANN, Ohrtamponzangen	24	HUGHES, Stapesmobilisatoren	31
Stimmgabeln	7	HUNTER, Splitterpinzetten	455
Tonsillenstanzen	145	HURD, Tonsillendissektoren	138
Tubenkatheter	8	Unterbindungsnadeln	512
Zungenspatel	120	Hypophysenspekula	81, 82
HARTMANN-HALLE, Nasenspekula	51	NOIR	82
HARTMANN-WULLSTEIN, Fasszängchen	18		
Löffelzängchen	21	<b>I</b>	
HARVEY, Blech- und Drahtscheren	268	Implantat-Presszangen	39
Hauthäkchen	294-297	Instrumente, Fremdkörper-	13
Hautkralle	297	für die festsitzende Technik	267
Hautmesszirkel	96, 356	Ligatur-	144
Hautspreizer	285	Mess-	39
Hautstanzen	115	Instrumenten Organisations System	46-47
Hebel, Ohr-	10, 12	Inzisions-Scheren	411
HEERMANN, Flachmeißel	42	Iris, Pinzetten	429
Hämmer	42	Scheren	397, 400
Handgriffe	42		
Hohlmeißel	42	<b>J</b>	
HEGAR-MAYO, DUROGRIP Nadelhalter	503	JACOBSON, Arterienklemmen	471, 476
HEGAR-MAYO-SEELEY, DUROGRIP Nadelhalter	503	Mikro-Federschere	171
HEGAR-OLSEN, DUROGRIP Nadelhalter mit Schere	504	Mikro-Nadelhalter	183
HEGAR-OLSEN MODIF. LANGE, DUROGRIP Nadelhalter mit Schere	504	Scharfe Löffel	216
HEISS, Arterienklemmen	477	JÄGER, Hauthäkchen	296
Präparier- und Ligaturklemmen	488	JAMESON, Feine Präparierscheren	415
HEISTER, Mundsperrer	121	Supercut Scheren	393
HEMINGWAY, Scharfe Löffel	218, 219	JAMESON-WERBER, Feine Präparierscheren	415
HENCKEL-TILLEY, Rongeure	74	JANSEN, Hohlmeißelzangen	245, 246
HENKE, Tonsillendissektoren	138	Pinzetten, bajonettförmig	442
HENKEL, Löffelzängchen	24	Raspatorien	210, 211
HEYMANN, Nasenscheren	90	Scharfe Löffel	216, 218
HEYMANN-KNIGHT, Nasenscheren	90	Wundspreizer	276
Septumzangen	95	JANSEN-MIDDLETON, Nasenzangen	94
HEYWOOD-SMITH, Organ- und Gewebefasszangen	497	JATHO, Nasenrachenzangen	150
Tupfer- und Schwammzangen	497	JEFFERSON, Feine anatomische Pinzetten	429
Zungenzangen	497	Feine chirurgische Pinzetten	446
HEYWOOD-SMITH MODIF., Organ- und Gewebefasszangen	497	Wundspreizer	284
Tupfer- und Schwammzangen	497	JOBSON-HORNE, Ohrsonden	8
Zungenzangen	497	JOHNS-HOPKINS, Anlege- und Abnehmezangen	459
HILL, Raspatorien	101	Bulldogklemmen	459
Hohlmeißel	42, 108, 223, 225-227, 231-233	JOLL (FRIEDMAN), Thyreoid-Spreizer	287
Septum-	105, 107	JOSEPH, Feine Scheren	397, 406
Hohlmeißelzangen	243-247	Haut- und Wundhäkchen	296
ERGOPLANT	244, 248	Hauthäkchen	296
Hohlsonden	516	Irisscheren	397
Führungs-	513, 514	Knochenfeilen	240
Führungs-, PEEK	514	Nasensägen	99
Hornhautpinzetten	429	Plastikmesser	97, 98
HÖSEL, DUROGRIP Nadelhalter	509	Plastikscheren	406
HOUGH, Fasszängchen	18	Raspatorien	209
HOUSE, Saug- und Spülkanülen	540		
Saugadapter	44, 528		
Scharfe Löffel	40, 41, 217		
HOWARD, Raspatorien	101		
HUDSON, Chirurgische Pinzetten	447		
Feine anatomische Pinzetten	429		

## Alphabetischer Index

## J - K

	Seite		Seite
JOSEPH, Supercut Präparierscheren	394	Klemmen, Peripheral-, Atraumatische	467
JUDD-ALLIS, Organ- und Gewebefasszange	494	Peritoneum-	491
JURASZ, Kehlkopfpolypenzange	160	Präparier-	475, 477, 484-490
Nasenrachenzangen	150	Präparier-, Atraumatische	465
		Schlauch-	342, 349, 350, 478
		Sinus-	343
		Tonsillen-	483
		Tuch-	351-354
<b>K</b>		Klingen, Adenotom	149
Kabel, Kaltlicht-	58, 154	Mikrochirurgische-	369
Kaltlichtkabel	58, 154	Skalpell-, Carbon Steel	366, 367
Adapter	58	Skalpell-, Stainless Steel	366, 367
KANTROWITZ, Präparier- und Ligaturklemmen	489	Klingenthaler, ERGOPLANT	368
Kanülen	541	KLINIKUM BERLIN, Schlauchklemmen	349
Saug-	43, 44, 527-541	Kniegebogene Pinzetten	444
Saug-, Fukushima Design	531	Knochen- und Knorpelquetschen	109
Saug-, Mikro	532	Knochenahlen	239
Spül-	80, 540	Knochendeckelelevatoren	200
Kanülenköpfe	544, 545	Knochenfeilen	240
Kartuschenadapter, CO <sub>2</sub> , UNITRAC	60	ERGOPLANT	241
Kathetereinführungszangen	355	Knochenfixierzange	252
KAYE, Supercut Präparierscheren	396	Knochenhaken	322, 323
KAZANJIAN, Knochensplitterzangen	248	Knochenhaltezzangen	252, 253
Kehlkopfnadelhalter	157	Knochenmühle, Mikro, ERGOPLANT	110
Kehlkopfpolypenzangen	160	Reiniger, ERGOPLANT	110
Kehlkopfspiegel	152	Knochenmühlen Kit, Mikro-	111
Kehlkopfzangen	161	Knochenraspeln	240, 241
KELLY, Arterienklemmen	471	DUROGRIP	99, 242
Feine Scheren	406	Knochenscheren	249
KERRISON, Stanzen	255	Knochensplitterzangen	248-250
Stanzen, zerlegbar	262-264	ERGOPLANT	248
Stanzen, nicht zerlegbar	265	Knochenstanzen	255-257
Stanzen, NOIR	258-261	nicht zerlegbar	265
Kette	122	NOIR	258-261
KEYES, Hautstanzen	115	zerlegbar	262-264
Kieferhöhlen-Fasszangen	69	Knopfsonden	518, 519
KILLIAN, Elevatorien	100	Doppel-	518
Knochenschere	249	Sinus-	518
Laryngofissurschere	161	Knorpel- und Knochenquetschen	109
Nasensonde	519	Knorpelritzmesser	97
Nasenspekula	55, 56	Knorpelritzzangen	113
Raspatorien	100	Knorpelscheren	417
Septum-Hohlmeißel	107	Knüpppinzetten, Mikro-	177, 178
KILLIAN-CLAUS, Septum-Hohlmeißel	107	KOCHER, Arterienklemmen	480
KILNER, DUROGRIP Nadelhalter	502	Führungs-Hohlsonden	514
Feine Präparierscheren	412, 415	Knochen- und Wundhaken	322
Hauthäkchen	295	Wund- und Venenhaken	310
Wundhäkchen	297	Wundhaken	322, 331, 337
Wundhaken	312, 318	KOCHER-LANGENBECK, Wundhaken	327
KINGS'S COLLEGE HOSPITAL, Watteträger	521	KOCHER-OCHSNER, Arterienklemmen	481
KIRSCH, Wundhaken	333	KOFLER, Stanzen	257
KIRSTEIN, Nasenscheren	90	KÖNIG, Elevatorien	200, 208
KLAPP, Sehnenscheidenhaken	308	Führungs-Hohlsonden	513
Kleiderscheren	425, 426	Raspatorien	208
KLEINERT-KUTZ, Hauthäkchen	295	Wund- und Venenhaken	310
Klemmen, Arterien-	342, 478-483, 496	Konisationsmesser	366

## Alphabetischer Index

## K – L

	Seite		Seite
Kornzangen	342-347	LATHEBURY-FARRELL, Watteträger	520-522
KRÄMER, Raspatorien	214	LAZAR, Mikro-Knüpppinzetten	177
Wundhaken	335	LELAND-JONES, Atraumatische Klemmen	467
KRAUSE, Nasenpolypenschnürer	114	LEMPERT, Hohlmeißelzangen	246
Ohrpolypenschnürer	13	Raspatorien	38, 208
KRAYENBÜHL, Nerv- und Gefäßhäkchen	292	Saugkanülen	534
KRONECKER, Unterbindungsnadeln	510	Scharfe Löffel	221
KRÖNLEIN, Arterienklemmen	342	LERICHE, Arterienklemmen	473
Küretten, Antrum-	78	LEWIS, Knochenraspeln	240
Ohr-	11	LEXER, DUROTIP Präparierscheren	383, 386
TREND-	86-88	Hohlmeißel	233
TREND-, abwinkelbar	86	NOIR Feine Präparierscheren	379
		Osteotome	233
<b>L</b>		Präparierscheren	420
LA FORCE, Adenotome	149	LEXER-MINI, Hohlmeißel	232
Adenotomklingen	149	Osteotome	232
LA GRANGE, Feine Scheren	405	LICHTENBERG, DUROGRIP Nadelhalter	509
LABORDE, Trachealdilatatoren	274	Lichtleiter	58, 154
LACK, Zungenspatel	119	Lichtleiteradapter	58
Lagerungsracks	45	Ligaturinstrumente	144
LAHEY, Organ- und Gewebefasszangen	135	Ligaturklemmen	475, 477, 484-490
Präparier- und Ligaturklemmen	490	Atraumatische-	465
Wundhaken	332	Ligaturscheren	424
LAHEY (SWEET), Präparier- und Ligaturklemmen	490	DUROTIP	390
LAMBOTTE, Osteotome	228, 230	LISTER, Sinusklemmen	343
Lampen, Ersatz-	6	Verband- und Kleiderscheren	425, 426
LANDOLT, Eukleationsscheren	413	LISTON, Knochensplitterzangen	249
Präpariersauger	104, 539	LITTLER, Feine Präparierscheren	412
Raspatorien	211	LOCKLIN, Feine Scheren	405
Skalpellgriff	369	LOCKWOOD, Organ- und Gewebefasszangen	496
Spreizzangen	81	Löffel, Antrum-	77
Tumorfasszangen	85	Scharfe-	40, 41, 216-222
LANDOLT-REULEN, TREND Dissektoren	87, 88	Scharfe-, ERGOPLANT	218
TREND Häkchen	87, 88	Stirnhöhlen-	77
LANE, Chirurgische Pinzetten	453	Zerumen-	8, 10
LANGE, Fistelhaken	307	Löffelzängchen	21, 22, 24
Raspatorium	207	Mikro-Larynx-	156, 157
LANGENBECK, DUROGRIP Nadelhalter	508	LOPEZ-REINKE, Tonsillendisektoren	539
Elevatoren	201	LORNA, Tuchklemmen	353
Knochenhalte-zangen	252	LOWER, Präparier- und Ligaturklemmen	490
Raspatorien	213, 214	LUBET, Nasentamponzangen	92
Rippenraspatorien	214	LUC, Septumzangen	71
Wundhaken	326	LUCAE, Ohrhebel	12
LANGENBECK-GREEN, Wundhaken	305	Paracentesenadeln	9
LANGENBECK-MANNERFELT MODIF., Wundhaken mit		Pinzetten, bajonettförmig	442
Triangle-Griff	303	Stimmgabeln	7
Lappenmesser, Mikro-	32	LUCAS, ERGOPLANT Scharfe Löffel	218
Laryngofissurscheren	161	Flachmeißel	227
Laryngoskope, Operations-	153	Hohlmeißel	227
Laryngoskophalter	153	Scharfe Löffel	219
Larynx-Fasszängchen, Mikro-	155	LUER, Hohlmeißelzangen	244, 245
Larynx-Löffelzängchen, Mikro-	156, 157	Wundhaken	314
Larynx-Scherchen, Mikro-	156	LUER-FRIEDMANN, ERGOPLANT Hohlmeißelzangen	244
		Hohlmeißelzangen	243
		Lupusspatel	98

	Seite		Seite
<b>M</b>			
MAC DONALD, Raspatorien	100	Messer, Faden-, Stainless Steel	367
MAGAURAN, Mundsperrerhalter	134	Furunkel-	9
MAGILL, Kathetereinführungszangen	355	Knorpelritz-	97
Saugkanülen	536	Konisation-	366
MAIER, Korn- und Tupferzangen	346	Lappen, Mikro	32
MALTZ, Knochenraspeln	240	Mikro-	31-35, 158
MANNERFELT MODIF., Flachmeißel	223	Mukosa-	96
Gabelhaken mit Treangle-Griff	300	Plastik-	97, 98
Osteotome	223	Ring-	146-148
Raspatorien	207	Rund-, Mikro	33-35
Sattelhaken mit Treangle-Griff	304	Schäl-	158
Wundhaken mit Treangle-Griff	300, 301, 303	Schwing-	96
MARBURG MODELL, Flachzangen	267	Septum-	98
MARQUARDT, Hohlmeißelzangen	247	Sichel-	9, 77, 158
MARTINI, Scharfe Löffel	216	Teller-	369
MASING, DUROGRIP Nadelhalter	501	Tonsillen-	140
Elevatorien	99, 203	TREND, abwinkelbar	86
Knorpelritzmesser	97	Messinstrumente	39
Osteotome	105	Messschieber	356
Wund- und Venenhaken	309	METZENBAUM, DUROTIP Präparierscheren	385, 388, 389
Maßbänder	356	Feine Präparierscheren	398
MATHIEU, DUROGRIP Nadelhalter	509	NOIR Feine Präparierscheren	377, 378
Wundhaken	320	NOIR Präparierscheren	376-378
MAYFIELD, Hohlmeißelzangen	247	Präparierscheren	422
MAYO, Chirurgische Scheren	418	Supercut Präparierscheren	395
DUROTIP Präparierscheren	382, 386	MEYERDING, Wundhaken	306
NOIR Präparierscheren	378	MICRO-ADSON, Feine anatomische Pinzetten	429
Präparierscheren	418, 419, 421	Feine chirurgische Pinzetten	445, 446
Supercut Präparierscheren	394	Präparier- und Ligaturklemmen	484
MAYO-LEXER, DUROTIP Präparierscheren	383, 387	Feine anatomische TITANIUM Pinzetten	428
NOIR Präparierscheren	379	Feine chirurgische TITANIUM Pinzetten	428
Präparierscheren	420	MICRO-ADSON-BIEMER, Feine chirurgische Pinzetten	445
MAYO-STILLE, Chirurgische Scheren	418	MICRO-HALSTED, Arterienklemmen	470
Präparierscheren	418, 419	MIDDELDORPF, Wundhaken	334
MC CLURE, Mikro-Federscheren	168	Mikro, Approximatoren	194
MC INDOE, Feine anatomische Pinzetten	431	Crutomiescheren	15
Feine chirurgische Pinzetten	449	Dissektoren	37
Hauthäkchen	295	Fadengabel	158
Hohlmeißel	108	Fadenscheren	173
Knochensplitterzangen	250	Federscheren	168-175
MC IVOR, Bügel für Zungenspatel	125	Fußplattenhäkchen	29
Zungenspatel	130	Gefäßdilatoren	179
MC KENTY, Raspatorien	208	Häkchen	27, 28, 30, 158
MC KISSOCK, Raspatorien	214	Knochenmühle, ERGOPLANT	110
MEAD, Hämmer	235	Knochenmühlen, Kit	111
Hohlmeißelzangen	246	Knüpppinzetten	177, 178
MEHDORN, Anlegepinzetten für Gefäßclips	193	Lappenmesser	32
Gefäßclips	192	Larynx-Fasszängchen	155
Meißel	233	Larynx-Löffelzängchen	156, 157
Flach-	42, 108, 223, 225-227, 230, 232	Larynx-Scherchen	156
Hohl-	42, 105, 107, 108, 223, 225-227, 231-233	Larynx-Zängchen	157
Septum-	105, 107	Messer	31, 158
Messer, Diamant-	371	Nadelhalter	181-184
Faden-, Carbon Steel	367	Nadelhalter, Dia Dust	185-189, 507
		Nadelhalter, Dia Dust, TITANIUM	166, 167
		Nadelhalter, DUROGRIP	190, 191





## Alphabetischer Index

## P – R

	Seite		Seite
Pinzetten, für Weichgewebe, ERGOPLANT	428	<b>Q</b>	
Gefäß-	454	QUERVAIN, Elevatorien	201
Hornhaut-	429	QUIRE, Fremdkörperinstrumente	13
Iris-	429		
kniegebogen	444	<b>R</b>	
Knüpf-	177, 178	RAABE, Mikro-Saugkanülen	532
Mikro-	177, 178, 180	Racks, Lagerungs-	45
Mikro-, Atraumatische	180	RAGNELL, Feine Präparierscheren	399
Mikro-, Dia Dust	180	Wundhaken	315
Mikro-, Uhrmacher-Modelle	176	RAMPLEY, Tupfer- und Schwammzangen	348
Naht-, DUROGRIP	441	RAMSEY, Anatomische Pinzetten	435
Ring-	180	RANKIN, Arterienklemmen	474
Splitter-	455	Raspatorien	38, 99-101, 202, 205, 207-215
Tumor-	454	Mikro-	36-38
Ultra-Light-, Atraumatische	436	Rippen-	214, 215
Plastikmesser	97, 98	Saug-	104
Plastikscheren	406	Raspeln, Diamant-	240
Platte, Gaumen-	125	Knochen-	240, 241
PLESTER, Antrumhäkchen	30	Knochen-, DUROGRIP	99, 242
Mikro-Fußplattenhäkchen	29	REDON, Führungsnadeln	523
Mikro-Lappenmesser	32	REILL, Drahtschneidezangen	271
Mikro-Schaber	30	Mikro-Nadelhalter	182
Raspatorium	210	Repositionszangen	254
Saugkanülen	43, 530	Reiniger für Knochenmühle, ERGOPLANT	110
Saugkanülenset	43, 526	Repositionszangen	254
Wundspreizer	280, 281	Retraktoren, Nasen-	103
PLESTER-HELMS, Wundspreizer	280	Nasenflügel-	102
Plexiglasstäbchen	234	Tonsillen-	138
POLITZER, Furunkelmesser	9	Zungen-, ERGOPLANT	120
Ohrspekula	2	REYNOLDS, Feine Präparierscheren	416
Paracentesenadeln	9	REYNOLDS-JAMESON, Gefäßscheren	399
Sichelmesser	9	Ringmesser	146-148
Polypenschnürer, Nasen-	114	Rippenfasszangen	253
Ohr-	13	Rippenraspatorien	214, 215
Polypenzangen, Kehlkopf-	160	Rippenscheren	251
POTTS, Feine Präparierscheren	416	RITTER, Stirnhöhlendilator	80
POTTS-SMITH, Gefäßscheren	423	RNTNE-HOSPITAL, Wundspreizer	282
Präparierklemmen	475, 477, 484-490	ROBIN, Tuchklemmen	352
Atraumatische-	465	ROCHESTER-CARMALT, Arterienklemmen	482
Präpariersauger	104, 539	ROCHESTER-OCHSNER, Arterienklemmen	480
Präparierscheren	412, 418-422	ROCHESTER-PEAN, Arterienklemmen	479
DUROTIP	382-389	ROEDER, Ligaturinstrumente	144
Feine-	398, 399, 406, 412-417	Tuchklemmen	351
Feine-, NOIR	375-379	Röhrchen, Spül-	79
Mikro-	171	Rohrschaftzängchen	155
Nerv-	399, 406, 415	ROLLET, Hauthäkchen	294
NOIR-	376-379	Rongeurs	72-76, 85
Supercut-	394-396	ROSE, Wundhaken	314
Präpariertabletts	39	ROSEN, Mikro-Lappenmesser	32
Presszangen, Implantat-	39	Mikro-Nadeln	25
PRICHARD, Raspatorium	207	Ohrspekula	4, 5
PROVIDENCE-HOSPITAL, Arterienklemmen	471	ROSER-KÖNIG, Mundsperrer	123



## Alphabetischer Index

## R – S

	Seite		Seite
ROUX, Wundhaken	317, 319	Scheren, Faden-	173
ROWBOTHAM, Saugkanülen	536	Faden-, DUROTIP	380, 386
Rundfeilen	234	Faden-, Feine	375
Rundmesser	33-35	Faden-, NOIR	375
RUSKIN, Hohlmeißelzangen	247	Feder-	168-175
RUSKIN-LISTON, Knochensplitterzangen	250	Feine-	397-406, 412
RUSS. MODELL, Chirurgische Pinzetten	454	Feine-, DUROTIP	380
RUSSEL-DAVIS, Zungenspatel	127, 128	Gefäß-	399, 414, 423
RYDEL-SEIFFER, Stimmgabeln	7	Inzisions-	411
RYDER, Dia Dust Mikro-Nadelhalter	507	Iris-	397, 400
DUROGRIP Nadelhalter	506	Kleider-	425, 426
TITANIUM Nadelhalter	507	Knochen-	249
		Knorpel-	417
<b>S</b>		Laryngofissur-	161
Sägen, Nasen-	99	Ligatur-	424
SAROT, DUROGRIP Nadelhalter	503	Ligatur-, DUROTIP	380, 386, 390
Sattelhaken, Treangle-Griff	304	Mikro-	14, 15, 65, 83, 84, 156, 168-175
SAUERBRUCH, Rippenscheren	251	Nagelhaut-	400
Wundhaken	332	Nasen-	65, 90, 91
Saugadapter	44, 528	Nasenflügel-	413
Saugdissektoren	104	Nasenplastik-	413
Sauger, Präparier-	104, 539	NOIR-	375-379
Saughandgriffe	43	NOIR-, mit Wellenschliff	375-379
MINOP TREND	63	Plastik-	406
Saugkanülen	43, 44, 527-540	Präparier-	171, 412, 418-422
Fukushima Design	531	Präparier-, DUROTIP	382-389
Mikro-	532	Präparier-, Feine	375-399, 406, 412-417
Saugkanülenset	43, 526	Präparier-, Nerv	406
Saugraspatorium	104	Präparier-, NOIR	375-379
Saugrohr, Nasen-	535	Präparier-, Supercut	394-396
Saugrohre	526	Rippen-	251
Saugschäfte, MINOP TREND-	64	Schwestern-	425
Saugschläuche, MINOP TREND-	63	Sehnen-	414
Schaber, Mikro-	30	Septum-	91
Schäfte, Spül-/ Saug-, MINOP TREND	64	Speichelgang-	404
Schälmesser	158	Strabismus-	398
Scharfe Löffel	40, 41, 216-222	Supercut-	392, 393
ERGOPLANT-	218	Supercut-, Feine-	392
SCHEDE, Scharfe Löffel	220	Tonsillen-	141
Scherchen, Mikro-Larynx-	156	Venen-	170
Scheren, Arteriotomie-	416	Verband-	425, 426
Augen-	169	Wundrand-	408
Blech-	268, 269	Schieber, Mess-	356
Blech-, DUROTIP	268	Schilddrüsenhaken	311
Bulldog-	412	SCHINK, Handdermatom	115
Chirurgische-	407-411, 418	Schläuche, Silikon-, Ersatz	121
Chirurgische-, DUROTIP	381, 386	Spül-/ Saug-, MINOP TREND	63
Crurotomie-	15	Schlauchklemmen	342, 349, 350, 478
Draht-	268, 269	Schleifsteine	234
Draht-, DUROTIP	268	Schlingen, Draht-	13, 114, 143
DUROTIP-	268, 380-385	Ohr-	10
DUROTIP-, mit Wellenschliff	386-390	SCHMIEDEN, Führungs-Hohlsonden	513
Enukleations-	413	Schneideplatten, ERGOPLANT	110
		Schneidezangen, Draht-	270
		Schnellkupplung, UNITRAC	61
		SCHNIDT, Arterienklemmen	483

## Alphabetischer Index

## S

	Seite		Seite
<b>SCHNIDT</b> , Tonsillenklemmen	483	Skalpelle, Einmal-	358-362
Schnürdrähte	143	Mikro-	362
Schnürer, Ohrpolypen-	13	Sicherheits-	358, 359
Tonsillen-	142, 144	Steril-	360-362
Tonsillen-, SUSI	142	Skapellgriffe	363-365
<b>SCHOENBORN</b> , Wund- und Venenhaken	311	Mikrochirurgische Klengen	368, 369
<b>SCHUHKNECHT</b> , Mikro-Rundmesser	35	Skapellklengen, Carbon Steel	366, 367
Saugkanülen	535	Mikrochirurgische-	369
Schwammzangen	348, 497	Stainless Steel	366, 367
<b>SCHWARTZ</b> , Clip-Anlegezangen	198	<b>SLUDDER-BALLENGER</b> , Tonsillotome	145
Gefäßclips	198	Tonsillotomgriff	145
<b>SCHWECKENDICK</b> , Tonsillenscheren	141	<b>SNELLEN</b> , Ohrschlinge	10
<b>SCHWEDISCHES MODELL</b> , Anatomische Pinzetten	435	Sonden, Augen-	519
Schwestenscheren	425	Doppelknopf-	518
Schwingmesser	96	Hohl-	513, 514, 516
<b>SEBILEAU</b> , Elevatorien	201	Hohl-, PEEK	514
<b>SEDILLOT</b> , Raspatorien	213	Knopf-	518, 519
Sehndurchziehsonden	517	Knopf-, Sinus	519
Sehnenscheidenhaken	308, 309	Myrtenblatt-	517
Sehnenscheren	414	Nasen-	519
<b>SEIFFERT</b> , Speichelgangsonden	519	Ohr-	8, 519
Seitenschneider	271	Öhr-	517
<b>SELDIN</b> , Raspatorien	205	Sehndurchzieh-	517
<b>SELMAN</b> , Chirurgische Pinzetten	454	Speichelgang-	519
<b>SEMB</b> , Knochenhalte-zangen	253	Stirnhöhlen Ostium	80
Rippenfasszangen	253	Spannarm	6
<b>SEMKEN</b> , Feine anatomische Pinzetten	431	Spannplatte, Dermatome	115
Feine chirurgische Pinzetten	448	Spatel, Lupus-	98
<b>SENN-MILLER</b> , Wundhaken	312	Zungen-	118-120, 127-133, 520
Septumhohlmeißel	105, 107	Speichelgang-scheren	404
Septummesser	98	Speichelgang-sonden	519
Septumrichtzangen	112	Spekula, Hypophysen-	81, 82
Septumscheren	91	Hypophysen-, NOIR	82
Septumspekula	57	Nasen-	50-59
Septumzangen	71, 95	Ohr-	2-5
Set, Saugkanülen-	43, 526	Septum-	57
<b>SEWALL</b> , Elevatorien	202	<b>SPENCER</b> , Ligaturscheren	424
Raspatorien	202	<b>SPENCER-WELLS</b> , Arterienklemmen	478
<b>SHAMBAUGH</b> , Mikro-Häkchen	27, 28	Sperrer, Carotis-	279
<b>SHEA</b> , Ohrspekula	5	Mund-	121, 123, 124
Scharfe Löffel	40	Spiegel, Kehlkopf-	152
Sichelmesser	9, 77	Nasen-	96
Mikro-	158	Spiegelgriffe	152
Sicherheitsskalpelle, Einmal-	358, 359	Splitterpinzetten	455
Siebbeinzangen	72, 74-76	Splitterzangen	455
Siebtray, MINOP TREND-	63	Spray, Öl-, STERILIT	551-553
Silikoneinlage	125	Spreizer, Glomus	286
Silikonmundkeile, ERGOPLANT-	122	Haut-	285
Silikonschläuche, Ersatz-	121	Struma-	287
<b>SILVER</b> , Handdermatom	115	Thyroid-	287
<b>SIMON</b> , Fistelhaken	307	Wund-	275-285, 289
<b>SIMS-MAIER</b> , Korn- und Tupferzangen	347	Spreizinstrument	82
Sinusklemmen	343	Spreizzangen	81
Sinus-Knopfsonden	518	Spritzen	541-543
Sinuskopie-Trokar	80	Spülgriffe, MINOP TREND-	63
Skalpelle, Mikro-	362	Spülkanülen	80, 540

	Seite		Seite
Spülröhrchen	79	SUSI Tonsillenschnürer	142
Spülschäfte, MINOP TREND-	64	SYME, Raspatorien	205
Spülschläuche, MINOP TREND-	63	Tonsillendisektoren	139
ST. BARTS, Ohrhäkchen	12, 288	Syndesmotome	202
Rongeurs	74, 75		
ST. CLAIR-THOMPSON, Nasenspekula	50	<b>T</b>	
Ringmesser	148	Tablets, Präparier-	39
ST. MARTIN, Augenpinzetten	445	TAKAHASHI, Rongeurs	75, 76
Feine chirurgische Pinzetten	445	Tamponzangen, Nasen-	92, 93
Stäbchen, Test	234	Ohr-	24
Stabinstrumente, Handgriff für-	159	Tellermesser	369
STACKE, Ohrsonde	519	TESSIER, Osteotome	226
STAMM, Knochensplitterzangen	248	Teststäbchen	234
STAMMBERGER, Antrumstanzen	67	THOREK, Gefäßscheren	423
STANDARD, DUROGRIP Pinzetten	441	THORPE, Feine anatomische Pinzette	429
Stanzen, Antrum-	66, 67	Hornhautpinzette	429
Hammerkopf-	23	Thyroid-Spreizer	287
Haut-	115	TIECK-HALLE, Nasenspekula	52, 57
Knochen-	255-257	TILLEY, Nasentamponzangen	92
Knochen-, nicht zerlegbar	265	Ohrtamponzangen	24
Knochen-, NOIR	258-261	TILLEY-LICHTWITZ, Antrumtrokare	79
Knochen-, zerlegbar	262-264	Tissue, forceps	453
Nasennebenhöhlen-	66	TITANIUM, Anatomische Pinzetten, Feine	428, 431
Tonsillen-	145	Atraumatische Pinzetten	437
Stapeslevatorien	36	Atraumatische Gefäßklemmen	468, 469
Stapesmobilisatoren	31	Chirurgische Pinzetten, Feine	428, 431
STELLBRINK, Hohlmeißelzangen	243	Dia Dust, Mikro-Nadelhalter	166, 167
Steriler Überzug für den UNITRAC Haltearm	61	Feine anatomische Pinzetten	428
STERILIT, Öl	234, 552, 553	Feine chirurgische Pinzetten	428
Ölspray	551-553	Nadelhalter	507
Sterilskalpelle	360-362	TOBOLD, Zungenspatel	120
STERNBERG, Wundhaken	313	TÖNNIS, Durahäkchen	294
STEVENS, Feine Präparierscheren	398, 414	DUROGRIP Nadelhalter	508
Gefäß- und Sehnenscheren	414	Feine Präparierscheren	417
Supercut Scheren	392	TÖNNIS MODIF., DUROGRIP Nadelhalter	508
STIEGLITZ, Splitterzangen	455	TÖNNIS-ADSON, DUROTIP Präparierscheren	384, 387
STILLE, Flachmeißel	230	Feine Präparierscheren	416
Hohlmeißel	231	NOIR Feine Präparierscheren	377
Osteotome	231	Tonsillendisektoren	138, 139, 539
Präparierscheren	420	Tonsillenfasszangen	136, 137, 1140
STILLE-BARAYA, Gefäß- und Tumorphinzetten	454	Tonsillenklemmen	483
Stimmgabeln	7	Tonsillennmesser	140
Stirnhöhlen Ostium Sonden	80	Tonsillennretraktoren	138
Stirnhöhledilatoren	80	Tonsillenscheren	141
Stirnhöhledoppelinstrument	80	Tonsillenschnürer	142, 144
Stirnhöhlenlöffel	77	SUSI	142
Stößel	238	Tonsillenstanzen	145
Strabismusscheren	398	Tonsillotome	145
STRANDELL-STILLE, Sehnenscheidenhaken	309	Tonsillotomgriff	145
STRASSBURGER MODELL, Chirurgische Pinzetten	454	TOYNBEE, Ohrspekula	3
Strumaspreizer	287	Trachealdilatoren	274
STRUYCKEN, Conchotome	70	Trachealhäkchen	298-299
Stütze, Brust-	134, 153	Träger, Watte-	520-522
Supercut, Scheren	392, 393		
Feine Scheren	392		
Präparierscheren	394-396		

## Alphabetischer Index

## T – Y

	Seite		Seite
Tränenkanal-Dilatator	519	<b>VOLKMANN</b> , Knochen- und Wundhaken	322, 323
Transplantatträger	36	Scharfe Löffel	221
Trays, Sieb-, MINOP TREND	63	Wundhaken	324
TRELAT, Raspatorien	209		
TREND, Dissektoren	87, 88	<b>U</b>	
Dissektoren, abwinkelbar	86	<b>WAGENER</b> , Ohrhäkchen	12
Eukleatoren	86, 88	Nerv- und Gefäßhäkchen	290
Häkchen	87, 88	<b>WALSHAM</b> , Septumrichtzangen	112
Küretten	86–88	<b>WALTER</b> , Flachmeißel	108
Küretten, abwinkelbar	86	Hohlmeißel	231
Messer, abwinkelbar	86	Osteotome	107
Trephine, Antrum-	79	Wundhaken	103
TROELTSCH, Pinzetten, kniegebogen	444	<b>WANGENSTEEN</b> , DUROGRIP Pinzetten	441
Trokare, Antrum-	79	<b>WARD</b> , Raspatorien	209
Sinuskopie-	80	Waschzangen	345
Universal-	80	<b>WATSON-CHEYNE</b> , Raspatorien	100, 206
TROUSSEAU, Trachealdilatatoren	274	<b>WATSON-WILLIAMS</b> , Rongeurs	76
Tuchklemmen	351–354	Watteträger	520–522
TUDICHUM, Nasenspekula	50	<b>WAUGH</b> , Feine chirurgische Pinzetten	449
TUFFIER, Organ- und Gewebefasszangen	492	<b>WEBER</b> , Ohrschlingen	10
TUMARKIN, Ohrspekula	4	<b>WEBSTER</b> , DUROGRIP Nadelhalter	501
Tumorfasszangen	85	<b>WEDER</b> , Zungenspatel	119
Tumorphinzetten	454	<b>WEIL-BLAKESLEY</b> , Rongeurs	72
Tupferzangen	342–348, 497	<b>WEITLANER</b> , Wundspreizer	277–279
TYDING, Tonsillenschnürer	144	<b>WEST</b> , Nasentamponzangen	92
		<b>WHITE</b> , Tonsillenfasszangen	136
<b>U</b>		<b>WHITEHEAD</b> , Mundsperrer	124
<b>UFFENORDE</b> , Scharfe Löffel	220	<b>WHITEHEAD-JENNINGS</b> , Mundsperrer	124
<b>ULRICH-AESCLAP</b> , Korn- und Tupferzangen	345	<b>WIENER MODELL</b> , Nasenspekula	53, 54
Waschzangen	345	<b>WIKSTROEM</b> , Präparier- und Ligaturklemmen	488
Ultra-Light-Pinzetten, ATRAUMATA	436	<b>WILDE</b> , Nasenpolypenschnürer	114
UNITRAC, CO <sub>2</sub> Druckkartusche	60	Pinzetten, kniegebogen	444
CO <sub>2</sub> Kartuschenadapter	60	<b>WILDER</b> , Tränenkanal-Dilatator	519
Haltearm	60	<b>WILLIGER</b> , Elevatorien	200
Haltearm, steriler Überzug	61	Raspatorien	209
Schnellkupplung	61	Scharfe Löffel	216, 221
Universaltrokare	80	<b>WILSON</b> , Arterienklemmen	483
Unterbindungsnadeln	158, 510–512	Tonsillenklemmen	483
US-ARMY, Wundhaken	321	<b>WULLSTEIN</b> , Mikro-Nadel	25
		Raspatorien	38
<b>V</b>		Wundspreizer	278
<b>VANNAS</b> , Mikro-Federschere	168, 170, 171	Wundhäkchen	294–299
Venenhäkchen	291	Wundhaken	103, 296, 300–337
Venenhaken	309–311	Trengle-Griff	300, 301, 303, 304
Venenschere, Mikro-	170	Wundrandschere	408
Verbandschere	425, 426	Wundspreizer	275–285, 289
Verbindungsklemme, flexibel	60		
VERHOEVEN, Saugkanülen	44, 527	<b>Y</b>	
VIDAL, Lupusspatel	98	<b>YANKAUER</b> , Saugkanülen	537
WISE, Mikro-Knüpfpinzetten	177	<b>YASARGIL</b> , Mikro-Zange	83

## Alphabetischer Index

Y - Z

	Seite		Seite
YASARGIL, Rongeur	85	Zangen, Organfass-, Atraumatische	495
Spannarm	6	orthodontische	267
Tellermesser	369	Repositions-	254
		Rippenfass-	253
		Schwamm-	348, 497
		Septum-	71, 95
		Septumricht-	112
		Siebbein-	72, 74-76
		Splitter-	455
		Spreiz-	81
		Tonsillenfass-	136, 137, 140
		Tumorfass-	85
		Tupfer-	342-348, 497
		Wasch-	345
		Zungen-	497
		ZAUFAL, Ohrhebel	10
		ZAUFAL-JANSEN, Hohlmeißelzangen	247
		ZENKER, Wundhaken	337
		Zerumenlöffel	8, 10
		Zirkel, Hautmess-	96, 356
		ZOELLNER, Saugkanülen	43, 44, 527, 528
		Zugendrücker	118
		Zungenretraktoren, ERGOPLANT	120
		Zungenspatel	118-120, 127-133, 520
		Zungenspatel, Bügel für-	125, 126
		Zungenzangen	497
Zahnschutz	154		
Zängchen, Fass-	16-20, 69, 84		
Fass-, Mikro-Larynx-	155		
Löffel-	21, 22, 24		
Löffel, Mikro-Larynx-	156, 157		
Mikro-Larynx-Fass-	155		
Mikro-Larynx-Löffel-	156-157		
Rohrschaft-	155		
Zangen, Abnehme-, Bulldogklemmen	459		
Anlege-, Bulldogklemmen	459		
Arterienfass-	135		
Atraumatische Gewebefass-	495		
Atraumatische Organfass-	495		
Clipanlege-	198		
Drahtbiege-	23, 267		
Drahtfass-, DUROGRIP	266		
Drahtschneide-	270, 271		
Drahtschneide-, DUROTIP	270		
Drahtspann-, DUROGRIP	266		
DUROTIP, Drahtschneide-	270		
Fass-	68, 69, 135, 492-497		
Feine Nasen-	73		
Flach-	267		
Gewebefass-	135, 492-497		
Gewebefass-, Atraumatische	495		
Giraffen-	68		
Hakenfass-	135		
Hohlmeißel-	243-247		
Hohlmeißel-, ERGOPLANT	244		
Implantat-Press-	39		
Kathetereinführungs-	355		
Kehlkopf-	161		
Kehlkopfpolyphen-	160		
Kieferhöhlenfass-	69		
Knochenfixier-	252		
Knochenhalte-	252, 253		
Knochensplitter-	248-250		
Knochensplitter-, ERGOPLANT	248		
Knorpelfass-	153		
Knorpelritz-	113		
Korn-	342-347, 497		
Mikro-	83		
Nasen-	73, 94		
Nasen-, Feine	73		
Nasenrachen-	150		
Nasentampon-	92, 93		
Ohrtampon-	24		
Organfass-	135, 492-497		

# Alphabetischer Index

Index  
Index

- Numerical Index
- Nummernverzeichnis

## Numerical Index – Nummerischer Index

## 55 – BC

Cat. No. Art. Nr.	Page Seite	Cat. No. Art. Nr.	Page Seite	Cat. No. Art. Nr.	Page Seite	Cat. No. Art. Nr.	Page Seite
5518016	361	AN909R	349	BB071R	364	BC023R	398
5518032	360	AN910R	349	BB073R	363	BC026R	399
5518040	360	AN911R	350	BB074R	363	BC027R	399
5518059	360	AN912R	350	BB075R	363	BC029R	399
5518067	361	AN913R	350	BB077R	364	BC030R	404
5518075	361			BB078R	364	BC033R	404
5518083	361	BA210	360	BB079R	364	BC034R	404
5518091	361	BA211	360	BB080R	365	BC050R	403
5518105	360	BA212	360	BB084R	365	BC056R	400
		BA215	360	BB085R	365	BC057R	400
16600487	367	BA215-1	360	BB088R	365	BC058R	412
16600495	366	BA215-C	360	BB089R	365	BC060R	400
16600509	366	BA218	360	BB331R	369	BC061R	400
16600517	366	BA219	361	BB332R	369	BC064R	400
16600525	366	BA220	361	BB361R	369	BC065R	400
16600541	367	BA221	361	BB362R	369	BC100R	400
16600550	367	BA222	361	BB363R	369	BC101R	400
16600568	367	BA223	361	BB364R	369	BC106R	401
16600576	367	BA224	361	BB365R	369	BC107R	401
16600584	367	BA311SU	362	BB367R	369	BC110R	401
16600592	367	BA323SU	362	BB368R	369	BC111R	401
16615492	366	BA364	362	BB369R	369	BC112R	401
16615522	367	BA365	362	BB500	367	BC113R	401
16616634	367	BA367	362	BB510	366	BC117R	401
		BA706R	115	BB511	366	BC130R	402
AA804R	356	BA708R	115	BB512	366	BC131R	402
AA805R	356	BA709R	115	BB513	366	BC135R	402
AA806R	356	BA715R	115	BB515	366	BC140R	402
AA845R	356	BA716SU	115	BB515-1	366	BC141R	402
AA846R	356	BA810SU	358	BB515-C	366	BC144R	402
AA847R	356	BA811SU	358	BB518	367	BC145R	402
		BA812SU	358	BB519	367	BC153R	403
AC468R	152	BA813SU	358	BB520	367	BC154R	405
AC469R	152	BA815-1SU	358	BB521	367	BC156R	406
AC470R	152	BA815-CSU	358	BB522	367	BC157R	406
AC471R	152	BA815SU	358	BB523	367	BC160R	406
AC472R	152	BA818SU	358	BB524	367	BC161R	406
AC473R	152	BA819SU	359	BB525	367	BC162R	412
AC474R	152	BA820SU	359	BB536	367	BC163R	412
AC475R	152	BA821SU	359	BB540	366	BC164R	412
AC476R	152	BA822SU	359	BB542	366	BC165R	412
AC477R	152	BA823SU	359			BC166R	415
AC478R	152	BA824SU	359	BC004R	397	BC168R	415
AC479R	152	BA825SU	359	BC005R	397	BC170R	414
AC480R	152	BA836SU	359	BC006R	397	BC171R	414
AC481R	152			BC007R	397	BC172R	414
AC483C	152	BB045T	368	BC008R	398	BC173R	414
		BB046R	368	BC009R	398	BC175R	415
AN379R	355	BB048R	368	BC010R	398	BC177R	415
AN380R	355	BB052R	368	BC011R	398	BC178R	416
AN381R	355	BB053R	369	BC015R	399	BC180R	416
AN709R	497	BB054R	368	BC017R	399	BC181R	416
AN710R	497	BB063R	364	BC020R	398	BC184R	417
AN711R	497	BB068R	363	BC021R	398	BC186R	414
AN908R	349	BB070R	364	BC022R	398	BC187R	414



## Numerical Index – Nummerischer Index

BC

Cat. No. Art. Nr.	Page Seite	Cat. No. Art. Nr.	Page Seite	Cat. No. Art. Nr.	Page Seite	Cat. No. Art. Nr.	Page Seite
BC188R	417	BC271WB	377	BC423R	407	BC607R	422
BC189R	417	BC273B	377	BC424R	407	BC628R	415
BC194R	414	BC273R	384	BC425R	407	BC629R	416
BC195R	414	BC273W	387	BC426R	407	BC630R	416
BC196R	406	BC273WB	377	BC427R	407	BC631R	416
BC210B	375	BC274R	385	BC428R	407	BC633R	417
BC210R	380	BC275B	378	BC441R	410	BC634R	417
BC211B	375	BC275R	385	BC443R	410	BC635R	417
BC211R	380	BC275W	388	BC444R	410	BC636R	423
BC211W	386	BC275WB	378	BC445R	410	BC643R	423
BC211WB	375	BC276R	385	BC464R	411	BC658R	423
BC224R	381	BC277R	385	BC474R	411	BC659R	423
BC228R	381	BC277W	388	BC496R	408	BC672R	417
BC231R	381	BC283B	379	BC497R	408	BC680R	422
BC231W	386	BC283R	383	BC503R	411	BC683R	422
BC234R	381	BC283W	386	BC504R	411	BC801R	424
BC242R	382	BC283WB	379	BC506R	411	BC802R	424
BC243R	382	BC284B	379	BC544R	418	BC803R	424
BC250R	382	BC284R	383	BC545R	418	BC805R	424
BC251R	382	BC284W	387	BC547R	418	BC814R	268
BC252B	378	BC284WB	379	BC554R	418	BC815R	268
BC252R	382	BC287W	389	BC555R	418	BC848R	426
BC253B	378	BC294W	390	BC557R	418	BC849R	426
BC253R	382	BC295W	390	BC558R	382	BC860R	426
BC253W	386	BC303R	408	BC559R	382	BC861R	426
BC253WB	378	BC304R	408	BC562R	419	BC862R	426
BC256R	384	BC313R	409	BC563R	419	BC863R	426
BC257B	375	BC314R	409	BC564R	419	BC876R	426
BC257R	384	BC315R	409	BC565R	419	BC881R	425
BC257W	387	BC316R	409	BC570R	418	BC885R	425
BC257WB	375	BC317R	409	BC572R	418	BC890R	425
BC258R	384	BC320R	407	BC573R	418	BC900R	392
BC259B	376	BC321R	407	BC575R	418	BC901R	392
BC259R	384	BC323R	407	BC576R	419	BC903R	392
BC259W	387	BC324R	407	BC577R	419	BC904R	392
BC259WB	376	BC325R	407	BC578R	419	BC905R	392
BC260R	385	BC326R	407	BC579R	419	BC906R	392
BC261B	376	BC327R	407	BC580R	420	BC907R	392
BC261R	385	BC328R	407	BC581R	420	BC909R	393
BC261W	388	BC330R	407	BC584R	421	BC911R	393
BC261WB	376	BC341R	410	BC585R	421	BC915R	393
BC262R	385	BC343R	410	BC587R	421	BC916R	394
BC263B	377	BC344R	410	BC588R	421	BC917R	394
BC263R	385	BC345R	410	BC589R	421	BC919R	393
BC263W	388	BC346R	410	BC590R	420	BC920R	396
BC263WB	377	BC374R	411	BC591R	420	BC921R	396
BC265B	378	BC403R	408	BC592R	420	BC924R	394
BC265R	385	BC404R	408	BC597R	423	BC925R	394
BC265W	388	BC411R	409	BC600R	422	BC926R	394
BC265WB	378	BC413R	409	BC601R	422	BC927R	394
BC267W	389	BC414R	409	BC602R	422	BC930R	395
BC270R	385	BC415R	409	BC603R	422	BC931R	395
BC271B	377	BC416R	409	BC604R	422	BC933R	396
BC271R	385	BC417R	409	BC605R	422	BC934R	395
BC271W	388	BC421R	407	BC606R	422	BC935R	395

## Numerical Index – Nummerischer Index

## BC – BF

Cat. No. Art. Nr.	Page Seite	Cat. No. Art. Nr.	Page Seite	Cat. No. Art. Nr.	Page Seite	Cat. No. Art. Nr.	Page Seite
BC936R	395	BD213R	431	BD505R	177	BD667R	448
BC937R	395	BD215R	431	BD506R	446	BD668R	448
BC939R	393	BD216R	431	BD507R	446	BD669R	448
BC970R	425	BD217R	431	BD508R	446	BD670R	449
BC971R	425	BD220R	429	BD509R	445	BD671R	449
BC973R	425	BD221T	428	BD510R	445	BD690R	454
BC975R	425	BD222R	429	BD511R	445	BD692R	454
BC977R	425	BD223R	429	BD512R	445	BD700R	447
BC978R	425	BD224R	429	BD513R	446	BD701R	447
BC979R	425	BD225R	429	BD514T	428	BD702R	447
BC980R	425	BD226R	429	BD516T	428	BD725R	454
BC981R	425	BD227T	431	BD520R	446	BD726R	454
BC983R	425	BD228R	431	BD521R	446	BD735R	454
BC985R	425	BD229R	431	BD522R	446	BD736R	454
BC987R	425	BD230R	431	BD523R	446	BD750R	454
BC988R	425	BD231R	433	BD527R	451	BD755R	454
BC989R	425	BD232R	433	BD533R	451	BD760R	454
		BD236R	431	BD535R	451	BD870R	442
BD023R	434	BD238R	432	BD537R	451	BD878R	442
BD025R	434	BD239R	432	BD539R	451	BD879R	442
BD027R	434	BD243R	432	BD540R	451	BD880R	442
BD029R	434	BD246R	432	BD541R	451	BD883R	443
BD030R	434	BD250R	433	BD547R	452	BD885R	443
BD031R	434	BD257R	433	BD549R	452	BD886R	443
BD035R	435	BD260R	177	BD552R	451	BD887R	443
BD037R	435	BD261R	177	BD553R	451	BD888R	443
BD043R	434	BD264R	177	BD555R	451	BD900R	444
BD045R	434	BD268R	432	BD557R	451	BD902R	444
BD047R	434	BD269R	432	BD559R	451	BD903R	444
BD049R	434	BD301R	430	BD560R	451	BD904R	444
BD050R	434	BD302R	430	BD561R	451	BD905R	444
BD051R	434	BD303R	430	BD575R	452	BD910R	444
BD065R	435	BD304R	430	BD577R	452	BD911R	444
BD067R	435	BD305R	430	BD579R	452	BD952R	455
BD068R	435	BD311R	430	BD580R	452	BD963R	455
BD069R	435	BD312R	430	BD581R	452	BD964R	455
BD077R	435	BD313R	430	BD587R	453	BD965R	455
BD078R	435	BD314R	430	BD589R	453	BD980R	455
BD081R	433	BD315R	430	BD591R	453	BD992R	455
BD083R	435	BD320R	430	BD597R	453	BD993R	455
BD130R	435	BD321R	430	BD598R	453	BD995R	455
BD151R	440	BD329R	176	BD600R	452		
BD154R	440	BD330R	176	BD602R	453	BF003R	343
BD156R	440	BD331R	176	BD603R	453	BF004R	343
BD157R	440	BD333R	176	BD604R	453	BF006R	343
BD160R	441	BD335R	176	BD606R	453	BF008R	343
BD164R	441	BD336R	177	BD607R	453	BF010R	343
BD165R	441	BD337R	177	BD651R	450	BF016R	343
BD168R	441	BD338R	177	BD657T	431	BF021R	343
BD171R	441	BD340R	177	BD660R	449	BF027R	344
BD173R	441	BD343R	176	BD661R	449	BF032R	344
BD180R	441	BD345R	176	BD662R	449	BF033R	344
BD181R	441	BD500R	448	BD663R	449	BF040R	344
BD198R	441	BD501R	448	BD665R	448	BF041R	344
BD210R	430	BD502R	448	BD666R	448	BF046R	344

## Numerical Index – Nummerischer Index

BF – BJ

Cat. No. Art. Nr.	Page Seite	Cat. No. Art. Nr.	Page Seite	Cat. No. Art. Nr.	Page Seite	Cat. No. Art. Nr.	Page Seite
BF047R	344	BH017R	459	BH177R	474	BH448R	479
BF056R	346	BH018R	459	BH178R	475	BH449R	479
BF057R	346	BH020R	459	BH183R	476	BH450R	479
BF058R	346	BH021R	459	BH187R	476	BH451R	479
BF059R	346	BH022R	459	BH191R	477	BH610R	480
BF060R	345	BH023R	459	BH193R	477	BH612R	480
BF061R	345	BH026R	459	BH196R	477	BH614R	480
BF062R	345	BH027R	459	BH197R	477	BH615R	480
BF063R	345	BH030R	460	BH198R	475	BH618R	480
BF065R	345	BH031R	460	BH199R	475, 485	BH619R	480
BF070R	347	BH032R	460	BH200R	475	BH630R	480
BF071R	347	BH034R	460	BH201R	475	BH631R	480
BF076R	347	BH100R	470	BH202R	475	BH642R	481
BF077R	347	BH104R	470	BH203R	475	BH643R	481
BF078R	347	BH105R	470	BH205R	476	BH644R	481
BF112R	348	BH106R	471	BH206R	477	BH645R	481
BF113R	348	BH108R	470	BH207R	477	BH646R	481
BF116R	348	BH109R	470	BH209R	477, 488	BH647R	481
BF118R	348	BH110R	470	BH210R	476	BH648R	481
BF120R	348	BH111R	470	BH211R	476	BH649R	481
BF121R	348	BH114R	470	BH212R	475	BH650R	481
BF122R	348	BH115R	470	BH213R	475	BH651R	481
BF123R	348	BH118R	470	BH214R	476	BH800R	482
BF300R	492	BH119R	470	BH215R	476	BH801R	482
BF301R	492	BH120R	470	BH216R	477	BH804R	482
BF309R	135	BH121R	470	BH217R	477	BH805R	482
BF310R	135	BH123R	472	BH300R	342	BH807R	482
BF311R	135	BH124R	473	BH302R	342	BH808R	482
BF426R	351	BH125R	473	BH304R	342	BH902R	496
BF431R	351	BH126R	473	BH312R	342	BH906R	497
BF432R	351	BH127R	473	BH316R	342	BH908R	497
BF433R	351	BH130R	471	BH318R	342	BH949R	483
BF436R	351	BH131R	471	BH332R	478	BH951R	483
BF437R	351	BH134R	471	BH333R	478	BH952R	483
BF439R	352	BH135R	471	BH334R	478	BH957R	483
BF440R	352	BH139R	471	BH335R	478	BH959R	483
BF442R	352	BH140R	472	BH336R	478	BH961R	483
BF443R	352	BH141R	472	BH337R	478	BH963R	483
BF444R	351	BH143R	471	BH338R	478	BH965R	483
BF448R	351	BH144R	472	BH339R	478		
BF458R	354	BH145R	472	BH361R	478	BJ002R	484
BF459R	354	BH150R	472	BH410R	342, 349	BJ008R	484
BF460R	353	BH151R	472	BH412R	478	BJ009R	484
BF461R	353	BH154R	472	BH413R	478	BJ011R	484
BF463R	353	BH155R	472	BH414R	478	BJ012R	484
BF464R	353	BH160R	473	BH415R	478	BJ013R	485
BF465R	354	BH161R	473	BH422R	478	BJ014R	485
BF466R	354	BH164R	474	BH424R	478	BJ015R	485
		BH165R	474	BH425R	478	BJ016R	485
BH011R	459	BH166R	474	BH442R	479	BJ017R	485
BH012R	459	BH167R	474	BH443R	479	BJ018R	485
BH013R	459	BH168R	475	BH444R	479	BJ019R	486
BH014R	459	BH170R	473	BH445R	479	BJ020R	486
BH015R	459	BH171R	473	BH446R	479	BJ021R	486
BH016R	459	BH176R	474	BH447R	479	BJ022R	486

## Numerical Index – Nummerischer Index

## BJ – BT

Cat. No. Art. Nr.	Page Seite	Cat. No. Art. Nr.	Page Seite	Cat. No. Art. Nr.	Page Seite	Cat. No. Art. Nr.	Page Seite
BJ023R	486	BM032R	505	BM801R	510	BN400R	521
BJ024R	486	BM033R	505	BM802R	510	BN403	521
BJ025R	486	BM034R	505	BM806R	511	BN404	521
BJ026R	486	BM035R	505	BM807R	511	BN440R	521
BJ037R	489	BM044R	506	BM808R	511	BN452R	522
BJ038R	489	BM045R	506	BM809R	511	BN457R	522
BJ039R	489	BM046R	506	BM810R	510	BN460R	522
BJ050R	488	BM047R	506	BM811R	510	BN461R	522
BJ051R	488	BM054R	506	BM900R	513	BN465R	522
BJ057R	489	BM055R	506	BM901R	513	BN466R	522
BJ060R	490	BM056R	506	BM902R	513	BN467R	521
BJ061R	490	BM057R	506	BM905R	513	BN902R	523
BJ067R	488	BM058R	506	BM911R	514	BN903R	523
BJ080R	487	BM063R	505	BM913R	514	BN904R	523
BJ081R	487	BM064R	505	BM920R	514	BN905R	523
BJ082R	487	BM065R	503	BM922R	514	BN906R	523
BJ083R	487	BM066R	503	BM938P	514	BN907R	523
BJ086R	487	BM067R	503	BM940P	514	BN912R	523
BJ097R	484	BM074R	506	BM941P	514	BN913R	523
BJ098R	484	BM075R	506			BN914R	523
BJ100R	487	BM110R	266	BN003R	516	BN915R	523
BJ102R	487	BM111R	266	BN004R	516	BN916R	523
BJ103R	487	BM112R	266	BN006R	516	BN917R	523
BJ120R	489	BM124R	504	BN010R	516	BN922R	523
BJ121R	489	BM127R	504	BN012R	516	BN923R	523
BJ122R	489	BM128R	504	BN015R	516	BN924R	523
BJ300R	491	BM129R	504	BN020R	516	BN925R	523
BJ304R	491	BM132R	509	BN034R	517	BN926R	523
BJ305R	491	BM148R	509	BN036R	517	BN942R	523
BJ306R	491	BM149R	509	BN040R	517	BN943R	523
BJ308R	491	BM150R	509	BN054R	517	BN944R	523
		BM151R	509	BN063R	517	BN945R	523
BM001R	190	BM153R	509	BN064R	517	BN946R	523
BM002R	190	BM154R	509	BN066R	517	BN947R	523
BM003R	190	BM165R	509	BN068R	517		
BM004R	191	BM183R	508	BN070R	517	BT001R	313
BM005R	191	BM186R	508	BN090R	518	BT004R	315
BM008R	500	BM191R	508	BN104R	518	BT005R	312
BM009R	501	BM193R	508	BN110	518	BT006R	312
BM010R	500	BM196R	508	BN113R	518	BT007R	312
BM011R	501	BM301R	507	BN114R	518	BT008R	312
BM012R	501	BM302R	507	BN116R	518	BT010R	314
BM013R	502	BM325R	507	BN118R	518	BT011R	314
BM014R	501	BM327R	507	BN120R	518	BT012R	315
BM015R	502	BM385T	507	BN125R	518	BT019R	314
BM016R	502	BM386T	507	BN134R	518	BT020R	315
BM017R	502	BM387T	507	BN136R	518	BT021R	315
BM018R	502	BM560R	181	BN138R	518	BT022R	316
BM019R	502	BM562R	181	BN140R	518	BT025R	314
BM020R	503	BM563R	183	BN150R	518	BT026R	316
BM022R	503	BM564R	183	BN160	519	BT028R	317
BM023R	503	BM770R	512	BN170R	519	BT029R	317
BM024R	501	BM771R	512	BN172R	519	BT030R	317
BM025R	505	BM780R	512	BN175R	80	BT031R	317
BM026R	505	BM781R	512	BN184R	520	BT032R	317

## Numerical Index – Nummerischer Index

BT – BV

Cat. No. Art. Nr.	Page Seite	Cat. No. Art. Nr.	Page Seite	Cat. No. Art. Nr.	Page Seite	Cat. No. Art. Nr.	Page Seite
BT033R	317	BT183R	310	BT326R	326	BT949R	304
BT034R	319	BT184R	311	BT327R	328	BT951R	304
BT035R	319	BT185R	311	BT328R	328	BT958R	304
BT036R	319	BT187R	311	BT340R	328		
BT040R	320	BT190R	310	BT351R	332	BV001R	275
BT041R	321	BT192R	311	BT352R	332	BV002R	275
BT042R	320	BT193R	306	BT353R	332	BV003R	275
BT047R	321	BT194R	306	BT354R	327	BV005R	275
BT048R	321	BT195R	306	BT356R	327	BV006R	275
BT049R	321	BT196R	306	BT357R	327	BV007R	275
BT075R	291	BT197R	306	BT358R	327	BV028R	276
BT080R	291	BT198R	306	BT359R	327	BV030R	276
BT082R	291	BT199R	311	BT361R	327	BV032R	276
BT083R	291	BT221R	323	BT363R	327	BV033R	276
BT084R	293	BT222R	323	BT364R	327	BV066R	277
BT088R	293	BT223R	323	BT365R	327	BV067R	277
BT089R	293	BT224R	323	BT369R	331	BV068R	279
BT090R	293	BT225R	323	BT370R	331	BV070R	277
BT091R	293	BT227R	323	BT371R	331	BV071R	277
BT100R	298	BT228R	323	BT372R	331	BV072R	279
BT103R	298	BT229R	323	BT373R	331	BV073R	277
BT106R	298	BT230R	323	BT400R	333	BV074R	277
BT107R	298	BT232R	322	BT404R	334	BV075R	279
BT111R	299	BT234R	322	BT405R	334	BV076R	278
BT112R	299	BT238R	322	BT406R	334	BV077R	278
BT113R	299	BT239R	322	BT408R	334	BV078R	281
BT114R	299	BT240R	322	BT457R	310	BV079R	281
BT116R	299	BT241R	322	BT458R	310	BV084R	282
BT117R	299	BT242R	324	BT459R	337	BV085R	282
BT118R	299	BT243R	324	BT464R	335	BV086R	287
BT119R	299	BT244R	324	BT465R	336	BV087R	287
BT120R	296	BT246R	324	BT594R	337	BV088R	284
BT121R	299	BT248R	324	BT595R	337	BV090R	280
BT122R	299	BT252R	324	BT901R	300	BV091R	280
BT123R	299	BT253R	324	BT902R	300	BV092R	284
BT124R	299	BT254R	324	BT904R	300	BV093R	284
BT126R	299	BT256R	324	BT906R	300	BV094R	282
BT127R	299	BT257R	324	BT911R	301	BV097R	279
BT128R	299	BT258R	324	BT912R	301	BV098R	279
BT129R	299	BT259R	324	BT913R	301	BV099R	279
BT161R	307	BT260R	324	BT916R	301	BV101R	278
BT166R	307	BT261R	324	BT917R	301	BV104R	278
BT167R	307	BT265R	324	BT918R	301	BV105R	280
BT169R	308	BT293R	325	BT921R	301	BV106R	280
BT170R	308	BT294R	325	BT922R	301	BV243R	283
BT171R	308	BT295R	325	BT923R	301	BV427R	286
BT172R	308	BT296R	325	BT926R	301	BV428R	286
BT173R	305	BT311R	326	BT927R	301	BV432R	286
BT174R	305	BT315R	326	BT928R	301	BV433R	286
BT177R	305	BT316R	326	BT940R	303	BV434R	286
BT178R	305	BT320R	326	BT943R	303	BV996R	285
BT179R	305	BT321R	326	BT944R	303	BV997R	285
BT180R	309	BT322R	326	BT945R	303	BV998R	285
BT181R	309	BT323R	326	BT946R	303	BV999R	285
BT182R	310	BT325R	326	BT948R	304		

## Numerical Index – Nummerischer Index

BW – FA

Cat. No. Art. Nr.	Page Seite	Cat. No. Art. Nr.	Page Seite	Cat. No. Art. Nr.	Page Seite	Cat. No. Art. Nr.	Page Seite
BW080R	289	DO460R	330	DP011R	267	EA031R	494
BW081R	289	DO461R	330	DP031R	267	EA032R	494
BW085R	289	DO462R	330	DP035R	267	EA033R	494
BW086R	289	DO463R	330	DP121R	267	EA036R	496
BW087R	289	DO464R	330	DP501R	270	EA037R	496
BW088R	289	DO465R	330	DP505R	270	EA039R	496
BW090R	289	DO501R	202	DP520R	271	EA040R	496
BW091R	289	DO502R	202	DP530R	270	EA041R	496
BW092R	289	DO503R	202	DP540R	270	EA042R	496
BW093R	289	DO510R	209	DP541R	270	EA050R	495
BW094R	289	DO518R	212	DP551R	268	EA052R	495
		DO520R	205	DP552R	268	EA061R	495
DB020R	207	DO523R	211	DP560R	269	EA092R	495
DB022R	207	DO543R	205	DP561R	269	EA095R	495
DB025R	207	DO546R	209	DP563R	269	EA096R	495
DB086	234	DO547R	205	DP569R	269		
DB090	234	DO552R	205			EB001R	490
DB091	234	DO553R	205	DX050R	428	EB003R	490
DB095	234	DO606R	216	DX051R	428		
DB096	234	DO608R	219	DX052R	428	EJ126R	80
DB097	234	DO609R	219	DX055R	428	EJ305R	80
DB098	234	DO612R	208	DX105R	120	EJ315R	79
DB850R	207	DO642R	208	DX113	122	EJ316R	79
		DO650R	218	DX114	122	EJ317R	79
DF112R	236	DO651R	218	DX115	122	EJ318R	79
DF114R	237	DO655R	218	DX120R	122		
DF771R	529	DO656R	218	DX201R	207	EO164R	135
DF773R	529	DO670R	218	DX220R	218		
DF774R	529	DO671R	219	DX252R	241	FA001R	275
DF775R	529	DO672R	219	DX253R	241	FA005R	274
DF781R	529	DO673R	219	DX303R	180, 436	FA006R	274
DF783R	529	DO674R	219	DX305R	368	FA007R	274
DF784R	529	DO704R	105, 224	DX500R	244	FA025R	298
DF785R	529	DO706R	105, 224	DX501R	248	FA026R	298
		DO711R	227	DX545202	236	FA030R	88
DO208R	380	DO715R	227	DX545R	236	FA031R	88
DO209R	380	DO722R	230	DX601R	252	FA032R	88
DO210R	401	DO723R	230	DX800	111	FA033R	88
DO211R	401	DO732R	230	DX801R	110, 111	FA034R	88
DO218R	403	DO733R	230	DX802R	110, 111	FA035R	88
DO219R	405	DO750R	232	DX803R	111	FA036R	88
DO250R	380	DO751R	232	DX810R	110, 111	FA037R	88
DO251R	405	DO752R	232	DX811R	110, 111	FA038R	88
DO404R	306	DO753R	232			FA039R	88
DO432R	335	DO754R	232	EA010R	492	FA040R	88
DO438R	336	DO755R	232	EA012R	492	FA041R	86
DO439R	336	DO771R	241	EA013R	493	FA042R	86
DO440R	333	DO772R	241	EA014R	493	FA043R	86
DO441R	333	DO773R	241	EA015R	493	FA044R	86
DO450R	329	DO810R	239	EA016R	493	FA045R	86
DO451R	329	DO811R	239	EA017R	493	FA046R	86
DO452R	329	DO812R	239	EA020R	494	FA047R	87
DO453R	329	DO813R	239	EA025R	494	FA060R	87
DO454R	329	DO814R	239	EA026R	494	FA061R	87
DO455R	329			EA030R	494	FA062R	87

## Numerical Index – Nummerischer Index

FA – FD

Cat. No. Art. Nr.	Page Seite	Cat. No. Art. Nr.	Page Seite	Cat. No. Art. Nr.	Page Seite	Cat. No. Art. Nr.	Page Seite
FA063R	87	FB435R	462	FD023R	171	FD397R	292
FA064R	87	FB436R	462	FD028R	170	FD398R	292
FA065R	87	FB437R	462	FD045R	183	FD399R	292
FA066R	87	FB452R	466	FD046R	183	FD552R	192
FA067R	87	FB453R	466	FD048R	183	FD554R	192
FA068R	87	FB455R	466	FD076R	183	FD556R	192
FA069R	84	FB463R	467	FD079R	183	FD558R	192
FA070R	84	FB464R	467	FD080R	183	FD560R	192
FA071R	84	FB466R	467	FD081R	183	FD561R	192
FA072R	84	FB467R	467	FD100R	171	FD562R	192
FA073R	84	FB468R	467	FD101R	171	FD568R	193
FA074R	84	FB484R	465	FD103R	171	FD569R	193
FA075R	84	FB498R	465	FD113D	371	FD570R	194
		FB552R	466	FD114D	371	FD571R	194
FB130R	179	FB553R	466	FD115D	371	FD572R	194
FB328R	460	FB554R	466	FD116D	371	FD575R	195
FB329R	460	FB559R	464	FD137R	86	FD578R	193
FB330R	460	FB560R	464	FD138R	86	FD611R	194
FB331R	460	FB561R	464	FD139R	86	FD612R	194
FB362R	461	FB563R	464	FD220R	83	FD613R	194
FB363R	461	FB570R	464	FD222R	83	FD614R	194
FB364R	461	FB784R	439	FD224R	83	FD615R	194
FB365R	461	FB785R	439	FD226R	83	FD622R	198
FB366R	461	FB870R	251	FD228R	65,83	FD623R	198
FB367R	461	FB873R	251	FD230R	181	FD624R	198
FB369R	461	FB881R	251	FD231R	181	FD628R	198
FB382R	463	FB882R	251	FD232R	181	FD635R	195
FB383R	463	FB890R	251	FD233R	181	FD636R	195
FB385R	463	FB934R	494	FD240R	182	FD870R	196
FB387T	437	FB938R	493	FD241R	182	FD871R	196
FB388T	437			FD242R	182	FD872R	196
FB390T	437	FC330T	468	FD243R	182	FD873R	196
FB391T	437	FC331T	468	FD244R	182	FD874R	196
FB394R	438	FC337T	469	FD245R	182	FD875R	196
FB395R	438	FC338T	469	FD246R	182	FD876R	196
FB400R	438	FC339T	469	FD247R	182	FD877R	196
FB401R	439	FC340T	469	FD251R	173	FD878R	196
FB402R	438	FC341T	469	FD252R	173	FD879R	196
FB403R	439	FC342T	469	FD253R	180	FD880R	196
FB406R	439	FC343T	469	FD255R	180	FD881R	196
FB411R	438	FC411R	436	FD256R	180	FD882R	196
FB412R	438	FC412R	436	FD258R	185	FD883R	196
FB414R	438			FD259R	185	FD884R	196
FB415R	438	FD011R	170	FD280R	178	FD885R	196
FB420R	462	FD012R	170	FD281R	178	FD886R	196
FB421R	462	FD013R	170	FD284R	178	FD887R	196
FB422R	462	FD014R	170	FD285R	178	FD888R	196
FB423R	462	FD015R	170	FD286R	178	FD889R	196
FB424R	462	FD016R	170	FD287R	178	FD890R	196
FB425R	462	FD017R	170	FD375R	297	FD891R	196
FB426R	462	FD018R	171	FD376R	297	FD892R	196
FB427R	462	FD019R	171	FD392R	297	FD893R	196
FB432R	462	FD020R	171	FD394R	292	FD894R	196
FB433R	462	FD021R	171	FD395R	292	FD895R	196
FB434R	462	FD022R	171	FD396R	292	FD896R	197

## Numerical Index – Nummerischer Index

## FD – FK

Cat. No. Art. Nr.	Page Seite	Cat. No. Art. Nr.	Page Seite	Cat. No. Art. Nr.	Page Seite	Cat. No. Art. Nr.	Page Seite
FD897R	197	FF683R	264	FF914R	238	FK534R	207
FE005K	458	FF684R	264	FF915R	238	FK541R	207
FE010K	458	FF685R	264	FH605SU	63	FK543R	207
FE011K	458	FF692R	265	FH610R	64	FK552R	207
FE012K	458	FF693R	265	FH611R	64	FK611R	220
FE013K	458	FF694R	265	FH615	63	FK612R	220
FE014K	458	FF695R	265	FK110R	200	FK613R	220
FE020K	458	FF711R	265	FK120R	200	FK614R	220
FE021K	458	FF712R	265	FK121R	200	FK615R	220
FE022K	458	FF713R	265	FK124R	201	FK616R	220
FE023K	458	FF714R	265	FK130R	201	FK617R	220
FE024K	458	FF715R	264	FK131R	201	FK621R	220
FF168R	62	FF716R	265	FK133R	201	FK622R	220
FF266R	6	FF717R	264	FK139R	201	FK623R	220
FF270R	6	FF718R	265	FK141R	200	FK624R	220
FF275R	6	FF719R	265	FK291R	100, 206	FK625R	220
FF280R	62	FF720R	264	FK292R	100, 206	FK626R	220
FF313R	294	FF721R	265	FK293R	100, 206	FK627R	220
FF321R	294	FF722R	264	FK299R	208	FK630R	221
FF322R	294	FF723R	265	FK300R	209	FK631R	221
FF345R	85	FF724R	264	FK301R	210	FK632R	221
FF357R	63	FF725R	265	FK302R	210	FK633R	221
FF589R	82	FF726R	264	FK303R	209	FK634R	221
FF590B	82	FF727R	264	FK306R	212	FK635R	221
FF590R	82	FF728R	264	FK307R	212	FK636R	221
FF591R	82	FF729R	264	FK308R	212	FK637R	221
FF595R	82	FF734R	264	FK309R	212	FK638R	221
FF599R	85	FF737R	264	FK310R	209	FK639R	221
FF600R	85	FF738R	264	FK314R	211	FK650R	77
FF605R	85	FF739R	264	FK318R	210	FK651R	77
FF638R	264	FF741R	265	FK319R	210	FK652R	77
FF639R	264	FF742R	265	FK321R	210	FK653R	77
FF645R	264	FF743R	265	FK328R	211	FK654R	77
FF646R	264	FF745R	264	FK329R	211	FK658R	221
FF649R	264	FF746R	264	FK340R	213	FK659R	221
FF657R	264	FF747R	264	FK341R	213	FK660R	220
FF658R	264	FF748R	264	FK344R	213	FK661R	220
FF659R	264	FF749R	264	FK345R	213	FK662R	222
FF660R	264	FF750R	265	FK350R	213	FK663R	222
FF661R	264	FF751R	264	FK360R	214	FK664R	222
FF662R	264	FF752R	265	FK361R	214	FK665R	222
FF663R	264	FF753R	264	FK362R	210	FK675R	221
FF664R	264	FF754R	265	FK378R	214	FK676R	221
FF665R	264	FF755R	265	FK379R	214	FK677R	221
FF666R	264	FF769R	264	FK390R	214	FK678R	221
FF667R	264	FF770R	264	FK391R	214	FK679R	221
FF668R	264	FF771R	264	FK394R	211	FK684R	222
FF669R	264	FF772R	264	FK399R	214	FK685R	222
FF677R	264	FF773R	264	FK400R	215	FK686R	222
FF678R	264	FF777R	264	FK401R	215	FK800R	216
FF679R	264	FF781R	265	FK402R	215	FK801R	216
FF680R	264	FF782R	265	FK403R	215	FK803R	216
FF682R	264	FF783R	265	FK403R	215	FK813R	216
		FF784R	265	FK530R	207	FK814R	216
		FF785R	265	FK532R	207	FK817R	216
		FF913R	238				



## Numerical Index – Nummerischer Index

FK – FL

Cat. No. Art. Nr.	Page Seite	Cat. No. Art. Nr.	Page Seite	Cat. No. Art. Nr.	Page Seite	Cat. No. Art. Nr.	Page Seite
FK850R	216	FK927B	260	FK970R	262	FL118R	225
FK900B	260	FK927R	262	FK971B	260	FL120R	225
FK900R	262	FK928B	260	FK971R	262	FL122R	225
FK901B	260	FK928R	262	FK972B	260	FL124R	225
FK901R	262	FK930R	263	FK972R	262	FL126R	225
FK902B	260	FK931R	263	FK973B	260	FL128R	225
FK902R	262	FK932R	263	FK973R	262	FL130R	225
FK903B	260	FK933R	263	FK974B	260	FL132R	225
FK903R	262	FK934R	263	FK974R	262	FL134R	225
FK904B	260	FK936R	263	FK975B	260	FL136R	225
FK904R	262	FK937R	263	FK975R	262	FL138R	225
FK905B	260	FK938R	263	FK976B	260	FL144R	223
FK905R	262	FK939R	263	FK976R	262	FL146R	223
FK906B	260	FK940R	263	FK977B	260	FL148R	223
FK906R	262	FK941B	260	FK977R	262	FL153R	223
FK907B	260	FK943R	263	FK978B	260	FL173R	226
FK907R	262	FK944R	263	FK978R	262	FL174R	226
FK908B	260	FK945R	263	FK979B	260	FL175R	226
FK908R	262	FK946R	263	FK979R	262	FL176R	226
FK909B	260	FK948B	261	FK982B	260	FL183R	226
FK909R	262	FK948R	263	FK982R	262	FL184R	226
FK910B	260	FK949B	261	FK983B	260	FL185R	226
FK910R	262	FK949R	263	FK983R	262	FL186R	226
FK911B	260	FK950B	261	FK984B	260	FL187R	226
FK911R	262	FK950R	263	FK984R	262	FL213R	226
FK912B	260	FK951B	261	FK985B	260	FL214R	226
FK912R	262	FK951R	263	FK985R	262	FL215R	226
FK913B	260	FK952B	261			FL216R	226
FK913R	262	FK952R	263	FL034	235	FL223R	226
FK914B	260	FK953B	261	FL035R	235	FL224R	226
FK914R	262	FK953R	263	FL036R	235	FL225R	226
FK915B	260	FK954R	263	FL037	235	FL226R	226
FK915R	262	FK955R	263	FL038R	235	FL227R	226
FK916B	260	FK956R	263	FL039R	236	FL343R	227
FK916R	262	FK957R	263	FL044R	237	FL345R	227
FK917B	260	FK958R	263	FL045R	237	FL347R	227
FK917R	262	FK961B	260	FL047	237	FL380R	232
FK918B	260	FK961R	262	FL088R	228	FL381R	232
FK918R	262	FK962B	260	FL089R	228	FL382R	232
FK919B	260	FK962R	262	FL093R	238	FL383R	232
FK919R	262	FK963B	260	FL094R	238	FL384R	232
FK920B	260	FK963R	262	FL095R	238	FL390R	232
FK920R	262	FK964B	260	FL096R	238	FL391R	232
FK921B	260	FK964R	262	FL097R	238	FL392R	232
FK921R	262	FK965B	260	FL098R	238	FL393R	232
FK922B	260	FK965R	262	FL101R	228	FL394R	232
FK922R	262	FK966B	260	FL102R	228	FL401R	233
FK923B	260	FK966R	262	FL104R	228	FL402R	233
FK923R	262	FK967B	260	FL106R	228	FL403R	233
FK924B	260	FK967R	262	FL108R	228	FL405R	233
FK924R	262	FK968B	260	FL109R	228	FL406R	233
FK925B	260	FK968R	262	FL110R	225	FL407R	233
FK925R	262	FK969B	260	FL112R	225	FL408R	233
FK926B	260	FK969R	262	FL114R	225	FL411R	233
FK926R	262	FK970B	260	FL116R	225	FL412R	233

## Numerical Index – Nummerischer Index

## FL – GF

Cat. No. Art. Nr.	Page Seite	Cat. No. Art. Nr.	Page Seite	Cat. No. Art. Nr.	Page Seite	Cat. No. Art. Nr.	Page Seite
FL413R	233	FM043R	173	FM524R	186, 187	F0455R	246
FL415R	233	FM047R	180	FM525R	186, 187	F0457R	245
FL416R	233	FM061R	184	FM526R	186, 187	F0500R	247
FL417R	233	FM218R	186, 187	FM527R	186, 187	F0502R	247
FL418R	233	FM221R	186, 187	FM528R	186, 187	F0511R	247
FL503R	230	FM228R	186, 187	FM529R	186, 187	F0514R	247
FL504R	230	FM232T	167	FM530R	186, 187	F0515R	247
FL505R	230	FM233T	167	FM531R	186, 187	F0518R	247
FL506R	230	FM236R	185	FM540R	188, 189	F0520R	247
FL507R	230	FM238T	167	FM541R	188, 189	F0599R	243
FL512R	231	FM239T	167	FM542R	188, 189	F0601R	248
FL513R	231	FM252T	167	FM543R	188, 189	F0602R	248
FL514R	231	FM253T	167	FM545R	188, 189	F0604R	248
FL515R	231	FM258T	167	FM546R	188, 189	F0610R	250
FL516R	231	FM259T	167	FM547R	188, 189	F0611R	250
FL517R	231	FM276R	185	FM548R	188, 189	F0612R	250
FL523R	231	FM317T	166	FM563R	186, 187	F0614R	250
FL524R	231	FM318T	166	FM564R	186, 187	F0620R	249
FL525R	231	FM327T	166	FM565R	186, 187	F0622R	249
FL526R	231	FM328T	166	FM566R	186, 187	F0624R	249
FL527R	231	FM337T	166			F0626R	249
FL553R	231	FM338T	166	F0110R	253	F0632R	249
FL554R	231	FM388R	191	F0111R	253	F0634R	249
FL555R	231	FM390R	191	F0113R	254	F0636R	249
FL556R	231	FM430R	174	F0115R	254	F0640R	250
FL557R	231	FM431R	174	F0116R	254	F0641R	250
FL573R	231	FM432R	174	F0117R	254		
FL574R	231	FM433R	174	F0118R	254	GA059	552, 553
FL575R	231	FM434R	174	F0119R	254		
FL576R	231	FM435R	174	F0120R	252	GB600	552, 553
FL577R	231	FM436R	174	F0127R	252	GB600810	553
FL583R	231	FM437R	174	F0130R	252	GB600820	553
FL585R	231	FM438R	174	F0135R	253	GB600830	553
FL650R	230	FM439R	174	F0136R	253	GB600840	553
FL651R	230	FM440R	174	F0216R	249	GB600870	553
FL652R	230	FM441R	174	F0399R	243		
FL653R	230	FM442R	174	F0400R	243	GF350R	530
FL654R	230	FM444R	174	F0406R	243	GF351R	530
FL655R	230	FM481R	175	F0407R	243	GF352R	530
FL656R	230	FM482R	175	F0408R	243	GF353R	530
FL658R	230	FM483R	175	F0409R	243	GF354R	530
FL659R	230	FM484R	175	F0410R	244	GF355R	530
FL660R	230	FM485R	175	F0411R	244	GF360R	530
FL661R	230	FM486R	175	F0412R	245	GF361R	530
FL662R	230	FM488R	175	F0413R	244	GF362R	530
		FM503R	175	F0415R	245	GF363R	530
FM010R	172	FM504R	175	F0416R	245	GF364R	530
FM011R	172	FM505R	175	F0428R	245	GF365R	530
FM012R	172	FM506R	175	F0430R	245	GF370R	530
FM013R	172	FM507R	175	F0432R	245	GF371R	530
FM014R	172	FM508R	175	F0440R	246	GF372R	530
FM021R	184	FM520R	186, 187	F0442R	246	GF373R	530
FM040R	172	FM521R	186, 187	F0450R	246	GF374R	530
FM041R	172	FM522R	186, 187	F0451R	246	GF375R	530
FM042R	173	FM523R	186, 187	F0453R	246	GF380R	530

## Numerical Index – Nummerischer Index

GF – OF

Cat. No. Art. Nr.	Page Seite	Cat. No. Art. Nr.	Page Seite	Cat. No. Art. Nr.	Page Seite	Cat. No. Art. Nr.	Page Seite
GF381R	530	GF763R	44, 527	MB603R	517	OC020R	429
GF382R	530	GF764R	44, 527	MB741R	460	OC021R	429
GF383R	530	GF765R	44, 527	MB785R	332	OC022R	429
GF384R	530	GF766R	44, 527			OC024R	448
GF385R	530	GF767R	527	MD124R	534	OC025R	448
GF391R	531	GF768R	44, 528	MD125R	534	OC026R	448
GF392R	531	GF770R	44, 528	MD127R	534	OC051R	445
GF393R	531	GF771R	44, 527	MD129R	534	OC069R	429
GF394R	531	GF772R	43, 44, 526, 527	MD130R	534	OC091R	445
GF395R	531	GF773R	43, 44, 526, 527	MD452R	350	OC094R	445
GF396R	531	GF774R	43, 526, 527	MD453R	350	OC100R	447
GF397R	531	GF775R	527	MD454R	350	OC415R	412
GF398R	531	GF906R	536	MD463	450	OC430R	413
GF399R	531	GF907R	536	MD464	474	OC480R	168
GF401R	531	GF908R	536	MD465R	474	OC482R	168
GF402R	531	GF909R	536	MD466R	474	OC485R	168
GF403R	531	GF911R	540	MD467R	474	OC486R	168
GF404R	531	GF912R	540	MD468	474	OC491R	169
GF405R	531	GF913R	540	MD469	474	OC492R	169
GF406R	531	GF917R	529	MD497	321	OC496R	169
GF407R	531	GF918R	529	MD568	492	OC497R	169
GF408R	531	GF919R	535	MD569	485	OC498R	168
GF409R	531	GF923R	533	MD570R	485	OC500R	168
GF411R	531	GF925R	533	MD581	296		
GF412R	531	GF932R	534	MD617	246	OF001N	7
GF413R	531	GF933R	533	MD652	350	OF002N	7
GF414R	531	GF935R	535	MD653	350	OF003N	7
GF415R	531	GF936R	535	MD654	350	OF004N	7
GF416R	531	GF937R	534			OF005N	7
GF417R	531	GF938R	534	OA310R	309	OF006N	7
GF418R	531	GF939R	530	OA311R	309	OF010N	7
GF419R	531	GF940R	530	OA312R	309	OF015N	7
GF421R	531	GF941R	530	OA313R	309	OF016N	7
GF422R	531	GF942R	530	OA314R	309	OF017N	7
GF423R	531	GF944R	537	OA332R	294	OF018N	7
GF424R	531	GF946R	537	OA333R	294	OF019N	7
GF425R	531	GF947R	536	OA334R	294	OF031N	7
GF426R	531	GF980R	104, 539	OA335R	294	OF033N	7
GF427R	531			OA336R	294	OF043	5
GF428R	531	JF284R	111	OA337R	294	OF044	5
GF429R	531			OA338R	294	OF045	5
GF470R	532	JG598	234, 552, 553	OA340R	308	OF046	5
GF471R	532	JG600	552, 553	OA351R	296	OF047	5
GF472R	532	JG901	60, 61	OA357R	290	OF080	6
GF473R	532			OA358R	290	OF081	6
GF474R	532	LX150R	271	OA359R	290	OF093	4
GF475R	532	LX158R	271			OF094	4
GF476R	532	LX159R	271	OB510	519	OF095	4
GF477R	532	LX176R	266	OB511	519	OF096	4
GF478R	532			OB512	519	OF097	4
GF479R	532	MB229R	471	OB513	519	OF101C	2
GF480R	532	MB279R	213	OB514	519	OF102C	2
GF481R	532	MB285R	460	OB792R	96, 356	OF103C	2
GF756R	535	MB291R	447	OB793R	356	OF104C	2
GF757R	535	MB454R	447			OF108C	2

## Numerical Index – Nummerischer Index

## OF – OG

Cat. No. Art. Nr.	Page Seite	Cat. No. Art. Nr.	Page Seite	Cat. No. Art. Nr.	Page Seite	Cat. No. Art. Nr.	Page Seite
OF111C	2	OF295	4	OG003R	25	OG110R	34
OF112C	2	OF296	4	OG005R	25	OG112R	34
OF113C	2	OF297	4	OG006R	25	OG116R	35
OF114C	2	OF298	4	OG007R	27	OG123R	35
OF115C	2	OF300R	13	OG008R	27	OG124R	35
OF116C	2	OF303R	13	OG009R	27	OG125R	33
OF117C	2	OF313R	3	OG010R	27	OG126R	33
OF120C	2	OF314R	3	OG011R	28	OG127R	33
OF121C	2	OF315R	3	OG012R	28	OG128R	33
OF122C	2	OF316R	3	OG013R	28	OG129R	33
OF123C	2	OF317R	3	OG014R	28	OG131R	34
OF124C	2	OF350R	11	OG015R	29	OG132R	34
OF125C	3	OF351R	11	OG016R	28	OG133R	34
OF126C	3	OF352R	11	OG021R	29	OG136R	35
OF127C	3	OF353R	11	OG023R	30	OG140R	39
OF128C	3	OF354R	11	OG031R	30	OG141R	39
OF150	5	OF355R	11	OG034R	30	OG145R	39
OF151	5	OF356R	11	OG035R	29	OG150R	45
OF152	5	OF357R	11	OG036R	30	OG151R	45
OF153	5	OF358R	11	OG037R	30	OG160R	38
OF154	5	OF359R	11	OG038R	30	OG161R	38
OF155	5	OF360R	8	OG040R	31	OG162R	38
OF161	3	OF361R	10	OG042R	31	OG163R	38
OF162	3	OF403R	24	OG048R	36	OG164R	208
OF163	3	OF405R	24	OG050R	36	OG165R	208
OF164	3	OF407R	24	OG051R	36	OG178R	40, 217
OF250C	8	OF408R	92	OG053R	37	OG179R	40, 217
OF251C	8	OF410R	18	OG054R	37	OG180R	40, 217
OF252C	8	OF411R	18	OG055R	37	OG181R	41, 217
OF253C	8	OF414R	18	OG056R	37	OG182R	41, 217
OF254C	8	OF420R	18	OG060R	37	OG184R	41, 217
OF257R	520	OF423R	22	OG061R	37	OG185R	41, 217
OF259R	520	OF424R	22	OG066R	39	OG186R	40, 217
OF261R	520	OF425R	22	OG070R	26	OG189R	41, 217
OF262R	520	OF431R	24	OG071R	26	OG201R	42
OF266R	8	OF438R	21	OG072R	26	OG202R	42
OF267R	8	OF439R	21	OG073R	26	OG203R	42
OF268R	10	OF440R	21	OG074R	26	OG205R	42
OF270R	10	OF442R	21	OG075R	26	OG206R	42
OF271R	10	OF444R	21	OG080R	28	OG207R	42
OF272R	10	OF448R	22	OG081R	28	OG209R	42
OF274R	10	OF505R	13	OG082R	28	OG300R	23
OF277R	12, 291	OF528R	13	OG083R	28	OG301R	23
OF278R	12, 291	OF600R	9	OG084R	27	OG320R	45
OF279R	12, 291	OF601R	77, 140	OG085R	27	OG325R	16
OF282R	12, 290	OF608R	9	OG086R	27	OG329R	18
OF283R	12, 290	OF610R	9	OG099R	38	OG330R	16
OF284R	12, 290	OF614R	9	OG100R	31	OG331R	17
OF285R	12, 290	OF615R	9	OG101R	31	OG332R	17
OF288R	12, 290	OF618R	9	OG104R	31	OG334R	18
OF290	4	OF626R	9	OG105R	32	OG335R	16
OF291	4	OF760R	255	OG106R	32	OG338R	17
OF292	4			OG107R	32	OG339R	17
OF293	4	OG001R	25	OG108R	32	OG341R	19
OF294	4	OG002R	25	OG109R	32	OG342R	20

## Numerical Index – Nummerischer Index

OG – OL

Cat. No. Art. Nr.	Page Seite	Cat. No. Art. Nr.	Page Seite	Cat. No. Art. Nr.	Page Seite	Cat. No. Art. Nr.	Page Seite
OG343R.....	20	OK082R.....	55	OK405R.....	94	OK642R.....	70
OG344R.....	20	OK083R.....	55	OK410R.....	95	OK643R.....	70
OG345R.....	19	OK084R.....	55	OK412R.....	95	OK644R.....	70
OG346R.....	19	OK085R.....	57	OK422R.....	95	OK646R.....	70
OG348R.....	19	OK090R.....	56, 82	OK433R.....	71	OK647R.....	70
OG350R.....	14	OK091R.....	55	OK434R.....	71	OK680R.....	69
OG351R.....	14	OK092R.....	55	OK435R.....	71	OK681R.....	69
OG352R.....	14	OK093R.....	55	OK436R.....	71	OK682R.....	69
OG353R.....	14	OK094R.....	55	OK440R.....	71	OK683R.....	69
OG354R.....	15	OK099R.....	103	OK441R.....	71	OK684R.....	69
OG355R.....	14	OK100R.....	81	OK442R.....	71	OK690R.....	70
OG356R.....	15	OK101R.....	81	OK443R.....	71	OK704R.....	66
OG357R.....	15	OK102R.....	81	OK503R.....	74	OK711R.....	255
OG359R.....	23	OK103R.....	81	OK505R.....	72	OK712R.....	255
OG360R.....	23	OK105R.....	56	OK506R.....	72	OK737R.....	257
OG950R.....	43, 526	OK106R.....	56	OK507R.....	72	OK740R.....	256
OG951R.....	43, 526	OK107R.....	56	OK508R.....	72	OK741R.....	256
OG969R.....	43, 526	OK108R.....	56, 82	OK509R.....	72	OK742R.....	256
OG970R.....	43, 526	OK115R.....	58	OK520R.....	72	OK745R.....	257
OG971R.....	43, 526	OK116R.....	58	OK521R.....	72	OK794R.....	282
OG972R.....	43, 526	OK117R.....	58	OK522R.....	72	OK795R.....	282
OG973R.....	43, 526	OK118R.....	58	OK525R.....	75	OK800R.....	78, 331
OG974R.....	43, 526	OK161R.....	50	OK526R.....	75	OK804R.....	79
OG982R.....	43, 526	OK162R.....	50	OK527R.....	76	OK805R.....	79
OG983R.....	43, 526	OK163R.....	50	OK529R.....	76	OK811R.....	78
OG984R.....	43, 526	OK164R.....	50	OK530R.....	76	OK812R.....	78
		OK165R.....	50	OK531R.....	76	OK813R.....	78
OK001.....	96	OK166R.....	50	OK536R.....	74	OK814R.....	78
OK030R.....	54	OK167R.....	50	OK537R.....	74	OK815R.....	78
OK035R.....	57	OK225R.....	92	OK538R.....	75	OK816R.....	78
OK036R.....	57	OK226R.....	92	OK544R.....	73	OK874C.....	79
OK037R.....	51	OK242R.....	93	OK545R.....	73	OK875C.....	79
OK038R.....	51	OK243R.....	93	OK546R.....	73	OK876R.....	79
OK039R.....	51	OK245R.....	93	OK547R.....	73	OK877R.....	79
OK041R.....	53	OK260R.....	114	OK560R.....	65	OK900.....	80
OK042R.....	53	OK261R.....	114	OK561R.....	65	OK921R.....	80
OK043R.....	53	OK262R.....	114	OK562R.....	65	OK922R.....	80
OK047R.....	51	OK270R.....	114	OK580R.....	67	OK924R.....	80
OK048R.....	51	OK293R.....	114	OK581R.....	67	OK926R.....	80
OK049R.....	51	OK350R.....	90	OK582R.....	67		
OK051R.....	52	OK351R.....	90	OK583R.....	67	OL010R.....	113
OK052R.....	52	OK352R.....	90	OK584R.....	67	OL011R.....	113
OK053R.....	52	OK353R.....	91	OK600R.....	70	OL011R.....	442
OK058R.....	52	OK365R.....	413	OK602R.....	66	OL102R.....	97
OK060R.....	53	OK366R.....	414	OK603R.....	66	OL104R.....	97
OK061R.....	53	OK367R.....	413	OK606R.....	66	OL107R.....	97
OK062R.....	54	OK368R.....	413	OK607R.....	66	OL109R.....	98
OK070R.....	50	OK369R.....	413	OK608R.....	66	OL111R.....	98
OK071R.....	50	OK370R.....	91	OK609R.....	66	OL112R.....	98
OK072R.....	50	OK371R.....	91	OK612R.....	70	OL113R.....	98
OK073R.....	50	OK372R.....	413	OK613R.....	70	OL114R.....	97
OK076R.....	59	OK373R.....	413	OK620R.....	68	OL120R.....	96
OK077R.....	59	OK374R.....	412	OK621R.....	68	OL140R.....	212
OK078R.....	59	OK378R.....	248	OK622R.....	68	OL141R.....	212
OK081R.....	55	OK400R.....	94	OK641R.....	70	OL142R.....	212

## Numerical Index – Nummerischer Index

## OL - OM

Cat. No. Art. Nr.	Page Seite	Cat. No. Art. Nr.	Page Seite	Cat. No. Art. Nr.	Page Seite	Cat. No. Art. Nr.	Page Seite
OL143R	212	OL304R	106, 228	OL403R	240	OM049R	123
OL151R	99, 203	OL305R	106, 229	OL405R	241	OM061R	124
OL152R	99, 203	OL307R	106, 229	OL406R	241	OM062R	124
OL153R	99, 203	OL311R	223	OL407R	240	OM063R	124
OL154R	100, 206	OL314R	223	OL408R	240	OM070R	124
OL155R	101, 204	OL316R	223	OL409R	240	OM071R	124
OL157R	211	OL318R	105, 223	OL410R	240	OM072R	124
OL159R	101, 204	OL319R	108, 229	OL411R	240	OM073R	124
OL160R	202	OL320R	108, 229	OL412R	240	OM078R	152
OL161R	211	OL321R	105, 224	OL413R	240	OM079R	152
OL162R	202	OL322R	105, 224	OL421R	242	OM080R	152
OL163R	202	OL323R	105, 224	OL423R	242	OM081R	152
OL164R	100, 206	OL326R	105, 224	OL425R	242	OM082R	152
OL165R	100, 206	OL327R	105, 224	OL427R	242	OM083R	152
OL166R	100, 206	OL328R	105, 224	OL429R	242	OM084R	152
OL168R	104, 538	OL329R	105, 224	OL448R	99	OM085R	152
OL169R	203	OL331R	108, 229	OL451R	99	OM086R	152
OL170R	100, 206	OL332R	108, 229	OL452R	99	OM087R	152
OL171R	101, 204	OL333R	108, 229	OL460R	109	OM088R	152
OL177R	104, 538	OL335R	107, 225	OL461R	109	OM089R	152
OL179R	101, 204	OL336R	107, 225	OL470R	112	OM090R	152
OL180R	210	OL338R	105, 224	OL471R	112	OM101R	130
OL187R	529	OL339R	105, 224	OL472R	112	OM102R	130
OL192R	208	OL341R	225	OL473R	112	OM103R	130
OL195R	104, 539	OL342R	225	OL474R	113	OM104R	125
OL196R	104, 539	OL343R	225	OL477R	113	OM105R	124
OL198R	202	OL344R	227	OL479R	113	OM111R	131
OL201R	307	OL345R	227	OL601R	295	OM112R	131
OL202R	102, 302	OL346R	227	OL602R	295	OM113R	131
OL203R	102, 302	OL347R	227	OL603R	295	OM114R	131
OL204R	102, 302	OL348R	227	OL610R	295	OM115R	131
OL206R	297	OL349R	227	OL611R	296	OM116R	126
OL207R	297	OL350R	227	OL612R	296	OM118R	126
OL210R	102, 302	OL354R	96	OL614R	297	OM119R	126
OL211R	309	OL355R	96	OL615R	295	OM150R	133
OL212R	309	OL356R	96	OL616R	295	OM151R	133
OL214R	102, 302	OL360R	226	OL617R	295	OM152R	133
OL218R	103	OL361R	226	OL619R	295	OM153R	133
OL219R	318	OL362R	226	OL620R	296	OM154R	132
OL220R	318	OL363R	226	OL621R	295	OM155R	132
OL221R	320	OL366R	226	OL622R	296	OM156R	132
OL270R	106, 228	OL367R	226	OL623R	296	OM157R	132
OL271R	106, 228	OL368R	226	OL624R	296	OM158R	132
OL272R	106, 228	OL369R	226	OL626R	295	OM169R	125
OL273R	106, 228	OL370R	226	OL627R	295	OM170	125
OL274R	106, 228	OL371R	226	OL670R	115	OM171R	127
OL275R	106, 228	OL385R	233	OL699R	98	OM172R	127
OL294R	106, 228	OL386R	233			OM173R	127
OL296R	106, 228	OL387R	233	OM030R	121	OM174R	127
OL298R	106, 228	OL390R	107, 229	OM038R	121	OM175R	127
OL299R	106, 228	OL391R	107, 229	OM040R	121	OM176R	128
OL300R	106, 228	OL392R	107, 229	OM041R	121	OM177R	128
OL301R	106, 228	OL393R	107, 229	OM044R	123	OM178R	128
OL302R	106, 228	OL394R	107, 229	OM047R	123	OM179R	125
OL303R	106, 228	OL401R	240	OM048R	123	OM181R	129

## Numerical Index – Nummerischer Index

OM - TE

Cat. No. Art. Nr.	Page Seite	Cat. No. Art. Nr.	Page Seite	Cat. No. Art. Nr.	Page Seite	Cat. No. Art. Nr.	Page Seite
OM182R	129	OM510R	147	OP030R	538	OP914	58
OM183R	129	OM511R	147	OP031R	538	OP923	58
OM185R	134	OM512R	147	OP100R	160	PE487A	64
OM186R	134	OM513R	147	OP111R	160	PE507A	64
OM187R	134	OM514R	147	OP112R	160	RT020R	61
OM202R	118, 520	OM520R	148	OP113R	160	RT040R	60
OM203R	118	OM521R	148	OP114R	160	RT043R	60
OM205R	118	OM522R	148	OP120R	161	RT044SU	60
OM208R	118	OM523R	148	OP130R	161, 249	RT090R	60
OM212R	118	OM524R	148	OP280R	153	RT099R	63
OM220R	119	OM602R	135	OP281R	153	SF811R	541
OM221R	119	OM611R	136	OP282R	153	SF812R	541
OM222R	119	OM612R	136	OP290R	153	SF813R	541
OM230R	120	OM613R	136	OP292R	153	SL002R	542
OM235R	120	OM616R	137	OP293R	153	SL017R	543
OM236R	119	OM617R	137	OP294R	153	SL018R	542
OM237R	119	OM618R	137	OP295R	153	SL022R	542
OM251R	313	OM637R	140	OP297R	154	SL028R	543
OM252R	313	OM640R	118	OP298R	154	SL032R	543
OM253R	313	OM660R	138	OP299	154	SL033R	543
OM307R	200	OM661R	138	OP300R	155	SL034R	543
OM308R	200	OM663R	139	OP301R	155	SL118R	542
OM309R	208	OM664R	139	OP302R	155	SL122R	542
OM311R	209	OM665R	139	OP304R	156	SP333	541
OM314R	209	OM666R	139	OP305R	156	SP336	541
OM315R	209	OM668R	138	OP306R	156	TA005771	121
OM391R	149	OM669R	138	OP307R	156	TA009706	121
OM392R	149	OM670R	539	OP310R	156	TE683R	58
OM393R	149	OM671R	537	OP311R	156	TE684R	58
OM396R	149	OM672R	536	OP312R	156	TE688R	58
OM397R	149	OM680R	140	OP313R	156	TE888	111
OM398R	149	OM681R	140	OP316R	157		
OM451R	146	OM688R	140	OP320R	157		
OM452R	146	OM700R	141	OP325R	157		
OM453R	146	OM707R	141	OP360R	538		
OM454R	146	OM710R	141	OP361R	538		
OM455R	146	OM711R	141	OP362R	538		
OM456R	146	OM750R	143	OP365	541		
OM471R	147	OM751R	143	OP380R	159		
OM472R	147	OM757R	143	OP386R	158		
OM473R	147	OM758R	143	OP387R	158		
OM474R	147	OM760R	142	OP388R	158		
OM486R	519	OM760SU	142	OP389R	158		
OM488	519	OM761R	142	OP390R	158		
OM489R	404	OM768R	142	OP392R	158		
OM490R	150	OM776R	144	OP396R	158		
OM496R	150	OM781R	144	OP402R	157		
OM498R	150	OM801R	145	OP403R	158		
OM499R	150	OM802R	145	OP405R	158		
OM500R	146	OM803R	145	OP406R	158		
OM501R	146	OM806R	145	OP407R	158		
OM502R	146	OM902R	145	OP408R	158		
OM503R	146	OM903R	145	OP409R	158		
OM504R	146	OM915R	144	OP906	58		
OM505R	146	OM917R	144	OP913	58, 154		

## Numerical Index – Nummerischer Index













